



TRUE MANUFACTURING CO., INC.  
U.S.A. FOODSERVICE DIVISION

2001 East Terra Lane • O'Fallon, Missouri 63366-4434 • (636)240-2400  
Fax (636)272-2408 • Toll Free (800)325-6152 • Intl Fax# (001)636-272-7546  
Parts Dept. (800)424-TRUE • Parts Dept. Fax# (636)272-9471 • www.truemfg.com

Project Name: \_\_\_\_\_

Location: \_\_\_\_\_

Item #: \_\_\_\_\_ Qty: \_\_\_\_\_

Model #: \_\_\_\_\_

A/A #

S/S #

Model:

**TMC-49-S-SS-HC**

**Milk Coolers:**

*Stainless Steel Exterior/Stainless Steel Interior with Hydrocarbon Refrigerant*



**TMC-49-S-SS-HC**

- ▶ True's commitment to using the highest quality materials and oversized refrigeration systems provides the user with colder product temperatures, and lower utility costs in an attractive, durable school milk cooler.
- ▶ Factory engineered, self-contained, capillary tube system using environmentally friendly R290 hydro carbon refrigerant that has zero (0) ozone depletion potential (ODP), & three (3) global warming potential (GWP).
- ▶ High capacity, factory balanced, forced-air refrigeration system maintains milk temperatures of 33°F to 38°F (.5°C to 3.3°C). Colder holding temperatures provide better tasting milk, increased sales and less product waste.
- ▶ Exterior - all stainless steel exterior front, sides, back and top.
- ▶ All stainless steel self-service doors feature convenient drop front and "hold-open" flip-up top. Standard with door locks.
- ▶ Interior - Stainless steel walls and reinforced floor.
- ▶ Standard with heavy duty floor racks and convenient clean out drain.
- ▶ Designed to hold Twelve 13"L x 13"D x 11 1/8"H (331 mm x 331 mm x 296 mm) milk crates.
- ▶ Entire cabinet structure is foamed-in-place using a high density, polyurethane insulation that has zero ozone depletion potential (ODP) and zero global warming potential (GWP).

**ROUGH-IN DATA**

Specifications subject to change without notice.  
Chart dimensions rounded up to the nearest 1/8" (millimeters rounded up to next whole number).

Model	Doors	Capacity Crates	Crate Dimensions (inches) (mm)			Floor Racks	Cabinet Dimensions (inches) (mm)			HP	Voltage	Amps	NEMA Config.	Cord Length (total ft.) (total m)	Crated Weight (lbs.) (kg)
			W	D	H		W**	D†	H*						
TMC-49-S-SS-HC	2	12	13 331	13 331	11 1/8 296	3	49 1245	33 839	41 1/8 1058	1/8 N/A	115/60/1	2.7 N/A	5-15P	9 2.74	430 195

\*\* Width does not include 1/8" (4 mm) each side for lid pins.

† Depth does not include 1" (26 mm) for front bumpers. Depth does not include 1" (26 mm) for rear bumpers.

\* Height does not include 5 1/8" (130 mm) for castors.



APPROVALS:

AVAILABLE AT:

6/18-A

Printed in U.S.A.

Model:  
**TMC-49-S-SS-HC**

**Milk Coolers:**  
*Stainless Steel Exterior/Stainless Steel Interior  
with Hydrocarbon Refrigerant*



**STANDARD FEATURES**

**DESIGN**

- True's commitment to using the highest quality materials and oversized refrigeration systems provides the user with colder product temperatures, and lower utility costs in an attractive, durable school milk cooler.

**REFRIGERATION SYSTEM**

- Factory engineered, self-contained, capillary tube system using environmentally friendly R290 hydro carbon refrigerant that has zero (0) ozone depletion potential (ODP), & three (3) global warming potential (GWP).
- High capacity, factory balanced refrigeration system that maintains cabinet temperatures of 33°F to 38°F (.5°C to 3.3°C) provide better tasting milk, increased sales and less product waste.
- State of the art, electronically commutated evaporator and condenser fan motors. ECM motors operate at higher peak efficiencies and move a more consistent volume of air which produces less heat, reduces energy consumption and provides greater motor reliability.
- Condensing unit accessed from behind back grill, slides out for easy cleaning and maintenance.

**CABINET CONSTRUCTION**

- Exterior - all stainless steel front, sides, back and top.
- Interior - Stainless steel walls and reinforced floor. Standard with heavy duty floor racks.
- Insulation - entire cabinet structure is foamed-in-place using a high density, polyurethane insulation that has zero ozone depletion potential (ODP) and zero global warming potential (GWP).
- Welded, heavy duty steel frame rail, black powder coated for corrosion protection.
- Frame rail fitted with four (4) easy roll, 4" (102 mm) diameter swivel castors (front castors lock in place).
- Designed to hold Twelve 13"L x 13"D x 11 1/8"H (331 mm x 331 mm x 296 mm) milk crates.

**DOORS**

- All stainless steel self-service doors feature convenient drop front and "hold-open" flip-up top. Door support bumpers standard.
- Door locks standard.
- Magnetic door gaskets of one piece construction, removable without tools for ease of cleaning.

**MODEL FEATURES**

- Exterior digital temperature display.

- Evaporator is epoxy coated to eliminate the potential of corrosion.
- Convenient clean out drain with 1/2" (13 mm) NPT-PVC drain plug.
- Wide gaskets.
- This unit is Energy Star 4.0 Rated and meets Department of Energy 2017 standards.
- Listed under NSF/ANSI Standard 7 for the storage and/or display of packaged or bottled product.

**ELECTRICAL**

- Unit completely pre-wired at factory and ready for final connection to a 115/60/1 phase, 15 amp dedicated outlet. Cord and plug set included.



115/60/1  
NEMA-5-15R

**OPTIONAL FEATURES/ACCESSORIES**

Upcharge and lead times may apply.

- 6" (153 mm) standard legs (mounting plates required).
- 6" (153 mm) seismic/flanged legs (mounting plates required).
- Corner bumpers.

**PLAN VIEW**

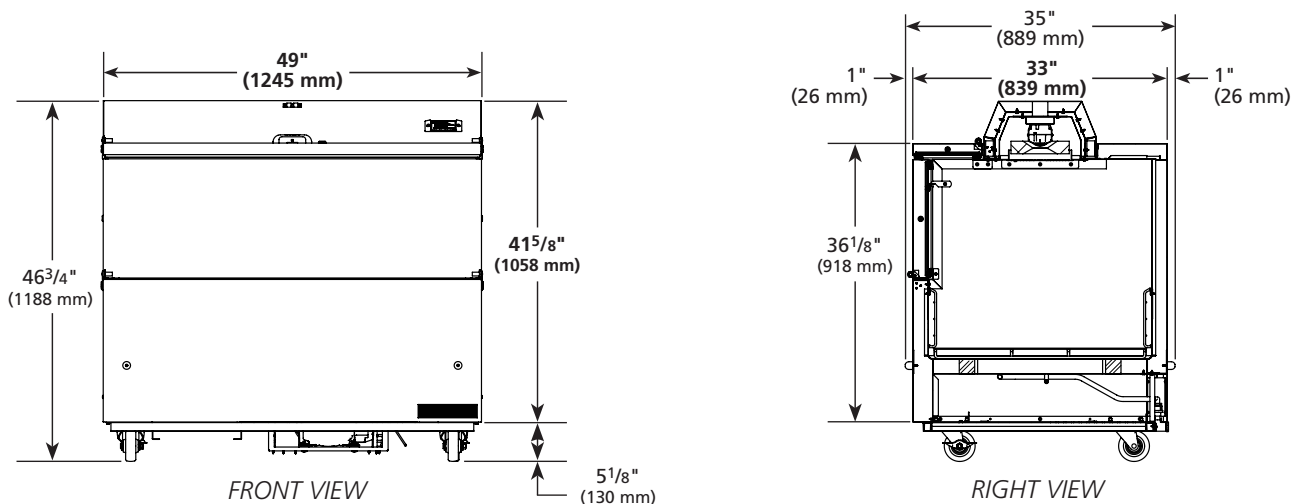

**WARRANTY**  
 Three year warranty on all parts and labor and an additional 2 year warranty on compressor. (U.S.A. only)

METRIC DIMENSIONS ROUNDED UP TO THE NEAREST WHOLE MILLIMETER  
 SPECIFICATIONS SUBJECT TO CHANGE WITHOUT NOTICE



Model	Elevation	Right	Plan	3D	Back
TMC-49-S-SS-HC	TFQ060E	TFQ060S	TFQ060P	TFQ0603	

**TRUE MANUFACTURING CO., INC.**