

P R O D U C T C A T A L O G

PROFESSIONAL GRADE EQUIPMENT

True, the most trusted brand in commercial refrigeration



T R U E M I S S I O N



To help our customers
live confidently

A HISTORY OF REFRIGERATION EXCELLENCE

1945
50

1960
70

1980
90



1940's

Bob, Frank & Art Trulaske develop the first Upright Freezer in their garage and True Refrigeration is born.



1960's

New GDM® Upright Glass Door Merchandiser's developed and bottler business continues to grow.



1980's

Continued success in the Foodservice industry backed by two core models, T-Series® Traditional Reach-In and the Sandwich/Salad Food Prep Tables.

1950's

Roll-Top units become more popular and True expands into international sales with coolers sold in the Caribbean and Central America.

1970's

True enters the Foodservice industry and develops new fan motor technology.



2000
10

2020
TODAY



1990's

Orders from U.S. chain accounts continue to grow and walls fall in Berlin accelerating True's growth internationally.



2010's

True introduces Curved Glass Display Merchandisers and unveils a state-of-the-art powder coating facility offering a customized look to True's lineup.

2020 - Today

True introduces Premier Bar Series and offer new Grab N Go® Open Air Merchandisers.

2000's

True introduces Spec Series® lineup and pioneers a more efficient and sustainable R290 Hydrocarbon refrigerant.



2024
Commercial Ice Machines
.....
True Retail Merchandisers





Sustainability

P L E D G E

True is committed in our efforts toward becoming a more sustainable entity and reducing our overall carbon footprint. We pledge to all of our employees and customers that we will continually search for eco-friendly components and processes that will help minimize the environmental impact of our company.

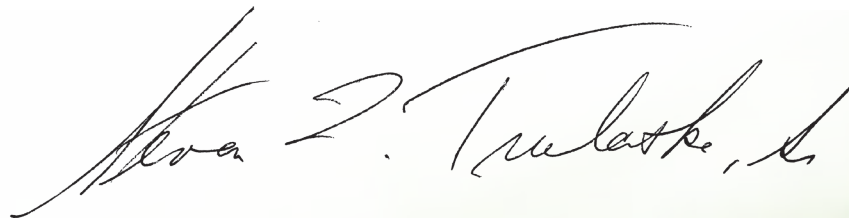

STEVEN L. TRULASKE Sr.

Owner/CEO



LEARN MORE

TRUE SETS THE STANDARD

You can trust that we do our part and more. Not only do we meet sustainability standards, we consistently surpass them. As Energy Star Partners, we take responsibility in leading the charge with green innovation. It's our duty as the largest commercial refrigeration manufacturers worldwide to ensure that our innovations in refrigeration are making the world a better place.

INNOVATION MEETS SUSTAINABILITY



RCU Technology

This envy of the industry comes standard in every True product. Our patented Reverse Condensing Fan Motor reduces energy consumption and holds the coolest temperatures – all while removing excess debris from the interior and surface of the condensing coil to increase its lifetime.



Lower Energy Cost

TRUE's vertically integrated higher-quality components mean less failure rate, shorter run times, and lower energy consumption. Coupled with the industry's in-class warranty means lower operating costs for you and an overall lifetime cost for your commercial refrigeration.



Sustainable Foam

Foamed in place, CFC-free, polyurethane, high-density insulation that provides unparalleled strength, rigidity, and increase to an already industry-exceeding insulation factor, with zero ozone depletion potential (ODP) and zero global warming potential (GWP).

TRUE IS PRIMED TO BE A ZERO WASTE FACILITY BY 2027

TRUE'S Green Promise, we are continually searching out environmentally friendly components and processes that will reduce our carbon footprint. This process encapsulates both our approach to manufacturing as well as our approach to the performance of our equipment. True is meeting and exceeding CEC and DOE energy standards without sacrificing quality. Solar Initiatives; True produces 700,000 kilowatt hours of energy – equal to reducing carbon emissions by 495 tons annually. Our 23 solar arrays are home to 2,070 solar panels and are seamlessly integrated into the Ameren Missouri power grid.

**PROUD WINNER
OF THE
2024**

Energy Star Partner of the Year
Sustained Excellence Award



**PARTNER OF THE YEAR
Sustained Excellence**

"True is committed to being a sustainable and responsible business. We seek eco-friendly components and processes to minimize the environmental impact of our operations and products."

– STEVE YOUNG
Director of Operations

RECOGNITION IN SUSTAINABLE INITIATIVES



the True difference



HC Refrigeration

By matching and balancing hydrocarbon refrigeration with the latest refrigeration components, True engineers environmentally friendly refrigeration systems with shorter run times, lower energy consumption, and the industry's coldest holding temperatures.



Designed in the USA

True is committed to producing high-quality products that are designed in the USA. True manufactures each cabinet using an industry-leading combination of high-quality metals and components designed to optimize cabinet performance.



Quality Components

True uses quality components to ensure a long life of refrigeration with minimal energy consumption.



Energy Efficiency

True is committed to eco-friendly manufacturing by meeting and surpassing energy standards while not sacrificing performance. By using oversized, higher-capacity, balanced refrigeration systems, True outperforms industry efficiency expectations.



High Density Insulation

True continues its commitment to sustainability with the use of foamed-in-place, CFC-free, polyurethane, high-density insulation that provides unparalleled strength and rigidity. In addition, an increase to an already industry-exceeding insulation factor, with zero ozone depletion potential (ODP) and zero global warming potential (GWP).



PVC Coated Shelving

True internally manufacture their own heavy-duty shelves utilizing larger diameter steel for strength with ½" spacing on top support bars for ease of use. The shelves are then bonded with powdered PVC to prevent chipping and peeling, which is prevalent in competitors' standard epoxy-coated shelves.



100% Run Testing

In order to verify that all units are manufactured properly and to spec, True runs tests on every single unit as part of the final quality inspection before releasing the unit into the finished goods inventory.



Abundant Availability

In its Missouri-based manufacturing facilities, True builds for inventory to provide a near 100% fill rate on standard items. This allows for the most optimal turnaround when the purchase order is received and processed.



After Sale Support

True's USA and Canada Foodservice warranties are the envy of the industry. At no additional cost, our customers enjoy the option of having the entire condensing unit replaced. This consists of a new compressor, condenser, start components, and fan motor, all of which are pre-assembled and shipped from the factory.



Manufacturing independence

True has complete control of manufacturing processes by investing in vertical integration. This allows us to streamline operations and take direct ownership of various stages in the production process rather than relying on international suppliers.



[LEARN MORE](#)

Vertically Integrated Processes

The customer gets the highest level product, direct, quick and at the best value.





STANDARD FOR ALL HC MODELS



Coldest
Temperatures
Freshest
Products



Increased
Life
Span!



20%
Less Energy
Consumption



A standard condensing unit works by drawing air through the condenser coil, cooling the refrigerant and the compressor.

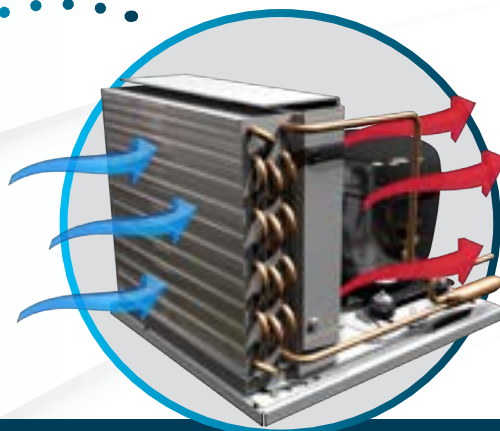



**SELF
CLEANING
TECHNOLOGY**

ELIMINATES
THE NEED TO CLEAN THE
CONDENSER COIL THROUGH
THE FULL WARRANTY

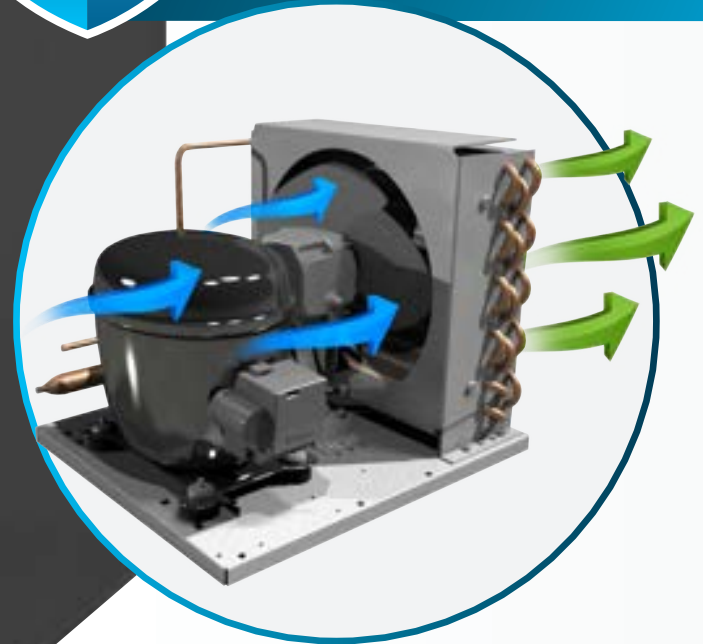

True's Self Cleaning Reverse Condensing Unit technology works by reversing the fan direction upon each startup of the unit, which causes air to blow through the condensing coil and effectively removes any dirt, dust, or debris.



LEARN MORE

Production/Satellite Facilities

World Headquarters O'Fallon, MO





Bowling Green Plant – Bowling Green, MO



Mexico, Missouri Plant – Mexico, MO



Pacific Plant – Pacific, MO



Monterrey, Nuevo León, Mexico

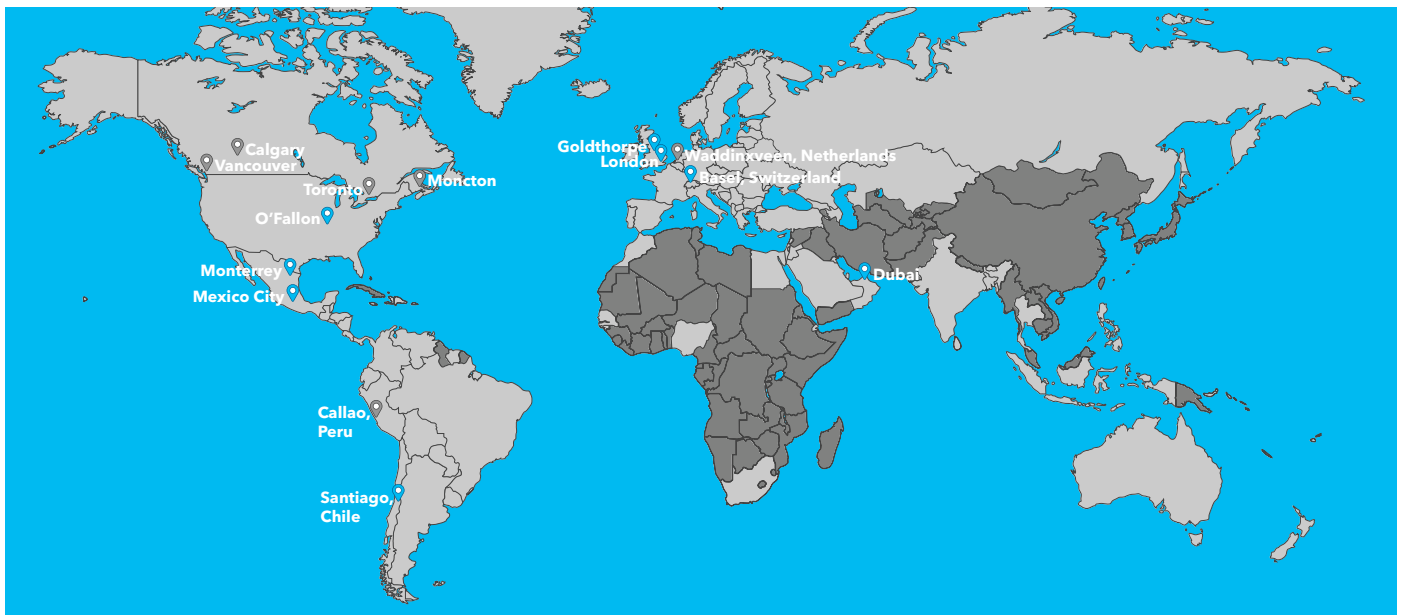

Equipment supplied and actively supported in over 100 countries around the world



Office & Distribution



Warehousing

Table of Contents



Reach-In Refrigeration

19

T-Series® Reach-In Refrigerators	24
T-Series® Pass-Thru Refrigerators.....	24
TSD-Series Slide Door Refrigerators	26
TS Series Reach-In Refrigerators.....	28
TGN® Reach-In Refrigerators	30
STR/STA/STG Reach-In Refrigerators	32
STR/STA/STG Pass-Thru Refrigerators	34
STR/STA/STG Roll-In Refrigerators	36
STR/STA/STG Roll-Thru Refrigerators	36
T-Series® Traditional Reach-In Freezers	38
T-Series® Convertible Reach-In Freezers	38
TS Series Reach-In Freezers.....	40
TS Series Convertible Reach-In Freezers	40
TGN® Reach-In Freezers	42
STR/STA/STG Reach-In Freezers.....	44
STR/STA/STG Pass-Thru Freezers	44
STR/STA/STG Roll-In Freezers.....	46
DT Series Dual Temperature	48
STR/STA/STG Dual Temperature	50



Food Prep Tables

52

TSSU® Sandwich/Salad Units.....	54
TSSU® Mega-Top Sandwich/Salad Units	56
TSSU®~SPEC3 Sandwich/Salad Units	58
TSSU® Mega Top~SPEC3 Sandwich/Salad Units.....	60
TSSU® ADA Compliant Packages & ~SPEC3 ADA	62
TSSU® Mega Top ADA Compliant Packages & ~SPEC3 ADA	62
TFP™ Food Prep Units & TFP~SPEC3.....	64
TPP® Pizza Prep Tables & TPP~SPEC3	66
TPP® Pizza Prep Tables & TPP~SPEC3 ~Heavy Gauge Top Package (~HGTP).....	68



Undercounters & Worktops

70

TUC® Undercounter Refrigerators	74
TFT™ Undercounter Flat Top Refrigerators	74
TUC® Deep Undercounter Refrigerators.....	76
TUC® Undercounter Refrigerators~SPEC3.....	78
TUC® Undercounter Deep Refrigerators~SPEC3.....	80
TUC® Undercounter Freezers	82
TUC® Undercounter Convertible Freezers.....	82
TUC® Deep Undercounter Freezers.....	84
TUC® Undercounter Freezers~SPEC3	86
TUC® Undercounter Deep Freezers~SPEC3	88
TUC® Undercounter ADA Compliant Packages	90
TUC® Undercounter ADA Compliant~SPEC3 Packages.....	90
TUC® Undercounter Low Profile Castors.....	90
TUC® Undercounter Low Profile ~SPEC3 Castors.....	90
TWT™ Worktop Refrigerators	94
TWT™ Worktop Deep Refrigerators	96
TWT™ Worktop Refrigerators ~SPEC3	98
TWT™ Worktop Deep Refrigerators ~SPEC3	100
TWT™ Worktop Freezers	102
TWT™ Worktop Deep Freezers	104
TWT™ Worktop Freezers~SPEC3.....	106
TWT™ Worktop Deep Freezers~SPEC3	108
TWT™ Worktop ADA Compliant Packages.....	110



Chef Bases

112

TRCB™ Chef Base Refrigerators	114
TRCB™ Chef Base Refrigerators ~SPEC3.....	114



Merchandisers

116

CVM Contemporary Visual Merchandiser ..	120
GDM® Swing Door Refrigerators	122
GDM® Freezers & Ice Merchandisers	124
GDM® Convertible Freezers	124
GDM® Slide Door Refrigerators	126
GDM® Convenience Store Refrigerators.....	128
GDM® Counter-Top Refrigerators.....	128
GEM Glass End Merchandisers.....	130
G4SM Four-Sided Glass Refrigerators.....	130
GDM® Floral Cases.....	132
G4SM Four-Sided Glass Floral Cases	132
GDM® Glass Door Wine Merchandiser	134
GDM® with Health Safety Timers.....	136
TVM® Visual Merchandiser Refrigerators ..	138
FLM™ Full Length Merchandiser	140
TOAM™ Open Air Merchandisers & TOAM™ with Glass Sides	144
TAC® Vertical Air Curtains & TAC® with Glass Sides.....	146
THAC™ Horizontal Air Curtains	146



Retail Merchandisers 148

Medium Temperature150
Low Temperature.....152
Ice Storage.....154



Display Merchandisers 156

TDM™-R Front-Access Refrigerated Display Merchandisers158
TDM™-DZ Front-Access Dual Zone Display Merchandisers160
TDM™-DC Front-Access Dry Display Merchandisers162
TGM™-R Fixed Glass Refrigerated Display Merchandisers164
TGM™-DZ Fixed Glass Dual Zone Display Merchandisers166
TGM™-DC Fixed Glass Dry Display Merchandisers168
TCGG™ Refrigerated Deli Cases.....170



Milk Coolers 172

Single-Sided Milk Coolers174
Dual-Sided Milk Coolers.....174



Heated Cabinets 176

TH Series Heated Cabinets178
STR/STA/STG Heated Cabinets.....180
STR/STA/STG Pass-Thru Heated Cabinets 180
STR/STA/STG Roll-In Heated Cabinets182
STR/STA/STG Roll-Thru Heated Cabinets..182



Bar Refrigeration 184

TBR™ Reach-In, Black Exterior186
TBR™ Pass-Thru, Black Exterior186
TBR™ Reach-In, Stainless Exterior188
TBR™ Pass-Thru, Stainless Exterior188
TBB® Reach-In, Black & Stainless Exterior...190
TBB® Pass-Thru, Black & Stainless Exterior...190
TBB®24 24" (610mm) Reach-In, Black & Stainless Exterior192
TDR™ Reach-In, Black Exterior.....194
TDR™ Pass-Thru, Black Exterior.....194
TDR™ Reach-In, Stainless Exterior.....196
TDR™ Pass-Thru, Stainless Exterior196
TDD™ Beer Dispensers, Black & Stainless Exterior198
TD™ Horizontal Bottle Coolers - Deep Well200
T-GC™ Glass & Plate Chillers/Frosters200
Can/Bottle/Barrel Capacities.....202
Keg Capacities.....204
TBR™/TDR™ Panel Ready Doors.....208



Commercial Ice Machine 210

Modular Cubed Ice Machine.....212
Modular Ice Storage Bins214

Table of Contents



Accessories **216**

Original Equipment Manufacturing Parts.....	218
Spec Series® Options.....	219
Shelving.....	222
Racks & Baskets.....	224
Flat Lids Options.....	225
Plexiglass Lid Options.....	225
Food & Pizza Prep Options.....	226
Shelf Kits.....	226
Castors, Legs & Stacking Collar.....	228
Cutting Boards.....	230
Controls & Displays.....	232
TRM® Accessories.....	232
Open Air & Air Curtain Accessories.....	233
Draft Options.....	234
Premier Bar.....	235
Commercial Ice.....	237
TDM™/TGM™ Options.....	238
Locks.....	240
Additional Accessories.....	241



Customization & Graphics Options **242**

Customization.....	242
Graphics Capabilities.....	244



REACH-IN REFRIGERATION





T-SERIES[®]

BOTTOM MOUNT

The number one selling Reach-in cabinet, chosen by more restaurant owners than any other upright refrigerator. High-end refrigeration meets functionality with True's Reach-in refrigerators. These cabinets have a front-of-house look along with rugged construction for longevity in the busiest kitchens.





SPEC SERIES®

TOP MOUNT

With highly customizable interior and exterior options, Spec Series® are designed to meet the demands of the institutional and consultant market places such as high volume kitchens, schools and hotels.

SPEC SERIES® NOMENCLATURE

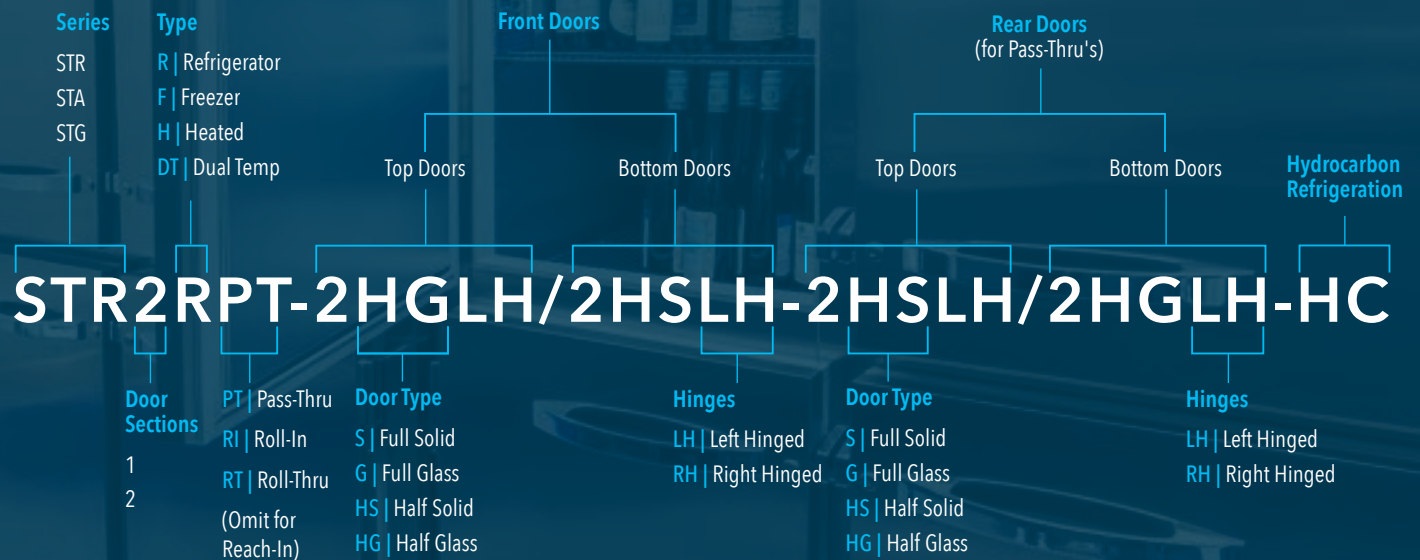

NOTE: Standard hinging is as follows:
STR/STA/STG1 - Right Hinged (RH)
STR/STA/STG2 - Left/Right Hinged (LH)



Bottom Mount Reach-Ins | T-Series® Refrigerators

REACH-IN & PASS-THRU REFRIGERATORS

Solid & Glass, Full & Half Door

Door locks standard

Entire cabinet structure and solid door are foamed-in-place using a high density, polyurethane insulation that has zero ozone depletion potential (ODP) and zero global warming potential (GWP)

Lifetime guaranteed door handles

Digital control for state-of-the-art temperature precision. Environmentally friendly R290 hydrocarbon refrigeration system for the best in food preservation. Refrigerators hold 33° to 38°F

natural refrigerant.

Bottom mount compressor unit performs better in kitchens with higher ambient temperatures and high grease areas

T-49-HC



T-23PT-HC



T-19G-HC-FGD01



T-49-4-HC



T-72-HC

Features/Benefits

- Maintains cold 33°F to 38°F (0.5°C to 3.3°C) product temperatures.
- Exterior - Stainless steel front. Anodized quality aluminum ends. Corrosion resistant GalFan coated steel back.
- Interior - attractive, clear aluminum with stainless steel floor.
- Positive seal self-closing doors with factory tested (over 1,000,000 times) lifetime guaranteed door hinges and torsion type closure system.
- Energy efficient, "Low-E", thermal insulated glass doors.
- Adjustable, heavy-duty, PVC-coated wire shelves.
- 4" (102mm) diameter castors standard (leg levelers standard for T-12-HC & T-12GHC~FGD01; 2.5" (64mm) diameter castors standard equipment for T-19-HC & T-19GHC~FGD01).
- Door locks standard (available on T-12-HC & T-12G-HC~FGD01).
- Exterior digital temperature display (not available on T-12-HC & T-12G-HC~FGD01).
- Legs available for most models.
- LED interior lighting. Safety shielded.
- Lifetime guaranteed recessed door handles on solid door models.
- Alternative hinge orientation available on most T-23/49/72 models. Contact factory for specifics.



T-SERIES® TRADITIONAL REACH-IN REFRIGERATORS

Model	# of Doors	# of Shelves	HP	Amps	Crated Weight lb. (kg.)	Cabinet Dimensions W D† H* (in)	Cabinet Dimensions W D† H* (mm)
SOLID DOORS							
T-11-HC	1	3	1/10	1.6	190 (87)	19 1/4 x 21 1/4 x 70 3/8	487 x 539 x 1786
T-12-HC	1	3	1/6	2.5	185 (84)	24 7/8 x 23 3/8 x 63 3/8	632 x 588 x 1604
T-19-HC	1	3	1/10	1.5	245 (112)	27 x 24 1/2 x 75 1/4	686 x 623 x 1912
T-23-HC	1	3	1/4	2.2	270 (123)	27 x 29 1/2 x 78 3/8	686 x 750 x 1991
T-35-HC	2	6	1/3	5.6	365 (166)	39 1/2 x 29 1/2 x 78 3/8	1004 x 750 x 1991
T-43-HC	2	6	1/2	5.4	370 (168)	47 x 29 1/2 x 78 3/8	1194 x 750 x 1991
T-49-HC	2	6	1/2	5.4	450 (205)	54 1/8 x 29 1/2 x 78 3/8	1375 x 750 x 1991
T-72-HC	3	9	3/4	6.9	575 (261)	78 1/8 x 29 1/2 x 78 3/8	1985 x 750 x 1991
GLASS DOORS							
T-11G-HC~TSL01	1	3	1/10	1.6	220 (100)	19 1/4 x 21 3/8 x 70 3/8	487 x 541 x 1786
T-11G-HC~FGD01	1	3	1/10	1.6	220 (100)	19 1/4 x 21 1/4 x 70 3/8	487 x 539 x 1786
T-12G-HC~FGD01	1	3	1/6	1.8	220 (100)	24 7/8 x 23 3/4 x 63	632 x 591 x 1600
T-19G-HC~FGD01	1	3	1/4	2.2	265 (121)	27 x 24 1/2 x 75 1/4	686 x 623 x 1918
T-23G-HC~FGD01	1	3	1/4	2.2	315 (143)	27 x 29 7/8 x 78 3/8	686 x 759 x 1991
T-35G-HC~FGD01	2	6	1/3	5.6	415 (189)	39 5/8 x 29 7/8 x 78 3/8	1007 x 759 x 1991
T-49G-HC~FGD01	2	6	1/2	5.4	465 (211)	54 1/4 x 29 7/8 x 78 3/8	1378 x 759 x 1991
T-72G-HC~FGD01	3	9	3/4	6.9	630 (286)	78 1/8 x 29 7/8 x 78 3/8	1985 x 759 x 1991
SOLID HALF DOORS							
T-23-2-HC	2	3	1/4	2.2	275 (125)	27 x 29 1/2 x 78 3/8	686 x 750 x 1991
T-49-4-HC	4	6	1/2	5.4	450 (205)	54 1/8 x 29 1/2 x 78 3/8	1375 x 750 x 1991
GLASS HALF DOORS							
T-23G-2-HC~FGD01	2	3	1/4	2.2	331 (151)	27 x 29 3/4 x 78 3/8	686 x 754 x 1991
T-49G-4-HC~FGD01	4	6	1/2	5.4	515 (234)	54 1/8 x 29 3/4 x 78 3/8	1375 x 756 x 1991
COMBINATION HALF DOORS							
T-23-1-G-1-HC~FGD01	2	3	1/4	2.2	311 (142)	27 x 29 3/4 x 78 3/8	686 x 754 x 1991
T-49-2-G-2-HC~FGD01	4	6	1/2	5.4	513 (233)	54 1/8 x 29 3/4 x 78 3/8	1375 x 756 x 1991

† Depth does not include 1 5/8" (42 mm) for glass door handles or 1/2" (13 mm) for system mechanical components.

* Height does not include 5" (127mm) for castors or 6" (153mm) for optional legs 3 1/4" (83mm) castor height for T-19-HC & T-19G-HC~FGD01.

* Height on T-12-HC & T-12G-HC~FGD01 does not include 1" (26mm) for upper door hinge.

note: T-12-HC & T-12G-HC~FGD01 standard with leg levelers, optional 2 1/2" (64mm) diameter castors and 6" (153mm) seismic legs available, 6" (153mm) legs not available.

T-SERIES® PASS-THRU

Model	# of Doors	# of Shelves	HP	Amps	Crated Weight lb. (kg.)	Cabinet Dimensions W D H* (in)	Cabinet Dimensions W D H* (mm)
PASS-THRU SOLID FRONT DOORS/SOLID REAR DOORS							
T-23PT-HC	1 fr / 1bk	3	1/4	2.2	325 (148)	27 x 32 1/8 x 78 3/8	686 x 816 x 1991

* Height does not include 5" (127mm) for castors or 6" (153mm) for optional legs.

Bottom Mount Reach-Ins | TSD Series Refrigerators

SLIDE DOOR REFRIGERATORS

Solid & Glass Slide Door



TSD-09G-HC-LD



TSD-33-HC



TSD-47G-HC-LD



TSD-69-HC

Features/Benefits

- Factory balanced, environmentally-friendly R290 Hydrocarbon forced-air refrigeration system.
- Maintains cold 33°F to 38°F (0.5°C to 3.3°C) product temperatures.
- Exterior - Stainless steel front. Anodized quality aluminum ends. Corrosion resistant GalFan coated steel back.
- Interior - attractive, clear aluminum liner. Stainless steel floor with coved corners.
- Energy efficient, "Low-E", thermal insulated glass doors.
- Adjustable, heavy-duty, PVC-coated wire shelves.
- Legs standard on slide door models (except for TSD-09G-HC-LD which uses leg levelers).
- LED interior lighting. Safety shielded.
- Compressor performs in the coolest, most grease-free area of kitchen for ease of compressor load.
- Compressor can be serviced easily, and accessed by a single repairman.

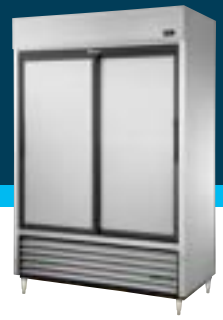

TSD SERIES SLIDE DOOR REFRIGERATORS

Model	# of Doors	# of Shelves	HP	Amps	Crated Weight lb. (kg.)	Cabinet Dimensions W D† H* (in)	Cabinet Dimensions W D† H* (mm)
SOLID DOORS							
TSD-33-HC	2	6	½	6.5	350 (159)	39½ x 29¾ x 78¾	1004 x 753 x 1991
TSD-47-HC	2	6	½	8.5	410 (186)	54½ x 29¾ x 78¾	1375 x 753 x 1991
TSD-69-HC	3	9	½	7.1	630 (286)	78½ x 29¾ x 78¾	1985 x 753 x 1991
GLASS DOORS							
TSD-09G-HC-LD	2	3	¼	1.9	280 (127)	36 x 21 x 35¾	913 x 532 x 911
TSD-33G-HC-LD	2	6	½	6.5	370 (168)	39½ x 29¾ x 78¾	1004 x 753 x 1991
TSD-47G-HC-LD	2	6	½	8.5	440 (200)	54½ x 29¾ x 78¾	1375 x 753 x 1991
TSD-69G-HC-LD	3	9	½	7.1	630 (286)	78½ x 29¾ x 78¾	1985 x 753 x 1991

† Depth does not include ¾" (10 mm) for door handles (solid or glass), ⅞" (23 mm) for door handle on TSD-09G-HC-LD.

* Height does not include 6 ⅛" (156mm) for legs or 5" (127mm) for optional castors. (TSD-09G-HC-LD standard with leg levelers).

Bottom Mount Reach-Ins | TS Series Refrigerators

STAINLESS STEEL REFRIGERATORS

Solid & Glass, Full & Half Door



TS-35-HC



TS-23G-HC-FGD01



TS-23-2-HC



TS-49-HC



TS-72G-HC-FGD01

Features/Benefits

- True's "TS" series is the choice for the exclusive stainless steel commercial application. Designed with enduring quality that protects your long-term investment, and oversized refrigeration that guarantees exceptional food preservation.
- Factory balanced, environmentally-friendly R290 Hydrocarbon forced-air refrigeration system.
- Maintains 33°F to 38°F (0.5°C to 3.3°C) product temperatures.
- Energy efficient, thermal insulated glass doors.
- Energy efficient, thermal insulated glass doors.
- Adjustable, heavy-duty, PVC-coated wire shelves.
- LED interior lighting. Safety shielded.
- Alternative hinge orientation available on most TS-23/49/72 models. Contact factory for specifics.
- A "no-stoop", lower shelf.
- Compressor performs in the coolest, most grease-free area of kitchen for ease of compressor load.
- Compressor can be serviced easily, and accessed by a single repairman.



TS SERIES REACH-IN REFRIGERATORS

Model	# of Doors	# of Shelves	HP	Amps	Crated Weight lb. (kg.)	Cabinet Dimensions W D† H* (in)	Cabinet Dimensions W D† H* (mm)
SOLID DOORS							
TS-23-HC	1	3	¼	2.2	285 (130)	27 x 29½ x 78¾	686 x 750 x 1991
TS-35-HC	2	6	⅓	5.6	350 (159)	39½ x 29½ x 78¾	1004 x 750 x 1991
TS-43-HC	2	6	½	5.4	380 (173)	47 x 29½ x 78¾	1194 x 750 x 1991
TS-49-HC	2	6	½	5.4	400 (182)	54½ x 29½ x 78¾	1375 x 750 x 1991
TS-72-HC	3	9	¾	6.9	615 (280)	78½ x 29½ x 78¾	1985 x 750 x 1991
GLASS DOORS							
TS-23G-HC~FGD01	1	3	¼	2.2	315 (143)	27 x 29¾ x 78¾	686 x 756 x 1991
TS-49G-HC~FGD01	2	6	½	5.4	533 (242)	54¼ x 29¾ x 78¾	1378 x 759 x 1991
TS-72G-HC~FGD01	3	9	¾	6.9	691 (314)	78½ x 29¾ x 78¾	1378 x 759 x 1991
SOLID HALF DOORS							
TS-23-2-HC	2	3	¼	2.2	320 (146)	27 x 29½ x 78¾	686 x 750 x 1991
TS-49-4-HC	4	6	½	5.4	400 (182)	54½ x 29½ x 78¾	1375 x 750 x 1991
GLASS HALF DOORS							
TS-23G-2-HC~FGD01	2	3	¼	2.2	330 (150)	27 x 29¾ x 78¾	686 x 756 x 1991
TS-49G-4-HC~FGD01	4	6	½	5.4	515 (232)	54½ x 29¾ x 78¾	1375 x 756 x 1991
COMBINATION HALF DOORS							
TS-23-1-G-1-HC~FGD01	2	3	¼	2.2	330 (150)	27 x 29¾ x 78¾	686 x 756 x 1991
TS-49-2-G-2-HC~FGD01	4	6	½	5.4	515 (233)	54½ x 29¾ x 78¾	1375 x 756 x 1991

† Depth does not include 1⅝" (42 mm) for door handles (glass door models only).

* Height does not include 5" (127mm) for castors or 6" (153mm) for optional legs.

Bottom Mount Reach-Ins | TGN® Refrigerators

REACH-IN GASTRONORM REFRIGERATORS

Solid & Glass Doors



Dual tray slide system with wire shelves (accommodates two (2) 12" (305mm) x 20" (508mm) food storage pans)



4" (102mm) diameter castors standard. Optional legs available



TGN-2R-2S



TGN-1R-1G



TGN-1R-1S



TGN-2R-2G

Features/Benefits

- Factory balanced, environmentally-friendly R290 Hydrocarbon forced-air refrigeration system.
- Maintains 32°F to 41°F (0°C to 5°C) temperatures.
- Energy efficient, thermal insulated glass doors.
- Barrel door locks
- Exterior - Stainless steel front. Aluminum ends and GalFan back and top.
- Interior - Clear coated aluminum, stainless steel floor.
- Exterior temperature display.
- Field reversible door hinging.
- Energy efficient, thermal insulated glass doors.
- LED interior lighting.
- A "no-stoop", lower shelf.
- Compressor performs in the coolest, most grease-free area of kitchen for ease of compressor load.
- Compressor can be serviced easily, and accessed by a single repairman.



TGN® REACH-IN REFRIGERATORS

Model	# of Doors	# of Shelves	HP	Amps	Crated Weight lb. (kg.)	Cabinet Dimensions W D† H* (in)	Cabinet Dimensions W D† H* (mm)
SOLID DOORS							
TGN-1R-1S	1	3	¼	2.2	285 (130)	27 x 29½ x 78¾	686 x 750 x 1991
TGN-2R-2S	2	6	¼	2.9	520 (236)	57¾ x 33¾ x 78½	1464 x 861 x 1994
GLASS DOORS							
TGN-1R-1G	1	3	¼	2.2	315 (143)	27 x 29¾ x 78¾	686 x 756 x 1991
TGN-2R-2G	2	6	¼	2.9	520 (236)	57¾ x 33¾ x 78½	1464 x 861 x 1994

† Depth does not include 1¾" (44 mm) for door handles or ½" (13 mm) for rear mechanical components.

* Height does not include 5" (127mm) for castors.

TGN® TRAY SLIDE SYSTEMS



Standard Tray Slide

will allow a food storage pan to be placed under the shelf



Universal Tray Slides

16 ga. stainless steel
Angle type for bottom support of:
(1) 18" x 26" pan or
(2) 14" x 18" pans or
(2) 12" x 20" pans



Angle Tray Slides

16 ga. stainless steel
Angle type for bottom support of:
(1) 18" x 26" pan or
(2) 14" x 18" pans

Note: Up to two (2) options can be used in unit.

Top Mount Reach-Ins | SPEC SERIES® Refrigerators

STR/STA/STG REFRIGERATORS

Solid & Glass, Full & Half Door

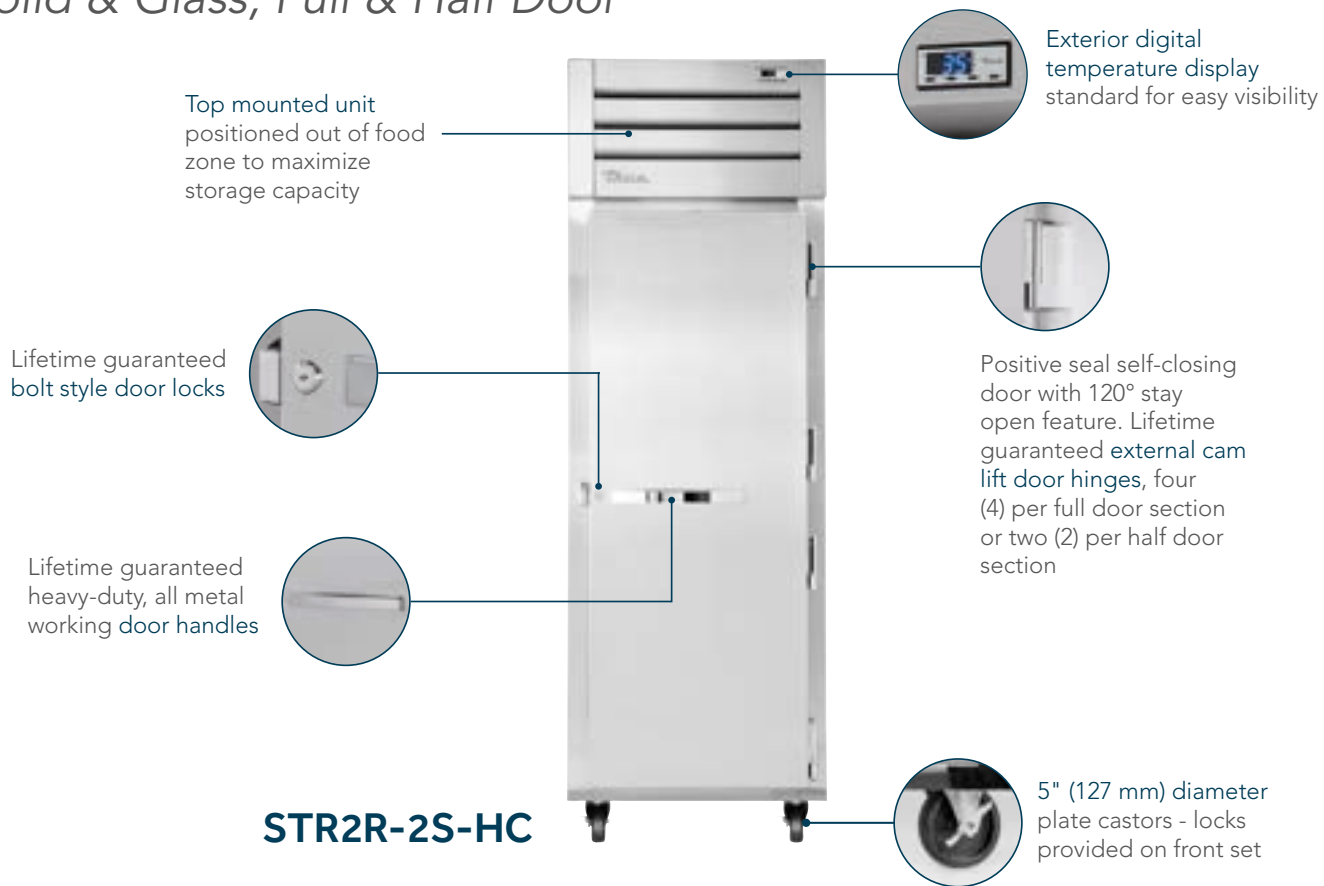

STA1R-1HG/1HS-HC



STR1R-2HS-HC



STR2R-2G-HC



STG2R-4G-HC

Features/Benefits

- Maintains cabinet temperatures of 33°F to 38°F (.5°C to 3.3°C) for the best in food preservation.
- State-of-the-art, electronically commutated evaporator and condenser fan motors. ECM motors operate at higher peak efficiencies, produce less heat and move a more consistent volume of air; all of these reduce energy consumption and provides greater motor reliability.
- Factory balanced, environmentally-friendly R290 Hydrocarbon forced-air refrigeration system.
- Pilasters and tray slides/shelving are factory installed at no charge on STR units. (optional on STA/STG units).
- LED interior lighting, safety shielded.
- Energy efficient, "Low-E", thermal insulated glass doors on glass door models.
- Extruded, aluminum door frames on glass doors.
- STR - Stainless steel interior and exterior.
- STA - Exterior stainless steel. Interior is clear aluminum with stainless steel floor.
- STG - Exterior stainless steel door. Interior clear aluminum sides and back, stainless steel floor.



STR/STA/STG REACH-IN REFRIGERATORS

Model	# of Doors	# of Shelves STA/STG models	HP	Amps	Crated Weight lb. (kg.)	Cabinet Dimensions W D† H* (in)	Cabinet Dimensions W D† H* (mm)
SOLID DOORS							
STR1R-1S-HC	1	3	¼	3.8	430 (196)	27½ x 33¾ x 77¾	699 x 858 x 1975
STR2R-2S-HC	2	6	½	5.9	650 (295)	52½ x 33¾ x 77¾	1337 x 858 x 1975
STR3R-3S-HC	3	9	¾	6.1	770 (350)	77¾ x 33¾ x 77¾	1975 x 858 x 1975
SOLID HALF DOORS							
STR1R-2HS-HC	2	3	¼	3.8	430 (196)	27½ x 33¾ x 77¾	699 x 858 x 1975
STR2R-4HS-HC	4	6	½	5.9	730 (332)	52½ x 33¾ x 77¾	1337 x 858 x 1975
STR3R-6HS-HC	6	9	¾	6.1	880 (400)	77¾ x 33¾ x 77¾	1975 x 858 x 1975
GLASS DOORS							
STR1R-1G-HC	1	3	¼	3.8	480 (218)	27½ x 33¾ x 77¾	699 x 858 x 1975
STR2R-2G-HC	2	6	½	5.9	795 (361)	52½ x 33¾ x 77¾	1337 x 858 x 1975
STR3R-3G-HC	3	9	¾	6.1	867 (394)	77¾ x 33¾ x 77¾	1975 x 858 x 1975
GLASS HALF DOORS							
STR1R-2HG-HC	2	3	¼	3.8	460 (209)	27½ x 33¾ x 77¾	699 x 858 x 1975
STR2R-4HG-HC	4	6	½	5.9	730 (332)	52½ x 33¾ x 77¾	1337 x 858 x 1975
COMBINATION HALF DOORS							
STR1R-1HG/1HS-HC	2	3	¼	3.8	450 (205)	27½ x 33¾ x 77¾	699 x 858 x 1975
STR2R-2HG/2HS-HC	4	6	½	5.9	710 (322)	52½ x 33¾ x 77¾	1337 x 858 x 1975

† Depth does not include 1½" (39 mm) for door handles.

* Height does not include 6⅝" (156mm) for castors or 6" (153mm) for optional legs

* Height does not include ¼" (7mm) for system mechanical components.

note: Crated weight listed on the chart is for STR model, STA & STG versions may have different weights.

VLD VERTICAL LED LIGHTING MODELS

Model
GLASS DOORS
STR1RVLD-1G-HC
STR2RVLD-2G-HC
STR3RVLD-3G
GLASS HALF DOORS
STR1RVLD-2HG-HC
STR2RVLD-4HG-HC

note: Specifications are the same as standard models, just vertical LED Lighting added.

note: Only available on refrigerators.



Series Shelving

STR Series Shelving - (1) interior kit option included per full section at no charge.

(4) different interior kits available.

STA Series Shelving - (3) heavy-duty, chrome-plated wire shelves per section.

(4) different interior kits available.

STG Series Shelving - (3) heavy-duty, PVC-coated wire shelves per section.

(4) different interior kits available.

See "Spec Series accessories" (pg. 211) for additional details.

Top Mount Reach-Ins | SPEC SERIES® Refrigerators

STR/STA/STG PASS-THRU REFRIGERATORS

Solid & Glass, Full & Half Door



STG1RPT-2HG-1S-HC



STA1RPT-2HS-1S-HC



STA2PRT-4G-4HG-HC



STR2RRT-4HS-2S-HC

Features/Benefits

- Maintains cabinet temperatures of 33°F to 38°F (.5°C to 3.3°C) for the best in food preservation.
- State-of-the-art, electronically commutated evaporator and condenser fan motors. ECM motors operate at higher peak efficiencies, produce less heat and move a more consistent volume of air; all of these reduce energy consumption and provides greater motor reliability.
- Factory balanced, environmentally-friendly R290 Hydrocarbon forced-air refrigeration system.
- Pilasters and tray slides/shelving are factory installed at no charge on STR units. (optional on STA/STG units).
- LED interior lighting, safety shielded.
- Energy efficient, "Low-E", thermal insulated glass doors on glass door models.
- Extruded, aluminum door frames on glass doors.
- STR - Stainless steel interior and exterior.
- STA - Exterior stainless steel. Interior is clear aluminum with stainless steel floor.
- STG - Exterior stainless steel door. Interior clear aluminum sides and back, stainless steel floor.



STR/STA/STG PASS-THRU REFRIGERATORS

Model	# of Doors	# of Shelves STA/STG models	HP	Amps	Crated Weight lb. (kg.)	Cabinet Dimensions W D† H*	Cabinet Dimensions W D† H*
SOLID FRONT/SOLID REAR DOORS							
STR1RPT-1S-1S-HC	1 fr / 1 bk	3	¼	3.8	475 (216)	27½x 36½x 77¾	699 x 918 x 1975
STR2RPT-2S-2S-HC	2 fr / 2 bk	6	½	5.9	720 (327)	52½x 36½x 77¾	1337 x 918 x 1975
SOLID FRONT HALF DOORS/SOLID REAR DOORS							
STR1RPT-2HS-1S-HC	2 fr / 1 bk	3	¼	3.8	440 (200)	27½x 36½x 77¾	699 x 918 x 1975
STR2RPT-4HS-2S-HC	4 fr / 2 bk	6	½	5.9	745 (338)	52½x 36½x 77¾	1337 x 918 x 1975
GLASS FRONT/SOLID REAR DOORS							
STR1RPT-1G-1S-HC	1 fr / 1 bk	3	¼	3.8	475 (216)	27½x 36½x 77¾	699 x 918 x 1975
STR2RPT-2G-2S-HC	2 fr / 2 bk	6	½	5.9	720 (327)	52½x 36½x 77¾	1337 x 918 x 1975
GLASS FRONT HALF DOORS/SOLID REAR DOORS							
STR1RPT-2HG-1S-HC	2 fr / 1 bk	3	¼	3.8	520 (236)	27½x 36½x 77¾	699 x 918 x 1975
STR2RPT-4HG-2S-HC	4 fr / 2 bk	6	½	5.9	820 (372)	52½x 36½x 77¾	1337 x 918 x 1975
COMBINATION FRONT HALF DOORS/SOLID REAR DOORS							
STR1RPT-1HG/1HS-1S-HC	2 fr / 1 bk	3	¼	3.8	490 (223)	27½x 36½x 77¾	699 x 918 x 1975
STR2RPT-2HG/2HS-2S-HC	4 fr / 2 bk	6	½	5.9	720 (327)	52½x 36½x 77¾	1337 x 918 x 1975
SOLID FRONT/GLASS REAR DOORS							
STR1RPT-1S-1G-HC	1 fr / 1 bk	3	¼	3.8	475 (216)	27½x 36½x 77¾	699 x 918 x 1975
STR2RPT-2S-2G-HC	2 fr / 2 bk	6	½	5.9	720 (327)	52½x 36½x 77¾	1337 x 918 x 1975
SOLID FRONT HALF DOORS/GLASS REAR DOORS							
STR1RPT-2HS-1G-HC	2 fr / 1 bk	3	¼	3.8	440 (200)	27½x 36½x 77¾	699 x 918 x 1975
STR2RPT-4HS-2G-HC	4 fr / 2 bk	6	½	5.9	745 (338)	52½x 36½x 77¾	1337 x 918 x 1975
GLASS FRONT/GLASS REAR DOORS							
STR1RPT-1G-1G-HC	1 fr / 1 bk	3	¼	3.8	440 (200)	27½x 36½x 77¾	699 x 918 x 1975
STR2RPT-2G-2G-HC	2 fr / 2 bk	6	½	5.9	720 (327)	52½x 36½x 77¾	1337 x 918 x 1975
COMBINATION FRONT HALF DOORS/GLASS REAR DOORS							
STR1RPT-1HG/1HS-1G-HC	2 fr / 1 bk	3	¼	3.8	475 (216)	27½x 36½x 77¾	699 x 918 x 1975
STR2RPT-2HG/2HS-2S-HC	4 fr / 2 bk	6	½	5.9	775 (352)	52½x 36½x 77¾	1337 x 918 x 1975
GLASS FRONT HALF DOORS/GLASS REAR DOORS							
STR1RPT-2HG-1G-HC	2 fr / 1 bk	3	¼	3.8	440 (200)	27½x 36½x 77¾	699 x 918 x 1975
STR2RPT-4HG-2G-HC	4 fr / 2 bk	6	½	5.9	820 (372)	52½x 36½x 77¾	1337 x 918 x 1975

† Depth does not include 1½" (39 mm) for door handles.

* Height does not include 6½" (156mm) for castors or 6" (153mm) for optional legs

* Height does not include ¼" (7mm) for system mechanical components.

note: Crated weight listed on the chart is for STR model, STA & STG versions may have different weights.

VLD VERTICAL LED LIGHTING MODELS

Model
GLASS DOORS
STR1RPTVLD-1G-HC
STR2RPTVLD-2G-HC
GLASS HALF DOORS
STR1RPTVLD-2HG-HC
STR2RPTVLD-4HG-HC

note: Specifications are the same as standard models, just vertical LED Lighting added.

note: Only available on refrigerators.



Series Shelving

STR Series Shelving - (1) interior kit option included per full section at no charge.

(4) different interior kits available.

STA Series Shelving - (3) heavy-duty, chrome-plated wire shelves per section.

(4) different interior kits available.

STG Series Shelving - (3) heavy-duty, PVC-coated wire shelves per section.

(4) different interior kits available.

See "Spec Series accessories" (pg. 211) for additional details.

Top Mount Reach-Ins | SPEC SERIES® Refrigerators

STR/STA/STG ROLL-IN & ROLL-THRU REFRIGERATORS

Solid & Glass, Full Doors



STR1RRI-1S



STR2RRI-2S



STG2RRT-2G-2S



STR2RRI89-1S

Features/Benefits

- Maintains cabinet temperatures of 33°F to 38°F (.5°C to 3.3°C) for the best in food preservation.
- Accepts roll-in rack (inboard castor) with maximum dimensions of 27"W x 29"D x 66"H (686mm x 737mm x 1677mm). STR/STA/STG1RRI89-1S and STR/STA/STG2RRI89-2S accept roll-in rack (inboard castor) with maximum dimensions of 27"W x 29"D x 72"H (686mm x 737mm x 1,829mm) (supplied by others).
- Factory engineered, self-contained, refrigeration system with capillary tube using environmentally-friendly (CFC free) 134A refrigerant.
- State-of-the-art, electronically commutated evaporator and condenser fan motors. ECM motors operate at higher peak efficiencies, produce less heat and move a more consistent volume of air; all of these reduce energy consumption and provides greater motor reliability.
- Incandescent interior lighting.
- Energy efficient, "Low-E", thermal insulated glass doors on glass door models.
- Extruded, aluminum door frames on glass doors.
- Self-contained system.
- STR - Stainless steel interior and exterior.
- STA - Exterior stainless steel. Interior is clear aluminum with stainless steel floor.
- STG - Exterior stainless steel door. Interior clear aluminum sides and back, stainless steel floor.



STR/STA/STG ROLL-IN REFRIGERATORS

Model	# of Doors	HP	Amps	Crated Weight lb. (kg.)	Cabinet Dimensions W D† H* (in)	Cabinet Dimensions W D† H* (mm)
SOLID DOORS						
STR1RRI-1S	1	1/3	8.9	470 (214)	35 x 34 3/4 x 83 3/4	889 x 883 x 2128
STR2RRI-2S	2	1/2	11.8	770 (350)	68 x 34 3/4 x 83 3/4	1728 x 883 x 2128
GLASS DOORS						
STR1RRI-1G	1	1/3	8.9	455 (207)	35 x 34 3/4 x 83 3/4	889 x 883 x 2128
STR2RRI-2G	2	1/2	11.8	760 (345)	68 x 34 3/4 x 83 3/4	1728 x 883 x 2128
SOLID DOOR 89" HIGH						
STR1RRI89-1S	1	1/3	8.9	450 (205)	35 x 34 3/4 x 88 3/4	889 x 883 x 2255
STR2RRI89-2S	2	1/2	11.8	805 (366)	68 x 34 3/4 x 88 3/4	1728 x 883 x 2255

† Depth does not include 4 1/4" (108 mm) for ramp.

* Height does not include 1/4" (7mm) for system mechanical components.

note: Crated weight listed on the chart is for STR model, STA & STG versions may have different weights.

STR/STA/STG ROLL-THRU REFRIGERATORS

Model	# of Doors	HP	Amps	Crated Weight lb. (kg.)	Cabinet Dimensions W D† H* (in)	Cabinet Dimensions W D† H* (mm)
SOLID DOORS						
STR1RRT-1S-1S	1 fr / 1 bk	1/3	8.9	540 (245)	35 x 37 1/2 x 83 3/4	889 x 953 x 2128
STR2RRT-2S-2S	2fr / 2bk	1/2	9.5	870 (395)	68 x 37 1/2 x 83 3/4	1728 x 953 x 2128
GLASS FRONT/SOLID REAR DOOR						
STR1RRT-1G-1S	1 fr / 1 bk	1/3	8.9	540 (245)	35 x 37 1/2 x 83 3/4	889 x 953 x 2128
STR2RRT-2G-2S	2fr / 2bk	1/2	9.5	710 (323)	68 x 37 1/2 x 83 3/4	1728 x 953 x 2128
SOLID DOOR 89" HIGH						
STR1RRT89-1S-1S	1 fr / 1 bk	1/3	8.9	540 (245)	35 x 37 1/2 x 88 3/4	889 x 953 x 2255
STR2RRT89-2S-2S	2fr / 2bk	1/2	9.5	760 (345)	68 x 37 1/2 x 88 3/4	1728 x 953 x 2255

† Depth does not include 4 1/4" (108 mm) for ramp.

* Height does not include 1/4" (7mm) for system mechanical components.

note: Crated weight listed on the chart is for STR model, STA & STG versions may have different weights.

Bottom Mount Reach-Ins | T-Series® Freezers

REACH-IN FREEZERS

Solid & Glass, Full & Half Door



T-23F-HC



T-12F-HC~FGD01



T-19FZ-HC



T-49F-4-HC



T-72F-HC

Features/Benefits

- -10°F (-23.3°C) product temperature (air off evaporator coil, -20°F (-28.9°C) holds frozen food and ice cream (T-19FZ-HC maintains 0°F (-18°C)).
 - Exterior - Stainless steel front. Anodized quality aluminum ends. Corrosion resistant GalFan coated steel back.
 - Interior - attractive, clear aluminum with stainless steel floor.
 - Large evaporator and coil heater permit short defrost cycles.
 - Automatic defrost system.
 - Energy efficient, triple pane, thermal insulated glass doors.
 - 4" (102mm) diameter castors standard (leg levelers standard for T-12-HC & T-12FG-HC~FGD01; 2.5" (64mm) diameter castors standard equipment for T-19F-HC & T-19FG-HC~FGD01).
 - Door hinges and torsion type closure system.
 - 6" (153mm) Legs available for most models (6" (153mm) seismic legs only available on T-12F-HC & T-12FG-HC~FGD01).
 - LED interior lighting. Safety shielded.
 - Recessed door handles on solid door models.
 - Alternative hinge orientation available on most T-23F/49F/72F models. Contact factory for specifics.
- FLX models...**
- Easily converts from freezer to refrigerator with the flip of a switch.



T-SERIES® TRADITIONAL REACH-IN FREEZERS

Model	# of Doors	# of Shelves	HP	Amps	Crated Weight lb. (kg.)	Cabinet Dimensions W D† H* (in)	Cabinet Dimensions W D† H* (mm)
SOLID DOORS							
T-12F-HC	1	3	½	4.5	170 (78)	24⅞ x 23⅞ x 63⅞	632 x 588 x 1604
T-19F-HC	1	3	½	3.7	265 (120)	27 x 24½ x 75¼	686 x 623 x 1912
T-23F-HC	1	3	½	3.7	295 (134)	27 x 29½ x 78¾	686 x 750 x 1991
T-35F-HC	2	6	1	9.6	390 (177)	39½ x 29½ x 78¾	1004 x 750 x 1991
T-43F-HC	2	6	1	9.6	410 (186)	47 x 29½ x 78¾	1194 x 750 x 1991
T-49F-HC	2	6	1	9.6	480 (218)	54⅞ x 29½ x 78¾	1375 x 750 x 1991
T-72F-HC	3	9	¾	14.0	650 (295)	78⅞ x 29½ x 78¾	1985 x 750 x 1991
0° SOLID DOOR FREEZER							
T-19FZ-HC	1	3	½	3.7	270 (123)	27 x 24½ x 75¼	686 x 623 x 1912
GLASS DOORS							
T-12FG-HC~FGD01	1	3	½	4.5	255 (116)	24⅞ x 23¼ x 63	632 x 591 x 1600
T-23FG-HC~FGD01	1	3	¾	6.2	330 (150)	27 x 29⅞ x 78¾	686 x 759 x 1991
T-49FG-HC~FGD01	2	6	(2) ½	9.5	605 (275)	54⅞ x 29¾ x 78¾	1375 x 756 x 1991
T-72FG-HC~FGD01	3	9	¾	13.0	805 (366)	78⅞ x 29¾ x 78¾	1985 x 756 x 1991
SOLID HALF DOORS							
T-23F-2-HC	2	3	½	3.7	300 (137)	27 x 29½ x 78¾	686 x 750 x 1991
T-49F-4-HC	4	6	1	9.6	480 (218)	54⅞ x 29½ x 78¾	1375 x 750 x 1991

† Depth does not include 1⅝" (42 mm) for glass door handles or ½" (13 mm) for system mechanical components.

* Height does not include 5" (127mm) for castors or 6" (153mm) for optional legs (3¼" (83mm) castor height for T-19F-HC).

* Height on T-12F-HC & T-12FG-HC~FGD01 does not include 1" (26mm) for upper door hinge.

note: T-12F-HC & T-12FG-HC~FGD01 standard with leg levelers, optional 2½" (64mm) diameter castors and 6" (153mm) seismic legs available, 6" (153mm) legs not available.

FLX REACH-IN CONVERTIBLE REFRIGERATOR/FREEZER

Model	# of Doors	# of Shelves	HP	Amps	Crated Weight lb. (kg.)	Cabinet Dimensions W D† H* (in)	Cabinet Dimensions W D† H* (mm)
SOLID DOORS							
T-19F-FLX-HC	1	3	½	3.7	255 (116)	27 x 24½ x 75¼	686 x 623 x 1912
T-23F-FLX-HC	1	3	½	3.7	295 (134)	27 x 29½ x 78¾	686 x 750 x 1991
T-35F-FLX-HC	2	6	¾	6.0	390 (176)	39½ x 29½ x 78¾	1004x750x1991
T-49F-FLX-HC	2	6	1	9.6	480 (218)	54⅞ x 29½ x 78¾	1375 x 750 x 1991
GLASS DOORS							
T-23FG-FLX-HC~FGD01	1	3	½	6.2	330 (150)	27 x 29⅞ x 78¾	686 x 756 x 1991
T-49FG-FLX-HC~FGD01	2	6	(2) ½	9.5	650 (295)	54⅞ x 29¾ x 78¾	1375 x 756 x 1991

† Depth does not include 1⅝" (35 mm) for door handles or ½" (13 mm) for system mechanical components.

* Height does not include 5" (127mm) for castors or 6" (153mm) for optional legs (3¼" (83mm) castor height for T-19F-FLX-HC).



Bottom Mount Reach-Ins | TS Series Freezers

STAINLESS STEEL FREEZERS

Solid & Glass, Full & Half Door



TS-49F-HC



TS-23F-HC



TS-23F-2-HC



TS-49FG-HC-FGD01



TS-72FG-HC-FGD01

Features/Benefits

- True's "TS" series is the choice for the exclusive stainless steel commercial application. Designed with enduring quality that protects your long-term investment, and oversized refrigeration that guarantees exceptional food preservation.
 - Factory balanced, environmentally-friendly R290 Hydrocarbon forced-air refrigeration system.
 - Maintains -10°F (-23.3°C) product temperatures.
 - Large evaporator and coil heater permit short defrost cycle on freezers.
 - Automatic defrost system.
 - Energy efficient, triple pane, thermal insulated glass doors.
 - Adjustable, heavy-duty, PVC-coated wire shelves.
 - LED interior lighting. Safety shielded.
 - Alternative hinge orientation available on most TS-23/49/72 models. Contact factory for specifics.
 - A "no-stoop", lower shelf.
 - Compressor performs in the coolest, most grease-free area of kitchen for ease of compressor load.
 - Compressor can be serviced easily, and accessed by a single repairman.
- FLX models...**
- Easily converts from freezer to refrigerator with the flip of a switch.



TS SERIES REACH-IN FREEZERS

Model	# of Doors	# of Shelves	HP	Amps	Crated Weight lb. (kg.)	Cabinet Dimensions W D† H* (in)	Cabinet Dimensions W D† H* (mm)
SOLID DOORS							
TS-23F-HC	1	3	½	3.7	310 (141)	27 x 29½ x 78¾	686 x 750 x 1991
TS-35F-HC	2	6	1	9.6	455 (207)	39½ x 29½ x 78¾	1004 x 750 x 1991
TS-43F-HC	2	6	1	9.6	410 (186)	47 x 29½ x 78¾	1194 x 750 x 1991
TS-49F-HC	2	6	1	9.6	515 (234)	54½ x 29½ x 78¾	1375 x 750 x 1991
TS-72F-HC	3	9	¾	14.0	650 (295)	78½ x 29½ x 78¾	1985 x 750 x 1991
GLASS DOORS							
TS-23FG-HC~FGD01	1	3	¾	6.2	330 (150)	27 x 29¾ x 78¾	686 x 759 x 1991
TS-49FG-HC~FGD01	2	6	½	11.0	605 (275)	54½ x 29¾ x 78¾	1375 x 756 x 1991
TS-72FG-HC~FGD01	3	9	¾	13.0	760 (345)	78½ x 29¾ x 78¾	1985 x 756 x 1991
SOLID HALF DOORS							
TS-23F-2-HC	2	3	½	3.7	330 (150)	27 x 29½ x 78¾	686 x 750 x 1991
TS-49F-4-HC	4	6	1	9.6	440 (200)	54½ x 29½ x 78¾	1375 x 750 x 1991

† Depth does not include 1¾" (35 mm) for door handles (glass door models only).

* Height does not include 5" (127mm) for castors or 6" (153mm) for optional legs.

note: TS-49F-HC, TS-72F-HC, TS-49FG-HC~FGD01, TS-72FG-HC~FGD01 completely pre-wired at factory and ready for final connection to a 115/60/1 phase, 20 amp dedicated outlet.

TS SERIES FLX REACH-IN CONVERTIBLE REFRIGERATOR/FREEZER

Model	# of Doors	# of Shelves	HP	Amps	Crated Weight lb. (kg.)	Cabinet Dimensions W D† H* (in)	Cabinet Dimensions W D† H* (mm)
SOLID DOORS							
TS-23F-FLX-HC	1	3	½	3.7	315 (143)	27 x 29½ x 78¾	686 x 750 x 1991
TS-35F-FLX-HC	2	6	¾	6.0	455 (207)	39½ x 29½ x 78¾	1004x750x1991

† Depth does not include 1¾" (35 mm) for door handles or ½" (13 mm) for system mechanical components.

* Height does not include 5" (127mm) for castors or 6" (153mm) for optional legs.



REACH-IN GASTRONORM FREEZERS

Solid Doors



Dual tray slide system with wire shelves (accommodates two (2) 12" (305mm) x 20" (508mm) food storage pans)



TGN-2F-2S

4" (102mm) diameter castors standard. Optional legs available



TGN-1F-1S

Features/Benefits

- Factory balanced, environmentally-friendly R290 Hydrocarbon forced-air refrigeration system.
- Maintains -10°F to 5°F (-23.3°C to -15°C) temperatures.
- Energy efficient, thermal insulated glass doors.
- Barrel door locks
- Exterior - Stainless steel front. Aluminum ends and GalFan back and top.
- Interior - Clear coated aluminum, stainless steel floor.
- Exterior temperature display.
- Field reversible door hinging.
- Energy efficient, thermal insulated glass doors.
- LED interior lighting.
- A "no-stoop", lower shelf.
- Compressor performs in the coolest, most grease-free area of kitchen for ease of compressor load.
- Compressor can be serviced easily, and accessed by a single repairman.



TGN® REACH-IN FREEZERS

Model	# of Doors	# of Shelves	HP	Amps	Crated Weight lb. (kg.)	Cabinet Dimensions W D† H* (in)	Cabinet Dimensions W D† H* (mm)
SOLID DOORS							
TGN-1R-1S	1	3	¼	2.2	285 (130)	27 x 29½ x 78¾	686 x 750 x 1991
TGN-2R-2S	2	6	¼	5.9	520 (236)	57¾ x 33¾ x 78½	1464 x 861 x 1994

† Depth does not include 1¾" (44 mm) for door handles or ½" (13 mm) for rear mechanical components.
* Height does not include 5" (127mm) for castors.

TGN® TRAY SLIDE SYSTEMS



Standard Tray Slide

will allow a food storage pan to be placed under the shelf



Universal Tray Slides

16 ga. stainless steel
Angle type for bottom support of:
(1) 18" x 26" pan or
(2) 14" x 18" pans or
(2) 12" x 20" pans



Angle Tray Slides

16 ga. stainless steel
Angle type for bottom support of:
(1) 18" x 26" pan or
(2) 14" x 18" pans

Note: Up to two (2) options can be used in unit.

Top Mount Reach-Ins | SPEC SERIES® Freezers

STR/STA/STG REACH-IN & PASS-THRU FREEZERS

Solid & Glass, Full & Half Door

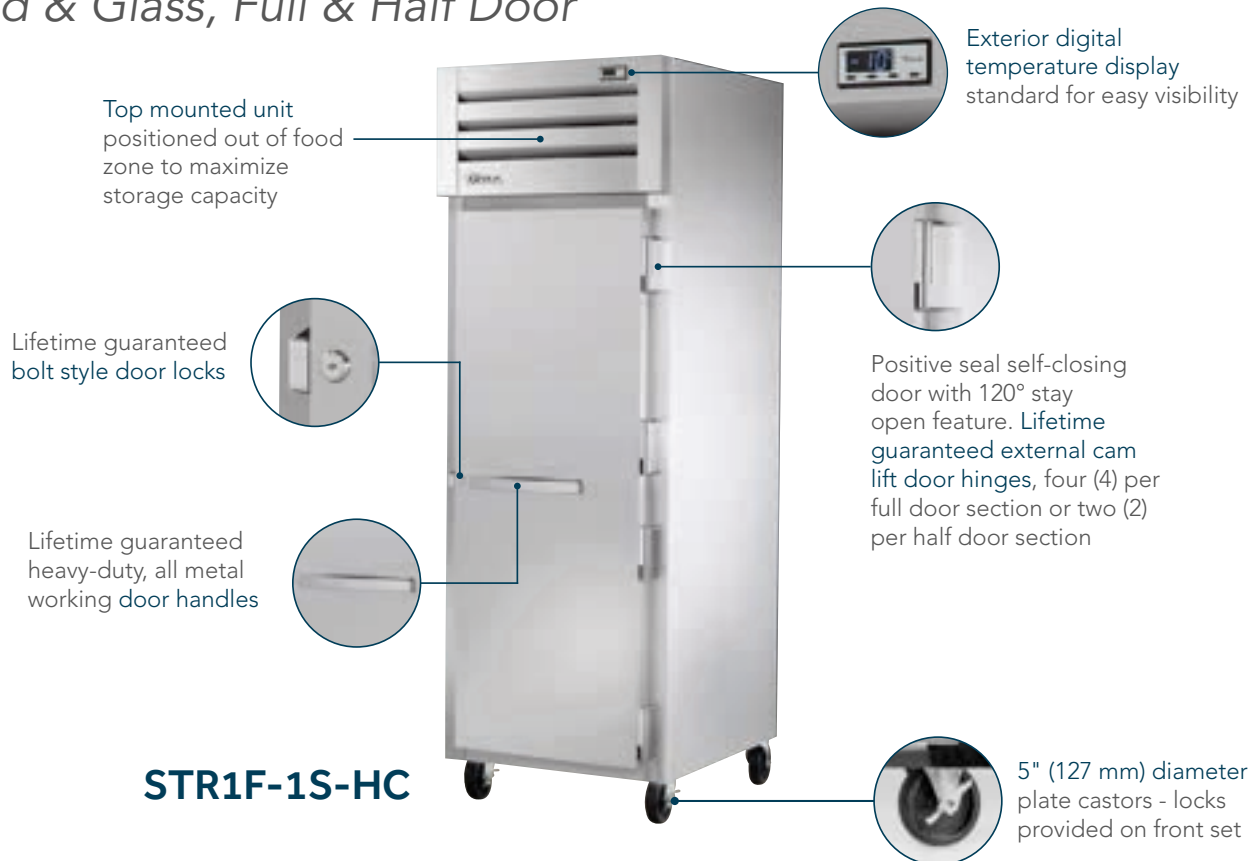

STR1F-1S-HC



STR1F-2HS-HC



STA1FPT-1S-1S-HC



STG2F-4HS-HC



STR3F-3S-HC

Features/Benefits

- Maintains cabinet -10°F (-23.3°C) temperatures. Ideal for both frozen foods and ice cream.
- State-of-the-art, electronically commutated evaporator and condenser fan motors. ECM motors operate at higher peak efficiencies, produce less heat and move a more consistent volume of air; all of these reduce energy consumption and provides greater motor reliability.
- Factory balanced, environmentally-friendly R290 Hydrocarbon forced-air refrigeration system.
- Automatic defrost system time-initiated, temperature-terminated. Saves energy consumption and provides shortest possible defrost cycle.
- Automatic evaporator fan motor delay during defrost cycle.
- Pilasters and tray slides/shelving are factory installed at no charge on STR units. (optional on STA/STG units).
- LED interior lighting, safety shielded.
- Energy efficient, triple pane, thermal insulated glass doors.
- Extruded, aluminum door frames on glass doors.
- STR - Stainless steel interior and exterior.
- STA - Exterior stainless steel. Interior is clear aluminum with stainless steel floor.
- STG - Exterior stainless steel door. Interior clear aluminum sides and back, stainless steel floor.



STR/STA/STG REACH-IN FREEZERS

Model	# of Doors	# of Shelves STA/STG models	HP	Amps	Crated Weight lb. (kg.)	Cabinet Dimensions W D† H* (in)	Cabinet Dimensions W D† H* (mm)
SOLID DOORS							
STR1F-1S-HC	1	3	½	6.0	450 (205)	27½ x 33¾ x 77¾	699 x 858 x 1975
STR2F-2S-HC	2	6	1¼	9.4	675 (307)	52⅝ x 33¾ x 77¾	1337 x 858 x 1975
STR3F-3S-HC	3	9	(2) ¾	13.8	980 (445)	77¾ x 33¾ x 77¾	1975 x 858 x 1975
SOLID HALF DOORS							
STR1F-2HS-HC	2	3	½	6.0	410 (186)	27½ x 33¾ x 77¾	699 x 858 x 1975
STR2F-4HS-HC	4	6	1¼	9.4	704 (320)	52⅝ x 33¾ x 77¾	1337 x 858 x 1975
STR3F-6HS-HC	6	9	(2) ½	13.8	936 (425)	77¾ x 33¾ x 77¾	1975 x 858 x 1975
GLASS DOORS							
STR1F-1G-HC	1	3	1	8.9	520 (236)	27½ x 33¾ x 77¾	699 x 858 x 1975
GLASS HALF DOORS							
STR1F-2HG-HC	2	3	1	8.9	410 (186)	27½ x 33¾ x 77¾	699 x 858 x 1975

† Depth does not include 1½" (39 mm) for door handles.

* Height does not include 6⅞" (156mm) for castors or 6" (153mm) for optional legs

* Height does not include ¼" (7mm) for system mechanical components.

‡ Require 208-230/60Hz, single phase, NEMA 6-15R.

note: Crated weight listed on the chart is for STR model, STA & STG versions may have different weights.

STR/STA/STG PASS-THRU FREEZERS

Model	# of Doors	# of Shelves STA/STG models	HP	Amps	Crated Weight lb. (kg.)	Cabinet Dimensions W D† H* (in)	Cabinet Dimensions W D† H* (mm)
SOLID DOORS							
STR1FPT-1S-1S	1 fr / 1 bk	3	¾	8.7	410 (186)	27½ x 36⅞ x 77¾	699 x 918 x 1975
SOLID HALF DOORS							
STR1FPT-2HS-2HS	2 fr / 2 bk	3	¾	8.7	410 (186)	27½ x 36⅞ x 77¾	699 x 918 x 1975

† Depth does not include 1½" (39 mm) for door handles.

* Height does not include 6⅞" (156mm) for castors or 6" (153mm) for optional legs

* Height does not include ¼" (7mm) for system mechanical components.

note: Crated weight listed on the chart is for STR model, STA & STG versions may have different weights.

Series Shelving

STR Series Shelving - (1) interior kit option included per full section at no charge.

(4) different interior kits available.

STA Series Shelving - (3) heavy-duty, chrome-plated wire shelves per section.

(4) different interior kits available.

STG Series Shelving - (3) heavy-duty, PVC-coated wire shelves per section.

(4) different interior kits available.

See "Spec Series accessories" (pg. 211) for additional details.

Top Mount Reach-Ins | SPEC SERIES® Freezers

STR/STA/STG ROLL-IN FREEZERS

Solid & Glass, Full Doors

Top mounted unit positioned out of food zone to maximize storage capacity

Lifetime guaranteed bolt style door locks

Lifetime guaranteed heavy-duty, all metal working door handles

Positive seal self-closing door with 120° stay open feature. Lifetime guaranteed external cam lift door hinges, three (3) per full door section

Exterior digital temperature display standard for easy visibility

STR1FRI-1S

One (1) heavy gauge stainless steel ramp per door

STR2FRI-2S

Features/Benefits

- An ideal -10°F (-23.3°C) for roll-in racks supporting frozen food and ice cream.
- Accepts roll-in rack (inboard castor) with maximum dimensions of 27"W x 29"D x 66"H (686mm x 737mm x 1677mm). STR/STA/STG1RRI89-1S and STR/STA/STG2RRI89-2S accept roll-in rack (inboard castor) with maximum dimensions of 27"W x 29"D x 72"H (686mm x 737mm x 1,829mm) (supplied by others).
- Factory engineered, self-contained, refrigeration system with capillary tube using environmentally-friendly 404A refrigerant.
- State-of-the-art, electronically commutated evaporator and condenser fan motors. ECM motors operate at higher peak efficiencies, produce less heat and move a more consistent volume of air; all of these reduce energy consumption and provides greater motor reliability.
- Incandescent interior lighting.
- STR - Stainless steel interior and exterior.
- STA - Exterior stainless steel. Interior is clear aluminum with stainless steel floor.
- STG - Exterior stainless steel door. Interior clear aluminum sides and back, stainless steel floor.
- Automatic defrost system time-initiated, temperature-terminated.
- Automatic evaporator fan motor delay during defrost cycle.



STR/STA/STG ROLL-IN FREEZERS

Model	# of Doors	HP	Amps	Crated Weight lb. (kg.)	Cabinet Dimensions W D† H* (in)	Cabinet Dimensions W D† H* (mm)
SOLID DOORS						
STR1FRI-1S	1	¾	12.0	410 (186)	35 x 34¾ x 83¾	889 x 883 x 2128
STR2FRI-2S ‡	2	1½	8.0	770 (350)	68 x 34¾ x 83¾	1728 x 883 x 2128

† Depth does not include 4¼" (108 mm) for ramp.

* Height does not include ¼" (7mm) for system mechanical components.

‡ Requires 115/208-230/60/1 Hz, single phase, 15 amp dedicated outlet.

note: Crated weight listed on the chart is for STR model, STA & STG versions may have different weights.

Bottom Mount Reach-Ins | DT - Dual Temperature

DT Series

Solid & Glass Full & Half Door Dual Temperature



T-23DT-G-HC-FGD01



T-49DT-HC



T-49DT-4-HC

Features/Benefits

- True's dual temperature models are equipped with two, independent, factory balanced, environmentally-friendly R290 Hydrocarbon forced-air refrigeration systems.
- Refrigerator holds 33°F to 38°F (0.5°C to 3.3°C) temperature. Freezer holds -10°F (-23.3°C).
- Exterior - Stainless steel front. Anodized quality aluminum ends. Corrosion resistant GalFan coated steel back.
- Interior - attractive, clear aluminum with stainless steel floor.
- Adjustable, heavy-duty, PVC-coated wire shelves.
- LED interior lighting. Safety shielded.
- Lifetime guaranteed recessed door handles on solid door models.
- Energy efficient, "Low-E", thermal insulated glass doors on glass door refrigerator models. Energy efficient, triple pane, thermal insulated glass doors on glass door freezer models.
- T23DT models feature refrigerator on top, freezer on bottom. T-49DT models feature refrigerator on left, freezer on right.
- T-49DT Freezer compartments feature standard backguard to improve airflow.
- Automatic defrost system.
- A "no-stoop", lower shelf.
- Compressor performs in the coolest, most grease-free area of kitchen for ease of compressor load.
- Compressor can be serviced easily, and accessed by a single repairman.



DT SERIES DUAL TEMPERATURE REFRIGERATOR/FREEZERS

Model	# of Doors	# of Shelves	HP Ref.	HP Frz.	Amps	Crated Weight lb. (kg.)	Cabinet Dimensions W D† H* (in)	Cabinet Dimensions W D† H* (mm)
SOLID DOORS								
T-23DT-HC	2	3	1/10	1/4	4.1	335 (152)	27 1/8 x 29 7/8 x 78 3/8	687 x 757 x 1991
T-49DT-HC	2	6	1/4	1/2	6.4	510 (232)	54 1/8 x 29 1/2 x 78 3/8	1375 x 750 x 1991
SOLID HALF DOORS								
T-49DT-4-HC	4	6	1/4	1/2	6.4	510 (232)	54 1/8 x 29 1/2 x 78 3/8	1375 x 750 x 1991
GLASS DOORS								
T-23DT-G-HC~FGD01	2	3	1/10	1/2	6.3	380 (173)	27 x 29 3/4 x 78 3/8	686 x 756 x 1991

† Depth does not include 1 3/8" (35 mm) for door handle(T-23DT-G-HC~FGD01 only).

* Height does not include 5" (127mm) for castors or 6" (153mm) for optional legs.

Top Mount Reach-Ins | SPEC SERIES® Dual Temperature

STR/STA/STG DUAL TEMPERATURE

Solid, Full & Half Doors

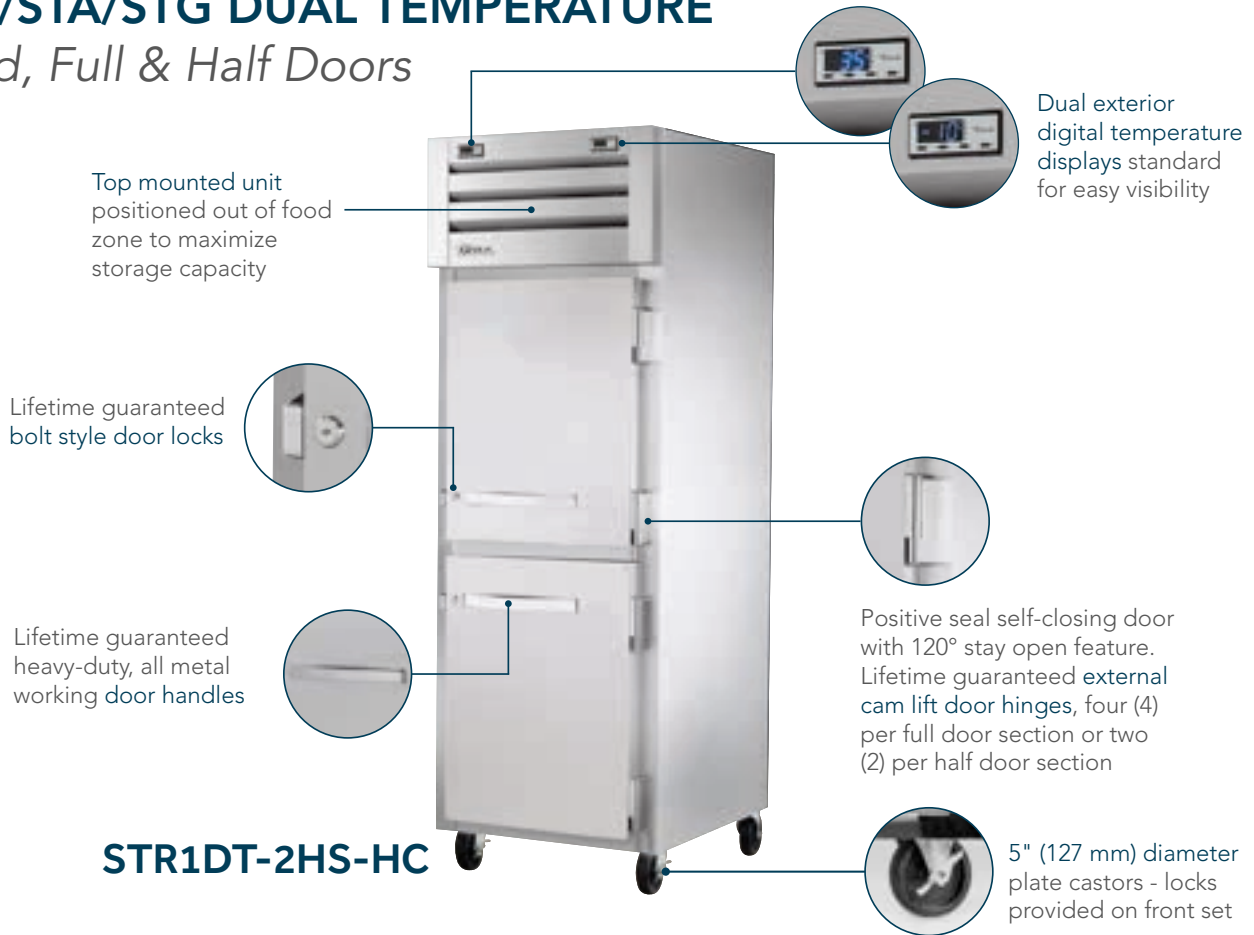

STR1DT-2HS-HC



STR1DTA-2HS-HC



STA2DT-2S



STA2DT-4HS

Features/Benefits

- Refrigerator section holds 33°F to 38°F (0.5°C to 3.3°C) temperature. Freezer section holds -10°F (-23.3°C).
- State-of-the-art, electronically commutated evaporator and condenser fan motors. ECM motors operate at higher peak efficiencies, produce less heat and move a more consistent volume of air; all of these reduce energy consumption and provides greater motor reliability.
- Factory balanced, environmentally-friendly R290 Hydrocarbon forced-air refrigeration system.
- Automatic defrost system time-initiated, temperature-terminated. Saves energy consumption and provides shortest possible defrost cycle.
- Automatic evaporator fan motor delay during defrost cycle.
- Pilasters and tray slides/shelving are factory installed at no charge on STR units. (optional on STA/STG units).
- LED interior lighting, safety shielded.
- Energy efficient, "Low-E", thermal insulated glass doors on glass door refrigerator models.
- Energy efficient, triple pane, thermal insulated glass doors on glass door freezer models.
- Extruded, aluminum door frames on glass doors.
- STR - Stainless steel interior and exterior.
- STA - Exterior stainless steel. Interior is clear aluminum with stainless steel floor.
- STG - Exterior stainless steel door. Interior clear aluminum sides and back, stainless steel floor.
- Self-contained system.



STR/STA/STG DUAL TEMPERATURE REFRIGERATOR/FREEZERS

Model	# of Doors	# of Shelves	HP Ref.	HP Frz.	Amps	Crated Weight lb. (kg.)	Cabinet Dimensions W D† H* (in)	Cabinet Dimensions W D† H* (mm)
SOLID FULL & HALF DOORS								
STR1DT-2HS-HC	2	3	1/10	1/4	3.7	500 (227)	27 1/2 x 33 3/4 x 77 3/4	699 x 858 x 1975
STR1DTA-2HS-HC	2	3	1/10	1/4	3.7	420 (191)	27 1/2 x 33 3/4 x 77 3/4	699 x 858 x 1975
STR2DT-2S	2	6	1/5	1/2	12.0	760 (345)	52 5/8 x 33 3/4 x 77 3/4	1337 x 858 x 1975
STR2DT-4HS	4	6	1/5	1/2	11.6	665 (302)	52 5/8 x 33 3/4 x 77 3/4	1337 x 858 x 1975

† Depth does not include 1 1/2" (39 mm) for door handles.

* Height does not include 6 1/8" (156mm) for castors or 6" (153mm) for optional legs

* Height does not include 1/4" (7mm) for system mechanical components.

note: Crated weight listed on the chart is for STR model, STA & STG versions may have different weights.

Series Shelving

STR Series Shelving - (1) interior kit option included per full section at no charge.
(4) different interior kits available.

STA Series Shelving - (3) heavy-duty, chrome-plated wire shelves per section.
(4) different interior kits available.

STG Series Shelving - (3) heavy-duty, PVC-coated wire shelves per section.
(4) different interior kits available.

See "Spec Series accessories" (pg. 211) for additional details.



FOOD PREP TABLES



True's food prep tables are designed with adaptability in mind. Each has flexible configurations that allow you to tailor your ingredient pans, helping reduce preparation time. True's exclusive airflow system locks in freshness while reducing energy costs by directing the coldest air off of the evaporator directly onto the food pans providing a uniform temperature throughout.





SANDWICH/SALAD UNITS

Solid Doors & Drawers

Stainless steel patented foam insulated cover keeps pans colder to lock in freshness & minimizes condensation



Optional Door and Drawer Configurations available in any section of cabinet



Extra Deep 11¾" (299mm) full length removable cutting boards

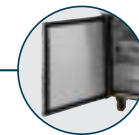
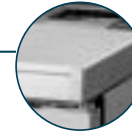

Swing Doors are self closing with 90° stay open feature



5" (127mm) diameter castors standard equipment (legs available)

TSSU-48-12-HC



TSSU-27-08-HC



TSSU-48-12D-4-HC



TSSU-60-16D-2-HC



TSSU-60-16-DS-ST-HC

Features/Benefits

- Maintains cold 33°F to 41°F (0.5°C to 5°C) product temperatures.
 - All stainless steel front, top and sides.
 - Corrosion resistant GalFan coated steel back.
 - Interior - attractive, clear aluminum sides and top, coved corners and stainless steel floor.
 - Recessed handles
 - Adjustable, heavy-duty, PVC-coated wire shelves (not available in drawered models).
 - Standard full set of (1/6 size) 6-7/8" L x 6-1/4" W x 4" D (175mm x 159mm x 102mm) NSF/ANSI approved, clear polycarbonate insert pans included (positioned in countertop). Also accommodates six and eight inch deep pans (drawered models will not accommodate 8" (204mm) deep condiment pans).
 - Available with optional 19" (483mm) white polyethylene or composite cutting board, crumb catcher or overshelf (19" (483mm) cutting boards exclude dual sided & drawered models).
 - ADA compliant models with 34" work surface height available.
 - All production of True models comply with NSF/ANSI standard 7.
- Dual Sided Models have...**
- Food prep access from both sides for high volume access along with the space efficiency of an island prep table.
 - Standard with 11¾" (299mm) white polyethylene cutting board.
- Drawer Models have...**
- Accommodate one 12" L x 20" W x 6" D (305mm x 508mm x 153mm) pan per drawer (drawer pans are not included). (48" (1,220mm) models accommodate one 12" L x 18" W x 6" D (305mm x 458mm x 153mm) food storage box or one 1/3 size and one 1/2 size pan per drawer; not included).
 - Door/drawer combination models require customer to designate door/drawer orientation.



TSSU® SANDWICH/SALAD UNITS

Model	Door/Drawers	# of Shelves	# of Pans (Top)	HP	Amps	Crated Weight lb. (kg.)	Cabinet Dimensions W D† H* (in)	Cabinet Dimensions W D† H* (mm)
WITH DOORS								
TSSU-27-08-HC	1/0	2	8	1/5	3.5	225 (102)	27 ³ / ₈ x 30 ¹ / ₈ x 36 ³ / ₄	702 x 766 x 934
TSSU-36-08-HC	2/0	4	8	1/4	4.5	255 (116)	36 ³ / ₈ x 30 ¹ / ₈ x 36 ³ / ₄	924 x 766 x 934
TSSU-48-08-HC	2/0	4	8	1/5	5.8	295 (134)	48 ³ / ₈ x 30 ¹ / ₈ x 36 ³ / ₄	1229 x 766 x 934
TSSU-48-10-HC	2/0	4	10	1/5	5.8	300 (136)	48 ³ / ₈ x 30 ¹ / ₈ x 36 ³ / ₄	1229 x 766 x 934
TSSU-48-12-HC	2/0	4	12	1/5	5.8	340 (155)	48 ³ / ₈ x 30 ¹ / ₈ x 36 ³ / ₄	1229 x 766 x 934
TSSU-60-08-HC	2/0	4	8	1/5	6.5	340 (155)	60 ³ / ₈ x 30 ¹ / ₈ x 36 ³ / ₄	1534 x 766 x 934
TSSU-60-10-HC	2/0	4	10	1/5	6.5	365 (166)	60 ³ / ₈ x 30 ¹ / ₈ x 36 ³ / ₄	1534 x 766 x 934
TSSU-60-12-HC	2/0	4	12	1/5	6.5	375 (171)	60 ³ / ₈ x 30 ¹ / ₈ x 36 ³ / ₄	1534 x 766 x 934
TSSU-60-16-HC	2/0	4	16	1/5	6.5	360 (164)	60 ³ / ₈ x 30 ¹ / ₈ x 36 ³ / ₄	1534 x 766 x 934
TSSU-72-08-HC	3/0	6	8	1/2	7.2	435 (198)	72 ³ / ₈ x 30 ¹ / ₈ x 36 ³ / ₄	1839 x 766 x 934
TSSU-72-10-HC	3/0	6	10	1/2	7.2	435(198)	72 ³ / ₈ x 30 ¹ / ₈ x 36 ³ / ₄	1839 x 766 x 934
TSSU-72-12-HC	3/0	6	12	1/2	7.2	445 (202)	72 ³ / ₈ x 30 ¹ / ₈ x 36 ³ / ₄	1839 x 766 x 934
TSSU-72-16-HC	3/0	6	16	1/2	7.2	440 (200)	72 ³ / ₈ x 30 ¹ / ₈ x 36 ³ / ₄	1839 x 766 x 934
TSSU-72-18-HC	3/0	6	18	1/2	7.2	445 (202)	72 ³ / ₈ x 30 ¹ / ₈ x 36 ³ / ₄	1839 x 766 x 934
WITH DRAWERS OR DOOR/DRAWER COMBO								
TSSU-27-08D-2-HC	0/2	N/A	8	1/5	3.5	240 (109)	27 ³ / ₈ x 30 ¹ / ₈ x 36 ³ / ₄	702 x 766 x 934
TSSU-48-12D-2-HC	1/2	2	12	1/5	5.8	340 (155)	48 ³ / ₈ x 30 ¹ / ₈ x 36 ³ / ₄	1229 x 766 x 934
TSSU-48-12D-4-HC	0/4	N/A	12	1/5	5.8	340 (155)	48 ³ / ₈ x 30 ¹ / ₈ x 36 ³ / ₄	1229 x 766 x 934
TSSU-60-16D-2-HC	1/2	2	16	1/5	6.5	405 (184)	60 ³ / ₈ x 30 ¹ / ₈ x 36 ³ / ₄	1534 x 766 x 934
TSSU-60-16D-4-HC	0/4	N/A	16	1/5	6.5	420 (191)	60 ³ / ₈ x 30 ¹ / ₈ x 36 ³ / ₄	1534 x 766 x 934
DUAL SIDED WITH DOORS								
TSSU-60-16-DS-ST-HC	2/0	4	16	1/5	6.5	425 (193)	60 ³ / ₈ x 38 ³ / ₄ x 31 ³ / ₈	1534 x 985 x 797

All models listed are available with optional crumb catcher.
 All models listed are available with optional 19" (483mm) cutting board (excludes drawered models).
 † Depth does not include 1" (26mm) for rear bumpers.
 * Height does not include 6¹/₄" (159mm) for castors or 6" (153mm) for optional legs. Height for all units are with the lid(s) closed.
 ** Width dimension does not include 1/8" (4mm) (each side) for lid pins, TSSU-27's only.
 note: Door/drawer combination cabinets require customer to designate door/drawer orientation.

TSSU® PAN DIVIDERS

Model	Standard	Dimensions D x W (in)	Dimensions D x W (mm)
PAN DIVIDERS FOR CONDIMENT PANS (top of cabinet)			
TSSU-27-08-HC	✓	1 x 25	26 x 645
TSSU-27-08-HC		7/8 x 25	23 x 645
TSSU-27-08-HC		7/8 x 25	23 x 645
TSSU Non-Mega		1 ⁵ / ₁₆ x 12 ⁵ / ₈	24 x 321
TSSU Non-Mega	✓	2 ⁷ / ₃₂ x 12 ⁵ / ₈	22 x 321
TSSU Non-Mega		1 x 12 ⁵ / ₁₆	26 x 320

Environmentally friendly R290 hydrocarbon refrigeration system for the best in food preservation.



Pan Configuration

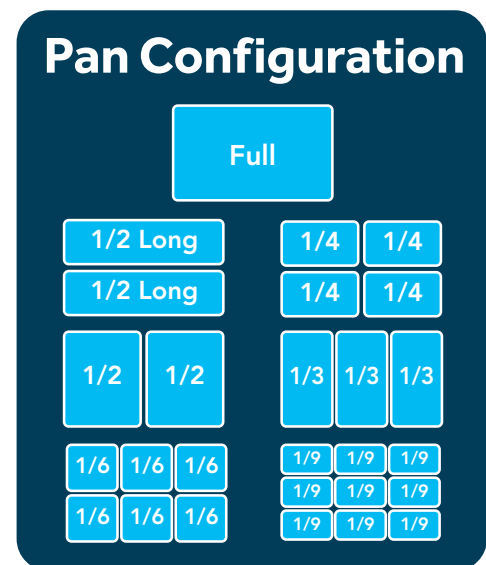

Incremental pan sizes designed to fit in full size pan opening in many different variations.

MEGA-TOP SANDWICH/SALAD UNITS

Solid Doors

Stainless steel patented foam insulated cover keeps pans colder to lock in freshness & minimizes condensation



8-7/8" (226mm) deep full length removable cutting board. Versatile, sanitary, white polyethylene cutting boards provide tough surface. Large comfortable working area

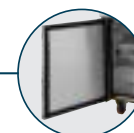
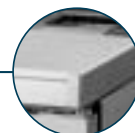

Swing Doors are self closing with 90° stay open feature



5" (127mm) diameter castors standard equipment (legs available)

TSSU-60-24M-B-ST-HC



TSSU-27-12M-B-HC



TSSU-36-12M-B-HC



TSSU-60-24M-B-DS-ST-HC



TSSU-72-30M-B-ST-FGLID-HC

Features/Benefits

- Maintains cold 33°F to 41°F (0.5°C to 5°C) product temperatures.
 - All stainless steel front, top and sides.
 - Corrosion resistant GalFan coated steel back.
 - Interior - attractive, clear aluminum sides and top, coved corners and stainless steel floor.
 - Recessed handles
 - Adjustable, heavy-duty, PVC-coated wire shelves (not available in drawered models).
 - Standard full set of (1/6 size) 6-7/8" L x 6-1/4" W x 4" D (175mm x 159mm x 102mm) NSF/ANSI approved, clear polycarbonate insert pans included (positioned in countertop). Also accommodates six and eight inch deep pans (drawered models will not accommodate 8" (204mm) deep condiment pans).
 - Available with optional 19" (483mm) white polyethylene or composite cutting board, crumb catcher or overshelf (19" (483mm) cutting boards exclude dual sided & drawered models).
 - Standard (1/6 size) 6-7/8" L x 6¼" W x 4" D (175mm x 159mm x 102mm) clear polycarbonate insert pans included. Also accommodates six and eight inch deep pans (except M-C model). (TSSU-27-12M-B-HC standard with nine 1/6 and three 1/9 size pans; TSSU-27-12M-C-HC standard with twelve 1/6 size pans); positioned in countertop.
 - ADA compliant models with 34" work surface height available.
 - All production of True models comply with NSF/ANSI standard 7.
- Dual Sided Models have...**
- Food prep access from both sides for high volume access along with the space efficiency of an island prep table.
 - Standard with 11¾" (299mm) white polyethylene cutting board.
- FGLID Models have...**
- Heavy-duty flat glass lid keeps pan temperatures colder and locks in freshness while enabling maximum product visibility.



TSSU® MEGA-TOP SANDWICH/SALAD UNITS

Model	Door/Drawers	# of Shelves	# of Pans (Top)	HP	Amps	Crated Weight lb. (kg.)	Cabinet Dimensions W D† H* (in)	Cabinet Dimensions W D† H* (mm)
WITH DOORS								
TSSU-27-12M-B-HC	1/0	2	12	1/5	3.5	225 (102)	27 ⁵ / ₈ x 34 ¹ / ₈ x 40 ³ / ₈	702 x 867 x 1026
TSSU-27-12M-C-HC	1/0	2	12	1/5	3.5	225 (102)	27 ⁵ / ₈ x 34 ¹ / ₈ x 40 ³ / ₈	702 x 867 x 1026
TSSU-36-12M-B-HC	2/0	4	12	1/4	4.5	255 (116)	36 ³ / ₈ x 34 ¹ / ₈ x 40 ³ / ₈	924 x 867 x 1026
TSSU-48-12M-B-HC	2/0	4	12	1/3	5.8	325 (148)	48 ³ / ₈ x 34 ¹ / ₈ x 40 ³ / ₈	1229 x 867 x 1026
TSSU-48-15M-B-HC	2/0	4	15	1/3	5.8	320 (146)	48 ³ / ₈ x 34 ¹ / ₈ x 40 ³ / ₈	1229 x 867 x 1026
TSSU-48-18M-B-HC	2/0	4	18	1/3	5.8	310 (141)	48 ³ / ₈ x 34 ¹ / ₈ x 40 ³ / ₈	1229 x 867 x 1026
TSSU-60-12M-B-HC	2/0	4	12	1/3	6.5	370 (168)	60 ³ / ₈ x 34 ¹ / ₈ x 40 ³ / ₈	1534 x 867 x 1026
TSSU-60-15M-B-HC	2/0	4	15	1/3	6.5	370 (168)	60 ³ / ₈ x 34 ¹ / ₈ x 40 ³ / ₈	1534 x 867 x 1026
TSSU-60-18M-B-HC	2/0	4	18	1/3	6.5	385 (175)	60 ³ / ₈ x 34 ¹ / ₈ x 40 ³ / ₈	1534 x 867 x 1026
TSSU-60-24M-B-ST-HC	2/0	4	24	1/3	6.5	385 (175)	60 ³ / ₈ x 34 ¹ / ₈ x 40 ³ / ₈	1534 x 867 x 1026
TSSU-72-12M-B-HC	3/0	6	12	1/2	7.2	440 (200)	72 ³ / ₈ x 34 ¹ / ₈ x 40 ³ / ₈	1839 x 867 x 1026
TSSU-72-15M-B-HC	3/0	6	15	1/2	7.2	445 (202)	72 ³ / ₈ x 34 ¹ / ₈ x 40 ³ / ₈	1839 x 867 x 1026
TSSU-72-18M-B-HC	3/0	6	18	1/2	7.2	445 (202)	72 ³ / ₈ x 34 ¹ / ₈ x 40 ³ / ₈	1839 x 867 x 1026
TSSU-72-24M-B-ST-HC	3/0	6	24	1/2	7.2	455 (207)	72 ³ / ₈ x 34 ¹ / ₈ x 40 ³ / ₈	1839 x 867 x 1026
TSSU-72-30M-B-ST-HC	3/0	6	30	1/2	7.2	460 (209)	72 ³ / ₈ x 34 ¹ / ₈ x 40 ³ / ₈	1839 x 867 x 1026
DUAL SIDED WITH DOORS								
TSSU-60-24M-B-DS-ST-HC	2/0	4	24	1/3	6.5	420 (191)	60 ³ / ₈ x 40 ³ / ₈ x 31 ³ / ₈	1534 x 1026 x 797
TSSU-72-30M-B-DS-ST-HC	3/0	6	30	1/2	7.2	490 (223)	72 ³ / ₈ x 41 ⁷ / ₈ x 31 ³ / ₈	1839 x 1064 x 797
FLAT GLASS LID WITH DOORS								
TSSU-48-18M-B-FGLID-HC	2/0	4	18	1/3	5.8	310 (141)	48 ³ / ₈ x 34 ⁷ / ₈ x 31 ⁷ / ₈	1229 x 884 x 810
TSSU-60-24M-B-ST-FGLID-HC	2/0	4	24	1/3	6.5	385 (175)	60 ³ / ₈ x 34 ⁷ / ₈ x 31 ⁷ / ₈	1534 x 884 x 810
TSSU-72-30M-B-ST-FGLID-HC	3/0	6	30	1/2	7.2	460 (209)	72 ³ / ₈ x 34 ⁷ / ₈ x 31 ⁷ / ₈	1839 x 884 x 810

† Depth does not include 1" (26mm) for rear bumpers.

* Height does not include 6¹/₄" (159mm) for castors or 6" (153mm) for optional legs. Height for all units are with the lid(s) closed.

** Width dimension does not include 1/8" (4mm) (each side) for lid pins, TSSU-27's only.

note: M-B model standard with nine 1/6 and three 1/9 size pans.

TSSU® PAN DIVIDERS

Model	Standard	Dimensions D x W (in)	Dimensions D x W (mm)
PAN DIVIDERS FOR CONDIMENT PANS (top of cabinet)			
TSSU Mega	✓	1 x 20 ¹ / ₁₆	26 x 519
TSSU Mega		1 ⁵ / ₁₆ x 20 ¹ / ₁₆	24 x 519
TSSU Mega		7 ⁸ / ₁₆ x 20 ¹ / ₁₆	23 x 519

Environmentally friendly R290 hydrocarbon refrigeration system for the best in food preservation.



Pan Configuration

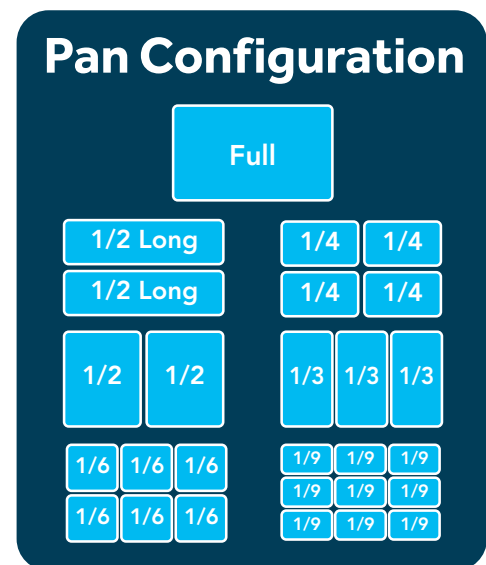

Incremental pan sizes designed to fit in full size pan opening in many different variations.

SANDWICH/SALAD UNITS ~SPEC3 SERIES

Solid Doors & Drawers

Stainless steel patented foam insulated cover keeps pans colder to lock in freshness & minimizes condensation



Extra deep 11¾" (299mm) full length removable cutting board on standard models. Versatile, sanitary, white polyethylene cutting boards provide tough surface. Large comfortable working area

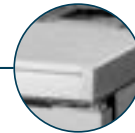

Door and drawer locks standard



Exterior digital temperature control and display



Swing Doors are self closing with 90° stay open feature

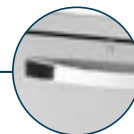

Lifetime -guaranteed heavy duty all metal working spec door/drawer handles



5" (127mm) diameter castors standard equipment (legs available)

TSSU-48-12D-2-HC~SPEC3



TSSU-27-08D-2-HC~SPEC3



TSSU-36-08-HC~SPEC3



TSSU-60-16D-2-HC~SPEC3



TSSU-72-16-HC~SPEC3

Features/Benefits

- Maintains cold 33°F to 41°F (0.5°C to 5°C) product temperatures.
- All stainless steel front, countertop, sides and back.
- Corrosion resistant GalFan coated steel back.
- Interior features stainless steel liner and stainless steel floor with coved corners.
- Heavy-duty top and 20 gauge door and drawer fronts.
- Adjustable, heavy-duty, PVC-coated wire shelves (not available in drawered models).
- Available with optional white polyethylene or composite cutting board, crumb catcher or overshelf (19" (483mm) cutting boards exclude dual sided & drawered models).
- Heavy-duty stainless steel drawer slides and rollers are removable without tools for easy cleaning on drawer models.
- ADA compliant models with 34" (864mm) work surface height available.
- All production of True models comply with NSF/ANSI standard 7.

Dual Sided Models have...

- Food prep access from both sides for high volume access along with the space efficiency of an island prep table.
- Standard with 11¾" (299mm) white polyethylene cutting board.

Drawer Models have...

- Accommodate one 12" L x 20" W x 6" D (305mm x 508mm x 153mm) pan per drawer (drawer pans are not included). (48" (1,220mm) models accommodate one 12" L x 18" W x 6" D (305mm x 458mm x 153mm) food storage box or one 1/3 size and one 1/2 size pan per drawer; not included).
- Door/drawer combination models require customer to designate door/drawer orientation.

FGLID Models have...

- Heavy-duty flat glass lid keeps pan temperatures colder and locks in freshness while enabling maximum product visibility.



TSSU® SANDWICH/SALAD UNITS ~SPEC3 SERIES

Model	Door/Drawers	# of Shelves	# of Pans (Top)	HP	Amps	Crated Weight lb. (kg.)	Cabinet Dimensions W D† H* (in)	Cabinet Dimensions W D† H* (mm)
WITH DOORS								
TSSU-27-08-HC~SPEC3	1/0	2	8	½	3.5	215 (98)	27¾ x 30½ x 36½	703 x 766 x 929
TSSU-36-08-HC~SPEC3	2/0	4	8	¼	4.5	255 (116)	36¾ x 30½ x 36¾	924 x 766 x 934
TSSU-48-08-HC~SPEC3	2/0	4	8	½	5.8	295 (134)	48¾ x 30½ x 36¾	1229 x 766 x 934
TSSU-48-10-HC~SPEC3	2/0	4	10	½	5.8	300 (137)	48¾ x 30½ x 36¾	1229 x 766 x 934
TSSU-48-12-HC~SPEC3	2/0	4	12	½	5.8	290 (132)	48¾ x 30½ x 36¾	1229 x 766 x 934
TSSU-60-08-HC~SPEC3	2/0	4	8	½	6.5	340 (155)	60¾ x 30½ x 36¾	1534 x 766 x 934
TSSU-60-10-HC~SPEC3	2/0	4	10	½	6.5	365 (166)	60¾ x 30½ x 36¾	1534 x 766 x 934
TSSU-60-12-HC~SPEC3	2/0	4	12	½	6.5	375 (170)	60¾ x 30½ x 36¾	1534 x 766 x 934
TSSU-60-16-HC~SPEC3	2/0	4	16	½	6.5	375 (170)	60¾ x 30½ x 36¾	1534 x 766 x 934
TSSU-72-08-HC~SPEC3	3/0	6	8	½	7.2	435 (198)	72¾ x 30½ x 36¾	1839 x 766 x 934
TSSU-72-10-HC~SPEC3	3/0	6	10	½	7.2	435 (198)	72¾ x 30½ x 36¾	1839 x 766 x 934
TSSU-72-12-HC~SPEC3	3/0	6	12	½	7.2	445 (202)	72¾ x 30½ x 36¾	1839 x 766 x 934
TSSU-72-16-HC~SPEC3	3/0	6	16	½	7.2	445 (202)	72¾ x 30½ x 36¾	1839 x 766 x 934
TSSU-72-18-HC~SPEC3	3/0	6	18	½	7.2	445 (202)	72¾ x 30½ x 36¾	1839 x 766 x 934
WITH DRAWERS OR DOOR/DRAWER COMBO								
TSSU-27-08D-2-HC~SPEC3	0/2	N/A	8	½	3.5	240 (109)	27¾ x 30½ x 36¾	702 x 766 x 934
TSSU-48-12D-2-HC~SPEC3	1/2	2	12	½	5.8	325 (103)	48¾ x 30½ x 36¾	1229 x 766 x 934
TSSU-48-12D-4-HC~SPEC3	0/4	N/A	12	½	5.8	340 (155)	48¾ x 30½ x 36¾	1229 x 766 x 934
TSSU-60-16D-2-HC~SPEC3	1/2	2	16	½	6.5	405 (184)	60¾ x 30½ x 36¾	1534 x 766 x 934
TSSU-60-16D-4-HC~SPEC3	0/4	N/A	16	½	6.5	420 (191)	60¾ x 30½ x 36¾	1534 x 766 x 934
DUAL SIDED WITH DOORS								
TSSU-60-16-DS-ST-HC~SPEC3	2/0	4	16	½	6.5	425 (193)	60¾ x 38¾ x 31¾	1534 x 985 x 797

† Depth does not include 1" (26mm) for rear bumpers.

* Height does not include 6¼" (159mm) for castors or 6" (153mm) for optional legs. Height for all units are with the lid(s) closed.

** Width dimension does not include ½" (4mm) (each side) for lid pins, TSSU-27's only.

Environmentally friendly R290 hydrocarbon refrigeration system for the best in food preservation.



MEGA-TOP SANDWICH/SALAD UNITS ~SPEC3 SERIES

Solid Doors & Drawers



TSSU-48-18M-B-HC~SPEC3



TSSU-27-12M-C-HC-SPEC3



TSSU-36-12M-B-HC~SPEC3



TSSU-60-24M-B-DS-ST-HC-SPEC3



TSSU-60-24M-B-ST-FGLID-HC-SPEC3

Features/Benefits

- Maintains cold 33°F to 41°F (0.5°C to 5°C) product temperatures.
- All stainless steel front, countertop, sides and back.
- Corrosion resistant GalFan coated steel back.
- Interior features stainless steel liner and stainless steel floor with covered corners.
- Heavy-duty top and 20 gauge doors.
- Adjustable, heavy-duty, gray PVC-coated wire shelves
- ADA compliant models with 34" work surface height available.
- All production of True models comply with NSF/ANSI standard 7.

Dual Sided Models have...

- Food prep access from both sides for high volume access along with the space efficiency of an island prep table.
- 8-7/8" (226mm) deep full length removable white polyethylene cutting board.

FGLID Models have...

- Heavy-duty flat glass lid keeps pan temperatures colder and locks in freshness while enabling maximum product visibility.



TSSU® MEGA-TOP SANDWICH/SALAD UNITS ~SPEC3 SERIES

Model	Door/Drawers	# of Shelves	# of Pans (Top)	HP	Amps	Crated Weight lb. (kg.)	Cabinet Dimensions W D† H* (in)	Cabinet Dimensions W D† H* (mm)
WITH DOORS								
TSSU-27-12M-B-HC~SPEC3	1/0	2	12	1/5	3.5	235 (107)	27 ⁷ / ₈ x 34 ¹ / ₈ x 40 ³ / ₈	702 x 867 x 1026
TSSU-27-12M-C-HC~SPEC3	1/0	2	12	1/5	3.5	225 (103)	27 ⁷ / ₈ x 34 ¹ / ₈ x 40 ³ / ₈	702 x 867 x 1026
TSSU-36-12M-B-HC~SPEC3	2/0	4	12	1/4	4.5	255 (116)	36 ³ / ₈ x 34 ¹ / ₈ x 40 ³ / ₈	924 x 867 x 1026
TSSU-48-12M-B-HC~SPEC3	2/0	4	12	1/3	5.8	325 (148)	48 ³ / ₈ x 34 ¹ / ₈ x 40 ³ / ₈	1229 x 867 x 1026
TSSU-48-15M-B-HC~SPEC3	2/0	4	15	1/3	5.8	325 (148)	48 ³ / ₈ x 34 ¹ / ₈ x 40 ³ / ₈	1229 x 867 x 1026
TSSU-48-18M-B-HC~SPEC3	2/0	4	18	1/3	5.8	330 (150)	48 ³ / ₈ x 34 ¹ / ₈ x 40 ³ / ₈	1229 x 867 x 1026
TSSU-60-12M-B-HC~SPEC3	2/0	4	12	1/3	6.5	370 (168)	60 ³ / ₈ x 34 ¹ / ₈ x 40 ³ / ₈	1534 x 867 x 1026
TSSU-60-15M-B-HC~SPEC3	2/0	4	15	1/3	6.5	TBD	60 ³ / ₈ x 34 ¹ / ₈ x 40 ³ / ₈	1534 x 867 x 1026
TSSU-60-18M-B-HC~SPEC3	2/0	4	18	1/3	6.5	385 (175)	60 ³ / ₈ x 34 ¹ / ₈ x 40 ³ / ₈	1534 x 867 x 1026
TSSU-60-24M-B-ST-HC~SPEC3	2/0	4	24	1/3	6.5	385 (175)	60 ³ / ₈ x 34 ¹ / ₈ x 40 ³ / ₈	1534 x 867 x 1026
TSSU-72-12M-B-HC~SPEC3	3/0	6	12	1/2	7.2	TBD	72 ³ / ₈ x 34 ¹ / ₈ x 40 ³ / ₈	1839 x 867 x 1026
TSSU-72-15M-B-HC~SPEC3	3/0	6	15	1/2	7.2	TBD	72 ³ / ₈ x 34 ¹ / ₈ x 40 ³ / ₈	1839 x 867 x 1026
TSSU-72-18M-B-HC~SPEC3	3/0	6	18	1/2	7.2	TBD	72 ³ / ₈ x 34 ¹ / ₈ x 40 ³ / ₈	1839 x 867 x 1026
TSSU-72-24M-B-ST-HC~SPEC3	3/0	6	24	1/2	7.2	455 (207)	72 ³ / ₈ x 34 ¹ / ₈ x 40 ³ / ₈	1839 x 867 x 1026
TSSU-72-30M-B-ST-HC~SPEC3	3/0	6	30	1/2	7.2	460 (209)	72 ³ / ₈ x 34 ¹ / ₈ x 40 ³ / ₈	1839 x 867 x 1026
DUAL SIDED WITH DOORS								
TSSU-60-24M-B-DS-ST-HC~SPEC3	2/0	4	24	1/3	6.5	420 (191)	60 ³ / ₈ x 40 ³ / ₈ x 31 ³ / ₈	1534 x 1026 x 797
TSSU-72-30M-B-DS-ST-HC~SPEC3	3/0	6	30	1/2	7.2	490 (223)	72 ³ / ₈ x 41 ⁷ / ₈ x 31 ³ / ₈	1839 x 1064 x 797
FLAT GLASS LID WITH DOORS								
TSSU-48-18M-B-FGLID-HC~SPEC3	2/0	4	18	1/3	5.8	310 (141)	48 ³ / ₈ x 34 ⁷ / ₈ x 31 ⁷ / ₈	1229 x 884 x 810
TSSU-60-24M-B-ST-FGLID-HC~SPEC3	2/0	4	24	1/3	6.5	385 (175)	60 ³ / ₈ x 34 ⁷ / ₈ x 31 ⁷ / ₈	1534 x 884 x 810
TSSU-72-30M-B-ST-FGLID-HC~SPEC3	3/0	6	30	1/2	7.2	460 (209)	72 ³ / ₈ x 34 ⁷ / ₈ x 31 ⁷ / ₈	1839 x 884 x 810

† Depth does not include 1" (26mm) for rear bumpers.

* Height does not include 6¹/₄" (159mm) for castors or 6" (153mm) for optional legs. Height for all units are with the lid(s) closed.

** Width dimension does not include 1/8" (4mm) (each side) for lid pins, TSSU-27's only.

note: M-B model standard with nine 1/6 and three 1/9 size pans.

Environmentally friendly R290 hydrocarbon refrigeration system for the best in food preservation.



AMERICAN DISABILITY ACT (ADA) COMPLIANT PACKAGES

Solid Doors & Drawers



ADA models feature 3" (77mm) diameter castors



TSSU-48-12-HC

Features/Benefits

- True sandwich/salad units are designed to accommodate American Disabilities Act (ADA) requirements.
- ADA Compliant models have 3" (127mm) castors
- ADA Compliant models have 34" (864mm) counter heights.

True Sandwich/Salad Units Are Designed To Accommodate American Disabilities Act (ADA) Requirements.

PLAN VIEW COMPARISON

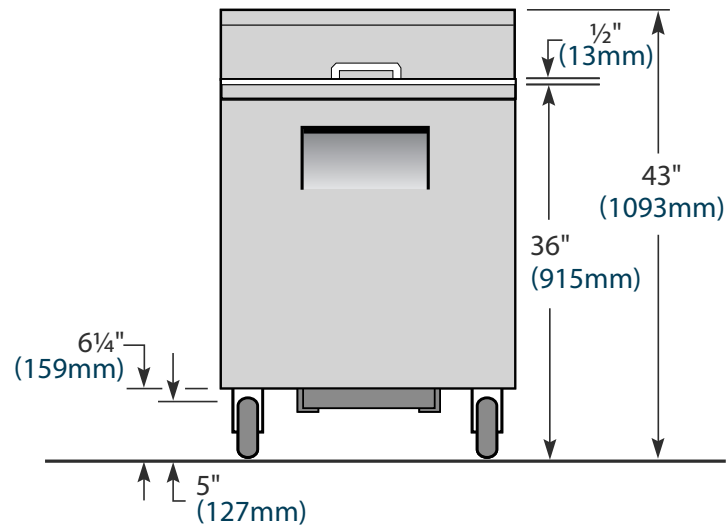

Standard

36" (915mm) Height

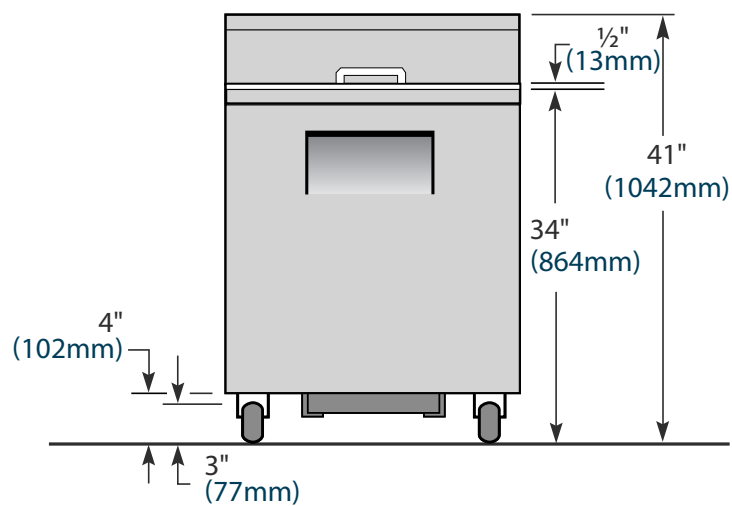

ADA Compliant

34" (864mm) Height

FOOD PREP UNITS & FOOD PREP UNITS ~SPEC3 SERIES

Solid Doors & Drawers

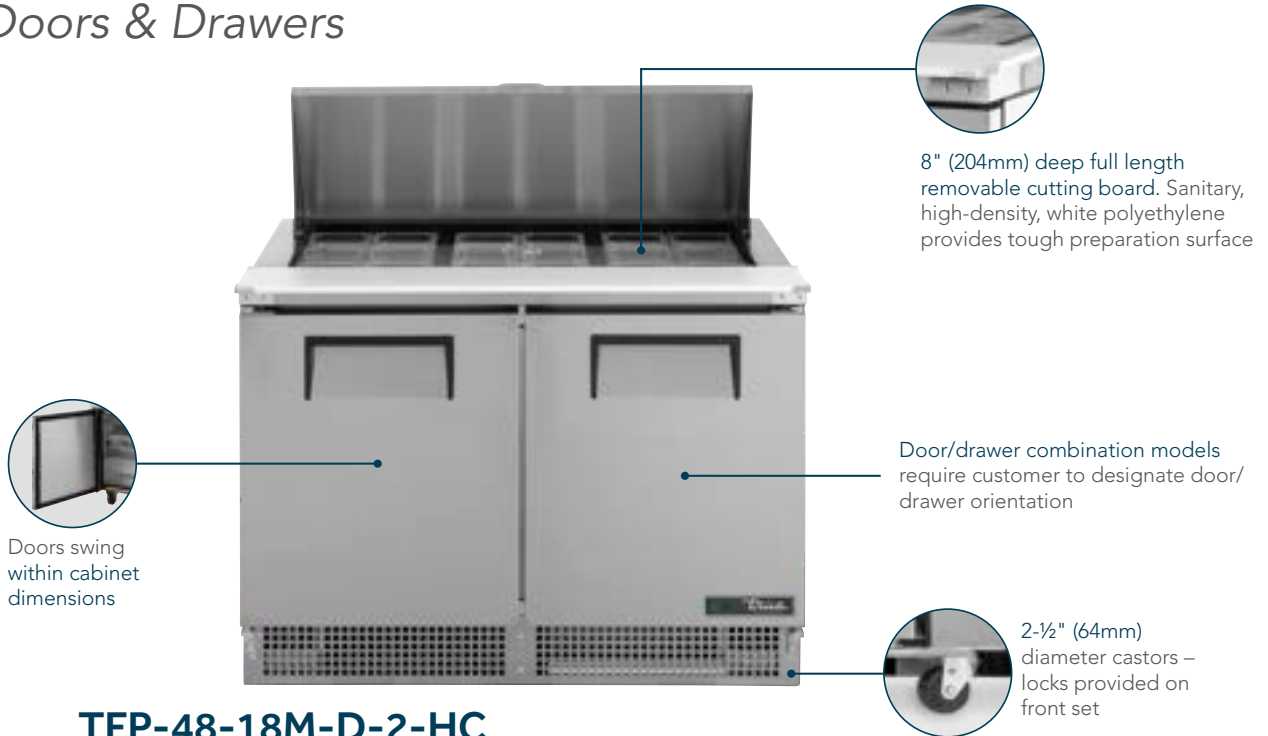

TFP-48-18M-D-2-HC



TFP-32-12M-HC



TFP-64-24M-FGLID-HC



TFP-72-30M-D-4-HC



TFP-72-30M-HC-SPEC3

Features/Benefits

- Maintains cold 33°F to 41°F (0.5°C to 5°C) product temperatures.
- Oversized and balanced (134A), refrigeration system, with guided airflow directed to provide uniform temperature in food pans and cabinet interior.
- All stainless steel front, top and sides.
- Corrosion resistant GalFan coated steel back.
- Interior - attractive, clear aluminum sides and top, coved corners and stainless steel floor.
- Recessed handles
- Adjustable, heavy-duty, PVC-coated wire shelves (not available in drawered sections).
- TFP-32-12M-D-2 & TFP-64-24M-D-4 Each drawer accommodates two (2) full size 12" L x 20" W x 6" D (305 mm x 508 mm x 153 mm) food pan (sold separately). Drawer will support varying size pan configurations with available pan divider bars (drawer pans sold separately).
- TFP-48-18M-D-4 & TFP-72-30M-D-6 Each drawer accommodates one (1) full size 12" L x 20" W x 6" D (305 mm x 508 mm x 153 mm) food pan & three (3) 1/9 size or six (6) 1/6 size & three (3) 1/9 size pans per drawer

- (sold separately). Drawer will support varying size pan configurations with available pan divider bars (drawer pans sold separately).
- Self-contained system.
- Front breathing.
- Work surface 36" (915mm) high.
- NSF/ANSI standard 7 compliant for open food product.
- Available with optional single and double over shelves. Consult factory for model specific availability.

~SPEC3 Models have...

- All stainless steel front, countertop, sides, and back.
- Interior features stainless steel liner and stainless steel floor with coved corners.
- Heavy-duty top and 20 gauge door and drawer fronts.
- Lifetime-guaranteed heavy duty all metal working spec door/drawer handles.
- Door and drawer locks standard.
- Exterior digital temperature control and display.



TFP® FOOD PREP UNITS

Model	Door/Drawers	# of Shelves	# of Pans (Top)	HP	Amps	Crated Weight lb. (kg.)	Cabinet Dimensions W D† H* (in)	Cabinet Dimensions W D† H* (mm)
WITH DOORS								
TFP-32-12M-HC	1/0	2	12	1/5	3.3	315 (143)	32 1/8 x 31 1/2 x 45 3/4	816 x 801 x 1162
TFP-48-18M-HC	2/0	4	18	1/5	2.9	380 (173)	48 1/8 x 31 1/2 x 45 3/4	1223 x 801 x 1162
TFP-64-24M-HC	2/0	4	24	1/2	7.6	570 (259)	64 1/8 x 31 1/2 x 45 3/4	1629 x 801 x 1162
TFP-72-30M-HC	3/0	6	30	1/2	8.1	530 (241)	72 1/8 x 31 1/2 x 45 3/4	1832 x 801 x 1162
WITH DRAWERS OR DOOR/DRAWER COMBO								
TFP-32-12M-D-2-HC	0/2	N/A	12	1/5	3.3	315 (143)	32 1/8 x 31 1/2 x 45 3/4	816 x 801 x 1162
TFP-48-18M-D-2-HC	1/2	2	18	1/5	2.9	480 (218)	48 1/8 x 31 1/2 x 45 3/4	1223 x 801 x 1162
TFP-48-18M-D-4-HC	0/4	N/A	18	1/5	2.9	480 (218)	48 1/8 x 31 1/2 x 45 3/4	1223 x 801 x 1162
TFP-64-24M-D-2-HC	1/2	2	24	1/2	7.6	570 (259)	64 1/8 x 31 1/2 x 45 3/4	1629 x 801 x 1162
TFP-64-24M-D-4-HC	0/4	N/A	24	1/2	7.6	570 (259)	64 1/8 x 31 1/2 x 45 3/4	1629 x 801 x 1162
TFP-72-30M-D-2-HC	2/2	4	30	1/2	8.1	635 (289)	72 1/8 x 31 1/2 x 45 3/4	1832 x 801 x 1162
TFP-72-30M-D-4-HC	1/4	2	30	1/2	8.1	635 (289)	72 1/8 x 31 1/2 x 45 3/4	1832 x 801 x 1162
TFP-72-30M-D-6-HC	0/6	N/A	30	1/2	8.1	635 (289)	72 1/8 x 31 1/2 x 45 3/4	1832 x 801 x 1162
FLAT GLASS LID WITH DOORS								
TFP-48-18M-FGLID-HC	2/0	4	18	1/5	2.9	380 (173)	48 1/8 x 32 1/4 x 37 1/4	1223 x 820 x 946
TFP-64-24M-FGLID-HC	2/0	4	24	1/2	7.6	570 (259)	64 1/8 x 32 1/4 x 37 1/4	1629 x 820 x 946
TFP-72-30M-FGLID-HC	3/0	6	30	1/2	8.1	530 (240)	72 1/8 x 32 1/4 x 37 1/4	1832 x 820 x 946

† Depth does not include 2" (51mm) for cutting board.

* Height does not include 3/4" (19mm) for castors. Height for all units are with the lid(s) closed.

* Height on FGLID models does not include 21 1/2" (550mm) for open lid. Total height with castors and lid open is 59 1/2" (1515mm).

TFP® FOOD PREP UNITS ~SPEC3 SERIES

Model	Door/Drawers	# of Shelves	# of Pans (Top)	HP	Amps	Crated Weight lb. (kg.)	Cabinet Dimensions W D† H* (in)	Cabinet Dimensions W D† H* (mm)
WITH DOORS								
TFP-32-12M-HC~SPEC3	1/0	2	12	1/5	3.3	315 (143)	32 1/8 x 31 1/2 x 45 3/4	816 x 801 x 1162
TFP-48-18M-HC~SPEC3	2/0	4	18	1/5	2.9	375 (171)	48 1/8 x 31 1/2 x 45 3/4	1223 x 801 x 1162
TFP-64-24M-HC~SPEC3	2/0	4	24	1/2	7.6	570 (259)	64 1/8 x 31 1/2 x 45 3/4	1629 x 801 x 1162
TFP-72-30M-HC~SPEC3	3/0	6	30	1/2	8.1	530 (241)	72 1/8 x 31 1/2 x 45 3/4	1832 x 801 x 1162
WITH DRAWERS OR DOOR/DRAWER COMBO								
TFP-32-12M-D-2-HC~SPEC3	0/2	N/A	12	1/5	3.3	325 (148)	32 1/8 x 31 1/2 x 45 3/4	816 x 801 x 1162
TFP-48-18M-D-4-HC~SPEC3	0/4	N/A	18	1/5	2.9	480 (218)	48 1/8 x 31 1/2 x 45 3/4	1223 x 801 x 1162
TFP-64-24M-D-4-HC~SPEC3	0/4	N/A	24	1/2	7.6	570 (259)	64 1/8 x 31 1/2 x 45 3/4	1629 x 801 x 1162
TFP-72-30M-D-6-HC~SPEC3	0/6	N/A	30	1/2	8.1	530 (241)	72 1/8 x 31 1/2 x 45 3/4	1832 x 801 x 1162
FLAT GLASS LID WITH DOORS								
TFP-48-18M-FGLID-HC~SPEC3	2/0	4	18	1/5	2.9	480 (218)	48 1/8 x 32 1/4 x 37 1/4	1223 x 820 x 946
TFP-64-24M-FGLID-HC~SPEC3	2/0	4	24	1/2	7.6	570 (259)	64 1/8 x 32 1/4 x 37 1/4	1629 x 820 x 946
TFP-72-30M-FGLID-HC~SPEC3	3/0	6	30	1/2	8.1	530 (241)	72 1/8 x 32 1/4 x 37 1/4	1832 x 820 x 946

† Depth does not include 2" (51mm) for cutting board.

* Height does not include 3/4" (19mm) for castors. Height for all units are with the lid(s) closed.

* Height on FGLID models does not include 21 1/2" (550mm) for open lid. Total height with castors and lid open is 59 1/2" (1515mm).

True has 3 different widths of spacer bars to accommodate the needs of the end user: Because plastic and stainless pan manufacturers have different dimensions, widths and sizes, our spacer bars will allow the end user to design almost any pan configuration. See accessory section for pan sizes and configuration.

Environmentally friendly R290 hydrocarbon refrigeration system for the best in food preservation.



PIZZA PREP TABLES & PIZZA PREP TABLES ~SPEC3 SERIES

Solid Doors & Drawers

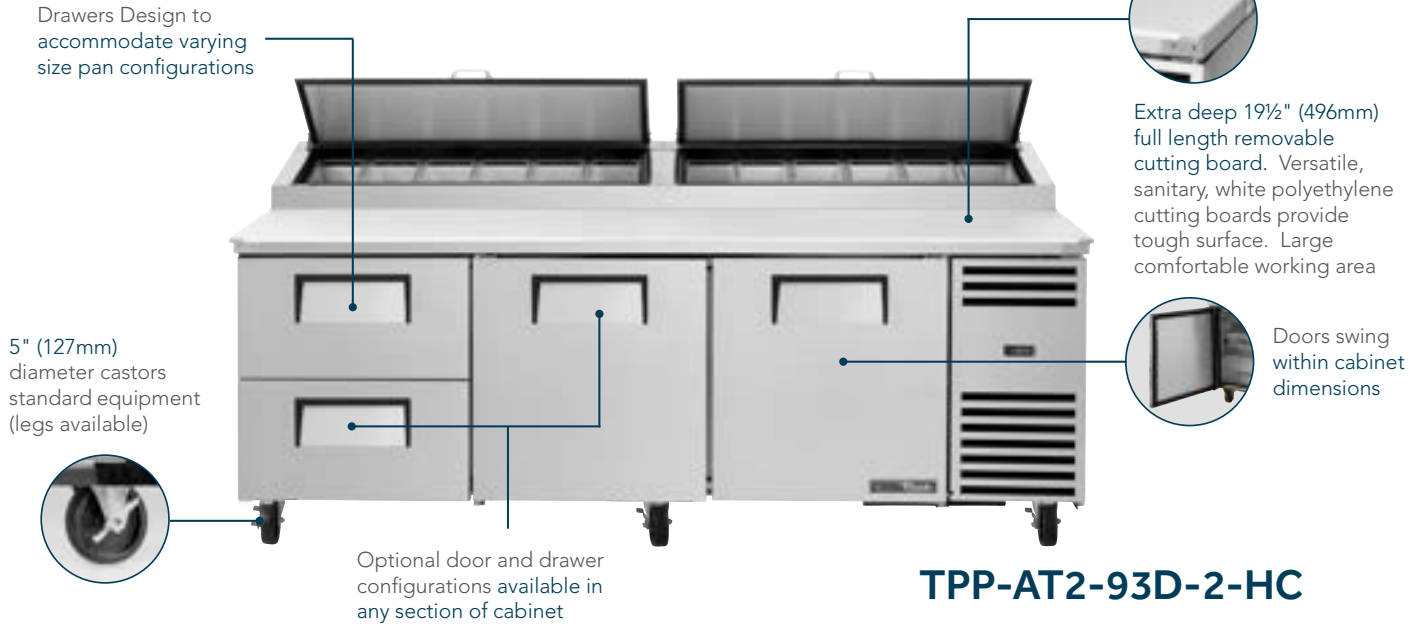

TPP-AT-44-HC



TPP-AT-60-HC



TPP-67D-4-HC-SPEC3



TPP-119-HC-SPEC3

Features/Benefits

- Maintains cold 33°F to 41°F (0.5°C to 5°C) product temperatures.
 - All stainless steel front, top and ends.
 - Corrosion resistant GalFan coated steel back.
 - Interior - attractive, clear aluminum sides and top, coved corners and stainless steel floor.
 - Recessed handles
 - Adjustable, heavy-duty, PVC-coated wire shelves (not available in drawered sections).
 - Standard full set of (1/3 size) 12-3/4" L x 6-1/4" W x 6" D (324mm x 159mm x 153mm) NSF approved, clear polycarbonate insert pans included in condiment rail.
 - Drawered models (drawered section only) will accommodate up to two 8" (204mm) deep full size pans (12" L x 20" W x 8" D (305mm x 508mm x 204mm)) per drawer. (pans not included).
 - Door models accommodate half bun tray rack; applies to only one door of TPP-60-AT-HC (18" (458mm) x 26" (661mm) sheet pan) - not included.
 - Self-contained system.
 - Front breathing.
 - Work surface 36" (915mm) high.
 - Rear bumpers.
 - NSF/ANSI standard 7 compliant for open food product.
 - Garnish rack and service shelf optional (service shelf is not available on TPP-119-AT's).
- ~SPEC3 Models have...**
- All stainless steel front, countertop, sides, and back.
 - Interior features stainless steel liner and stainless steel floor with coved corners.
 - Heavy-duty top and 20 gauge door and drawer fronts.
 - Lifetime-guaranteed heavy duty all metal working spec door/drawer handles.
 - Door and drawer locks standard.
 - Exterior digital temperature control and display.
- True has 3 different widths of spacer bars to accommodate the needs of the end user:

Because plastic and stainless pan manufacturers have different dimensions, widths and sizes, our spacer bars will allow the end user to design almost any pan configuration. See accessory section for pan sizes and configuration.



TPP® PIZZA PREP TABLES

Model	Door/Drawers	# of Shelves	# of Pans (Top)	HP	Amps	Crated Weight lb. (kg.)	Cabinet Dimensions W D† H* (in)	Cabinet Dimensions W D† H* (mm)
WITH DOORS								
TPP-AT-44-HC	1/0	2	6	¼	3.9	330 (150)	44½ x 33¾ x 38¾	1133 x 854 x 987
TPP-AT-60-HC	2/0	4	8	¼	3.9	410 (186)	60¼ x 33¾ x 38¾	1530 x 854 x 987
TPP-AT-67-HC	2/0	4	9	¼	3.9	455 (207)	67¾ x 33¾ x 38¾	1711 x 854 x 987
TPP-AT2-93-HC	3/0	6	12	¾	7.1	600 (273)	93¾ x 33¾ x 38¾	2372 x 854 x 987
TPP-AT-119-HC	4/0	8	15	¾	7.1	975 (443)	119¼ x 33¾ x 38¾	3029 x 854 x 987
WITH DRAWERS OR DOOR/DRAWER COMBO								
TPP-AT-44D-2-HC	0/2	N/A	6	¼	3.9	330 (150)	44½ x 33¾ x 38¾	1133 x 854 x 987
TPP-AT-60D-2-HC	1/2	2	8	¼	3.9	415 (189)	60¼ x 33¾ x 38¾	1530 x 854 x 987
TPP-AT-67D-2-HC	1/2	N/A	9	¼	3.9	455 (207)	67¾ x 33¾ x 38¾	1711 x 854 x 987
TPP-AT-67D-4-HC	0/4	2	9	¼	3.9	455 (207)	67¾ x 33¾ x 38¾	1711 x 854 x 987
TPP-AT2-93D-2-HC	2/2	4	12	¾	7.1	600 (273)	93¾ x 33¾ x 38¾	2372 x 854 x 987
TPP-AT2-93D-4-HC	1/4	2	12	¾	7.1	600 (273)	93¾ x 33¾ x 38¾	2372 x 854 x 987
TPP-AT2-93D-6-HC	0/6	N/A	12	¾	7.1	600 (273)	93¾ x 33¾ x 38¾	2372 x 854 x 987
TPP-AT-119D-2-HC	3/2	8	15	¾	7.1	975 (443)	119¼ x 33¾ x 38¾	3029 x 854 x 987
TPP-AT-119D-4-HC	2/4	4	15	¾	7.1	975 (443)	119¼ x 33¾ x 38¾	3029 x 854 x 987
TPP-AT-119D-6-HC	1/6	2	15	¾	7.1	975 (443)	119¼ x 33¾ x 38¾	3029 x 854 x 987
TPP-AT-119D-8-HC	0/8	N/A	15	¾	7.1	975 (443)	119¼ x 33¾ x 38¾	3029 x 854 x 987

† Depth does not include 1" (26 mm) for rear bumpers and 1¾" (44 mm) for cutting board. * Height does not include 5¾" (146 mm) for castors or 6" (153 mm) for optional legs. note: Door/drawer combination cabinets require customer to designate door/drawer orientation.

TPP® PIZZA PREP TABLES ~SPEC3 SERIES

Model	Door/Drawers	# of Shelves	# of Pans (Top)	HP	Amps	Crated Weight (kg.)	Cabinet Dimensions W D† H* (in)	Cabinet Dimensions W D† H* (mm)
WITH DOORS								
TPP-AT-44-HC~SPEC3	1/0	2	6	¼	3.9	330 (150)	44½ x 33¾ x 38¾	1133 x 854 x 987
TPP-AT-60-HC~SPEC3	2/0	4	8	¼	3.9	420 (191)	60¼ x 33¾ x 38¾	1530 x 854 x 987
TPP-AT-67-HC~SPEC3	2/0	4	9	¼	3.9	415 (188)	67¾ x 33¾ x 38¾	1711 x 854 x 987
TPP-AT2-93-HC~SPEC3	3/0	6	12	¾	7.1	600 (273)	93¾ x 33¾ x 38¾	2372 x 854 x 987
TPP-AT-119-HC~SPEC3	4/0	8	15	¾	7.1	725 (329)	119¼ x 33¾ x 38¾	3029 x 854 x 987
WITH DRAWERS OR DOOR/DRAWER COMBO								
TPP-AT-44D-2-HC~SPEC3	0/2	N/A	6	¼	3.9	330 (150)	44½ x 33¾ x 38¾	1133 x 854 x 987
TPP-AT-60D-2-HC~SPEC3	1/2	2	8	¼	3.9	415 (189)	60¼ x 33¾ x 38¾	1530 x 854 x 987
TPP-AT-67D-4-HC~SPEC3	0/4	N/A	9	¼	3.9	455 (207)	67¾ x 33¾ x 38¾	1711 x 854 x 987
TPP-AT2-93D-6-HC~SPEC3	0/6	N/A	12	¾	7.1	600 (273)	93¾ x 33¾ x 38¾	2372 x 854 x 987
TPP-AT-119D-8-HC~SPEC3	0/8	N/A	15	¾	7.1	975 (443)	119¼ x 33¾ x 38¾	3029 x 854 x 987

† Depth does not include 1" (26 mm) for rear bumpers and 1¾" (44 mm) for cutting board. * Height does not include 5¾" (146 mm) for castors or 6" (153 mm) for optional legs. note: Door/drawer combination cabinets require customer to designate door/drawer orientation.

TPP® TELESCOPING HOOD & TOPPING CATCHER OPTIONS

Model	Model
TELESCOPING HOOD	TOPPING CATCHER
TPP-AT-44's	TPP-AT-44's
TPP-AT-60's/TPP-AT-67's	TPP-AT-60's/TPP-AT-67's
TPP-AT2-93's	TPP-AT2-93's
TPP-AT-119's	TPP-AT-119's

Telescoping Hood & Topping Catcher options are available for all existing variations and voltages of TPP series models. Telescoping Hood & Topping Catcher options are available separately or combined. Telescoping Hood & Topping Catcher options are not field retrofittable.

TPP® PAN DIVIDERS

Model	Standard	Cabinet Dimensions D x W (in)	Cabinet Dimensions D x W (mm)
PAN DIVIDERS FOR CONDIMENT PANS (top of cabinet)			
TPP-AT-HC		15½ x 12½	24 x 320
TPP-AT-HC		27½ x 12½	24 x 320
TPP-AT-HC		1 x 12½	26 x 319
PAN DIVIDERS FOR DRAWERS			
TPP-AT-HC		1½ x 12½	27 x 312
TPP-AT-HC	✓	1½ x 20½	22 x 516

note: Pan dividers not standard on TPP models.

PIZZA PREP TABLES & PIZZA PREP TABLES ~SPEC3 SERIES~HGTP Solid Doors & Drawers~Heavy Gauge Top Package

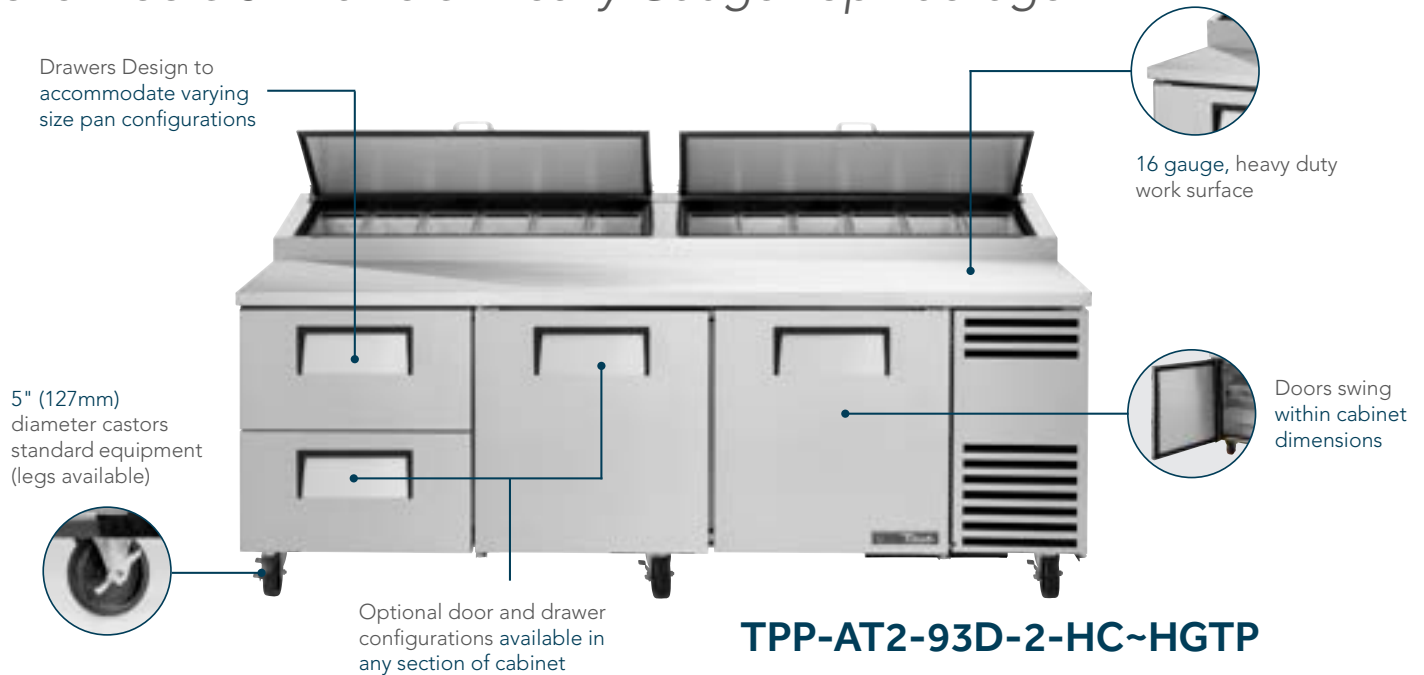

TPP-AT-44-HC-HGTP



TPP-AT-60D-2-HC-HGTP



TPP-67D-4-HC~SPEC3-HGTP



TPP-119-HC~SPEC3-HGTP

Features/Benefits

- Maintains cold 33°F to 41°F (0.5°C to 5°C) product temperatures.
- 16-gauge, heavy-duty work surface.
- All stainless steel front, top and ends.
- Corrosion resistant GalFan coated steel back.
- Interior - attractive, clear aluminum sides and top, coved corners and stainless steel floor.
- Recessed handles
- Adjustable, heavy-duty, PVC-coated wire shelves (not available in drawered sections).
- Standard full set of (1/3 size) 12-3/4" L x 6-1/4" W x 6" D (324mm x 159mm x 153mm) NSF approved, clear polycarbonate insert pans included in condiment rail.
- Drawered models (drawered section only) will accommodate up to two 8" (204mm) deep full size pans (12" L x 20" W x 8" D (305mm x 508mm x 204mm)) per drawer. (pans not included).
- Door models accommodate half bun tray rack; applies to only one door of TPP-60-AT-HC (18" (458mm) x 26" (661mm) sheet pan) - not included.
- Self-contained system.
- Front breathing.

- Work surface 36" (915mm) high.
- Rear bumpers.
- NSF/ANSI standard 7 compliant for open food product.
- Garnish rack and service shelf optional (service shelf is not available on TPP-119-AT's).

~SPEC3 Models have...

- All stainless steel front, countertop, sides, and back.
- Interior features stainless steel liner and stainless steel floor with coved corners.
- Heavy-duty top and 20 gauge door and drawer fronts.
- Heavy duty all metal working spec door/drawer handles.
- Door and drawer locks standard.
- Exterior digital temperature control and display.

True has 3 different widths of spacer bars to accommodate the needs of the end user:

Because plastic and stainless pan manufacturers have different dimensions, widths and sizes, our spacer bars will allow the end user to design almost any pan configuration. See accessory section for pan sizes and configuration.



TPP® PIZZA PREP TABLES~HEAVY GAUGE TOP PACKAGE

Model	Door/Drawers	# of Shelves	# of Pans (Top)	HP	Amps	Crated Weight lb. (kg.)	Cabinet Dimensions W D† H* (in)	Cabinet Dimensions W D† H* (mm)
WITH DOORS								
TPP-AT-44-HC~HGTP	1/0	2	6	¼	3.9	330 (150)	44½ x 33½ x 38½	1133 x 854 x 987
TPP-AT-60-HC~HGTP	2/0	4	8	¼	3.9	410 (186)	60¼ x 33½ x 38½	1530 x 854 x 987
TPP-AT-67-HC~HGTP	2/0	4	9	¼	3.9	455 (207)	67¾ x 33½ x 38½	1711 x 854 x 987
TPP-AT2-93-HC~HGTP	3/0	6	12	¾	7.1	600 (273)	93¾ x 33½ x 38½	2372 x 854 x 987
TPP-AT-119-HC~HGTP	4/0	8	15	¾	7.1	975 (443)	119¼ x 33½ x 38½	3029 x 854 x 987
WITH DRAWERS OR DOOR/DRAWER COMBO								
TPP-AT-44D-2-HC~HGTP	0/2	N/A	6	¼	3.9	330 (150)	44½ x 33½ x 38½	1133 x 854 x 987
TPP-AT-60D-2-HC~HGTP	1/2	2	8	¼	3.9	415 (189)	60¼ x 33½ x 38½	1530 x 854 x 987
TPP-AT-67D-2-HC~HGTP	1/2	N/A	9	¼	3.9	455 (207)	67¾ x 33½ x 38½	1711 x 854 x 987
TPP-AT-67D-4-HC~HGTP	0/4	2	9	¼	3.9	455 (207)	67¾ x 33½ x 38½	1711 x 854 x 987
TPP-AT2-93D-2-HC~HGTP	2/2	4	12	¾	7.1	600 (273)	93¾ x 33½ x 38½	2372 x 854 x 987
TPP-AT2-93D-4-HC~HGTP	1/4	2	12	¾	7.1	600 (273)	93¾ x 33½ x 38½	2372 x 854 x 987
TPP-AT2-93D-6-HC~HGTP	0/6	N/A	12	¾	7.1	600 (273)	93¾ x 33½ x 38½	2372 x 854 x 987
TPP-AT-119D-2-HC~HGTP	3/2	8	15	¾	7.1	975 (443)	119¼ x 33½ x 38½	3029 x 854 x 987
TPP-AT-119D-4-HC~HGTP	2/4	4	15	¾	7.1	975 (443)	119¼ x 33½ x 38½	3029 x 854 x 987
TPP-AT-119D-6-HC~HGTP	1/6	2	15	¾	7.1	975 (443)	119¼ x 33½ x 38½	3029 x 854 x 987
TPP-AT-119D-8-HC~HGTP	0/8	N/A	15	¾	7.1	975 (443)	119¼ x 33½ x 38½	3029 x 854 x 987

† Depth does not include 1" (26 mm) for rear bumpers. * Height does not include 5¾" (146 mm) for castors or 6" (153 mm) for optional legs.
 note: Door/drawer combination cabinets require customer to designate door/drawer orientation.

TPP® PIZZA PREP TABLES ~SPEC3 SERIES~HEAVY GAUGE TOP PACKAGE

Model	Door/Drawers	# of Shelves	# of Pans (Top)	HP	Amps	Crated Weight (kg.)	Cabinet Dimensions W D† H* (in)	Cabinet Dimensions W D† H* (mm)
WITH DOORS								
TPP-AT-44-HC~SPEC3~HGTP	1/0	2	6	¼	3.9	330 (150)	44½ x 33½ x 38½	1133 x 854 x 987
TPP-AT-60-HC~SPEC3~HGTP	2/0	4	8	¼	3.9	420 (191)	60¼ x 33½ x 38½	1530 x 854 x 987
TPP-AT-67-HC~SPEC3~HGTP	2/0	4	9	¼	3.9	415 (188)	67¾ x 33½ x 38½	1711 x 854 x 987
TPP-AT2-93-HC~SPEC3~HGTP	3/0	6	12	¾	7.1	600 (273)	93¾ x 33½ x 38½	2372 x 854 x 987
TPP-AT-119-HC~SPEC3~HGTP	4/0	8	15	¾	7.1	725 (329)	119¼ x 33½ x 38½	3029 x 854 x 987
WITH DRAWERS OR DOOR/DRAWER COMBO								
TPP-AT-44D-2-HC~SPEC3~HGTP	0/2	N/A	6	¼	3.9	330 (150)	44½ x 33½ x 38½	1133 x 854 x 987
TPP-AT-60D-2-HC~SPEC3~HGTP	1/2	2	8	¼	3.9	415 (189)	60¼ x 33½ x 38½	1530 x 854 x 987
TPP-AT-67D-4-HC~SPEC3~HGTP	0/4	N/A	9	¼	3.9	455 (207)	67¾ x 33½ x 38½	1711 x 854 x 987
TPP-AT2-93D-6-HC~SPEC3~HGTP	0/6	N/A	12	¾	7.1	600 (273)	93¾ x 33½ x 38½	2372 x 854 x 987
TPP-AT-119D-8-HC~SPEC3~HGTP	0/8	N/A	15	¾	7.1	975 (443)	119¼ x 33½ x 38½	3029 x 854 x 987

† Depth does not include 1" (26 mm) for rear bumpers. * Height does not include 5¾" (146 mm) for castors or 6" (153 mm) for optional legs.
 note: Door/drawer combination cabinets require customer to designate door/drawer orientation.



UNDERCOUNTER & WORKTOP REFRIGERATION



The kitchen worktop is where your creations come to life. When it's time to prep your customer's favorites, you can rely on True to streamline your operations. Our variety of model options are flexible to meet your needs – whether you need a unit that slides under an existing countertop, or you're in need of a functional work surface for smooth operations.





UNDERCOUNTER REFRIGERATION

The undercounter series offers exceptional refrigeration that slides easily under existing countertops for space efficiency, or provides a functional work surface for easy food preparation and reliable cold storage.



UNDERCOUNTER REFRIGERATORS

Solid & Glass Doors, Solid Drawers



TUC-48-HC



TUC-27-HC-FGD01



TUC-27-HC



TUC-48D-4-HC



TUC-72-HC

Features/Benefits

- Refrigerators maintain cold 33°F to 38°F (0.5°C to 3.3°C) product temperatures.
- All stainless steel front, top and sides.
- Corrosion resistant GalFan coated steel back.
- Interior - attractive, clear aluminum sides and top, coved corners and stainless steel floor.
- Recessed handles
- Adjustable, heavy-duty, PVC-coated wire shelves (not available in drawered models).
- Work surface 36" (915mm) high.
- Low profile models (31-7/8" (810mm) work surface height) upcharge applies or ADA compliant with 34" (864mm) work surface height available; no charge. (models -27, -36, -48, -60, -72).
- All production of True models comply with NSF/ANSI standard 7.
- Self-contained system.

Glass Door Model have...

- Energy efficient, "Low-E", thermal insulated glass doors on refrigerator models (triple pane thermal insulated glass on freezer models).
- Extruded, aluminum door frames.
- Each door fitted with 12" (305 mm) long extruded aluminum handle.
- LED interior lighting provides more even lighting throughout the cabinet. Safety shielded.

Drawer Models have...

- Accommodates one 12" L x 20" W x 6" D (305mm x 508mm x 153mm) full size pan or two 1/2 pans or three 1/3 pans per drawer. (48" (1,220mm) models accommodate one 12" L x 18" W x 6" D (305mm x 408mm x 153mm) food storage box or one 1/3 size and one 1/2 size pan per drawer; not included).
- Door/drawer combination models require customer to designate door/drawer orientation.



TUC® UNDERCOUNTER REFRIGERATORS

Model	Door/Drawers	# of Shelves	HP	Amps	Crated Weight lb. (kg.)	Cabinet Dimensions W D† H* (in)	Cabinet Dimensions W D† H* (mm)
SOLID DOORS							
TUC-24-HC	1/0	2	1/6	2.0	155 (71)	24 1/8 x 24 7/8 x 31 1/8	613 x 630 x 802
TUC-27-HC	1/0	2	1/6	2.0	195 (89)	27 5/8 x 30 1/8 x 29 3/4	702 x 766 x 756
TUC-36-HC	2/0	4	1/6	2.0	235 (107)	36 3/8 x 30 1/8 x 29 3/4	924 x 766 x 756
TUC-48-HC	2/0	4	1/5	2.0	260 (118)	48 3/8 x 30 1/8 x 29 3/4	1229 x 766 x 756
TUC-60-HC	2/0	4	1/4	4.0	320 (146)	60 3/8 x 30 1/8 x 29 3/4	1534 x 766 x 756
TUC-72-HC	3/0	6	1/4	4.0	380 (173)	72 3/8 x 30 1/8 x 29 3/4	1839 x 766 x 756
GLASS DOORS							
TUC-24G-HC~FGD01	1/0	2	1/6	2.0	165 (75)	24 x 24 3/4 x 31 1/8	610 x 629 x 804
TUC-27G-HC~FGD01	1/0	2	1/6	2.0	205 (93)	27 5/8 x 30 1/8 x 29 3/4	702 x 766 x 756
TUC-48G-HC~FGD01	2/0	4	1/5	3.0	285 (130)	48 3/8 x 30 1/8 x 29 3/4	1229 x 766 x 756
TUC-60G-HC~FGD01	2/0	4	1/4	4.0	350 (159)	60 3/8 x 30 1/8 x 29 3/4	1534 x 766 x 756
WITH DRAWERS OR DOOR/DRAWER COMBO							
TUC-27D-2-HC	0/2	N/A	1/6	2.0	225 (103)	27 5/8 x 30 1/8 x 29 3/4	702 x 766 x 756
TUC-48D-2-HC	1/2	2	1/5	3.0	310 (141)	48 3/8 x 30 1/8 x 29 3/4	1229 x 766 x 756
TUC-48D-4-HC	0/4	N/A	1/5	3.0	330 (150)	48 3/8 x 30 1/8 x 29 3/4	1229 x 766 x 756
TUC-60D-2-HC	1/2	2	1/4	4.0	445 (202)	60 3/8 x 30 1/8 x 29 3/4	1534 x 766 x 756
TUC-60D-4-HC	0/4	N/A	1/4	4.0	400 (182)	60 3/8 x 30 1/8 x 29 3/4	1534 x 766 x 756

† Depth does not include 1" (26mm) for rear bumpers and 1/2" (13mm) for glass door handles.

* Height does not include 6 1/4" (159mm) for castors or 6" (153mm) for optional legs. (Excludes TUC-24-HC)

note: Door/drawer combination cabinets require customer to designate door/drawer orientation.

TFT™ UNDERCOUNTER FLAT TOP REFRIGERATORS

Model	Door/Drawers	# of Shelves	HP	Amps	Crated Weight lb. (kg.)	Cabinet Dimensions W D† H* (in)	Cabinet Dimensions W D† H* (mm)
SOLID DOORS							
TFT-32-HC	1/0	2	1/5	1.6	260 (118)	32 1/2 x 31 1/2 x 35 7/8	816 x 800 x 911
WITH DRAWERS							
TFT-32D-2-HC	0/2	N/A	1/5	1.6	315 (143)	32 1/2 x 31 1/2 x 35 7/8	816 x 800 x 911

Environmentally friendly R290 hydrocarbon refrigeration system for the best in food preservation.



DEEP UNDERCOUNTER REFRIGERATORS

Solid Doors & Drawers

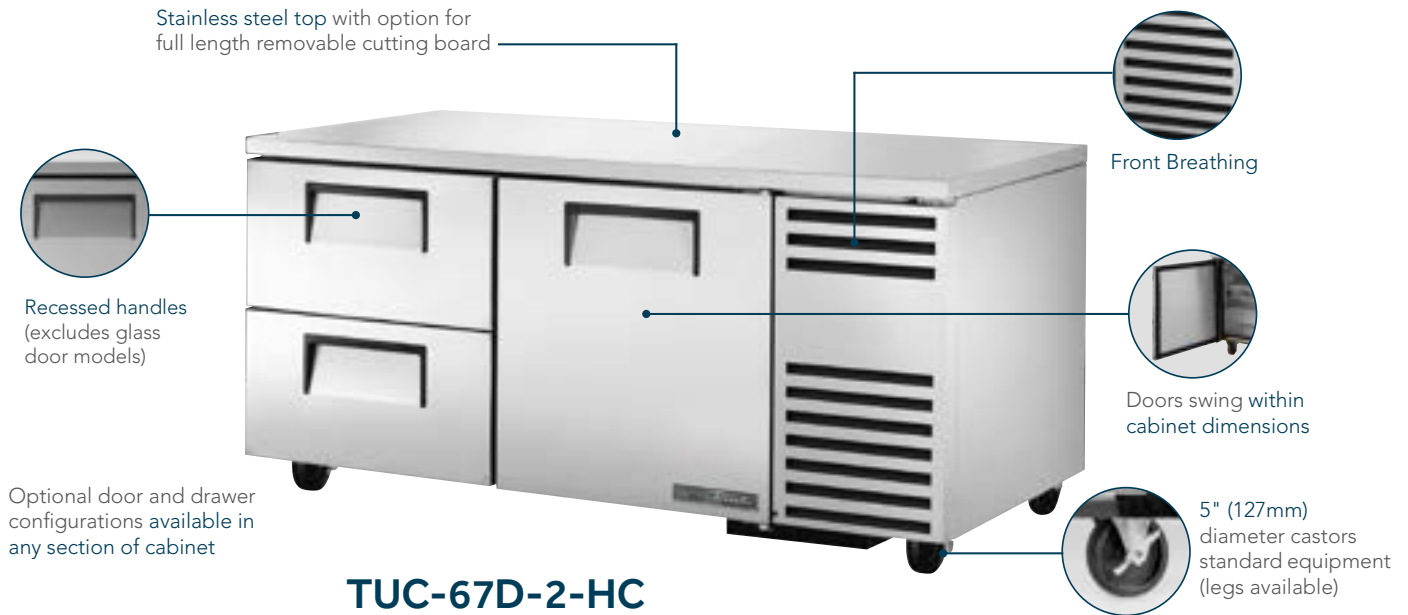

TUC-44-HC



TUC-60-32D-2-HC



TUC-67-HC



TUC-93D-4-HC

Features/Benefits

- Refrigerators maintain cold 33°F to 38°F (0.5°C to 3.3°C) product temperatures.
 - Features the combined advantage of convenient undercounter placement with deeper refrigerated storage.
 - Easily slides under counters, maximizes space for refrigerated food storage in fast food line-up.
 - Balanced circular airflow for uniform product cooling.
 - All stainless steel front, top and sides.
 - Corrosion resistant GalFan coated steel back.
 - Interior - attractive, clear aluminum sides and top, coved corners and stainless steel floor.
 - Work surface 36" (915mm) high.
 - Adjustable, heavy-duty, PVC-coated wire shelves (not available in drawered models).
 - Front breathing.
 - Door models accommodate half bun tray rack; applies to only one door of TUC-60-32 (18" x 26" sheet pan (458mm x 661mm)) - not included.
 - All production of True models comply with NSF/ANSI standard 7.
 - Additional castor and leg options available.
 - Self-contained system.
- Drawer Models have...**
- Accommodates one 12" L x 20" W x 8" D (305mm x 508mm x 204mm) full size pan or four 1/2 pans or six 1/3 pans per drawer. Pans not included.
 - Door/drawer combination models require customer to designate door/drawer orientation.



TUC® DEEP UNDERCOUNTER REFRIGERATORS

Model	Door/Drawers	# of Shelves	HP	Amps	Crated Weight lb. (kg.)	Cabinet Dimensions W D† H* (in)	Cabinet Dimensions W D† H* (mm)
SOLID DOORS							
TUC-44-HC	1/0	2	1/10	1.7	285 (123)	44 ⁷ / ₈ x 32 ¹ / ₄ x 29 ³ / ₄	1138 x 818 x 756
TUC-60-32-HC	2/0	4	1/10	1.7	415 (189)	60 ¹ / ₄ x 32 ¹ / ₄ x 29 ³ / ₄	1531 x 818 x 756
TUC-67-HC	2/0	4	1/10	1.7	410 (186)	67 ¹ / ₄ x 32 ¹ / ₄ x 29 ³ / ₄	1709 x 818 x 756
TUC-93-HC	3/0	6	1/5	2.2	515 (234)	93 ¹ / ₄ x 32 ¹ / ₄ x 29 ³ / ₄	2369 x 818 x 756
WITH DRAWERS OR DOOR/DRAWER COMBO							
TUC-44D-2-HC	0/2	N/A	1/10	1.7	285 (130)	44 ⁷ / ₈ x 32 ¹ / ₄ x 29 ³ / ₄	1138 x 818 x 756
TUC-60-32D-2-HC	1/2	2	1/10	1.7	345 (156)	60 ¹ / ₄ x 32 ¹ / ₄ x 29 ³ / ₄	1531 x 818 x 756
TUC-67D-2-HC	1/2	2	1/10	1.7	485 (220)	67 ¹ / ₄ x 32 ¹ / ₄ x 29 ³ / ₄	1708 x 818 x 756
TUC-67D-4-HC	0/4	N/A	1/10	1.7	390 (177)	67 ¹ / ₄ x 32 ¹ / ₄ x 29 ³ / ₄	1708 x 818 x 756
TUC-93D-2-HC	2/2	4	1/5	2.2	640 (291)	93 ¹ / ₄ x 32 ¹ / ₄ x 29 ³ / ₄	2369 x 818 x 756
TUC-93D-4-HC	1/4	2	1/5	2.2	640 (291)	93 ¹ / ₄ x 32 ¹ / ₄ x 29 ³ / ₄	2369 x 818 x 756
TUC-93D-6-HC	0/6	N/A	1/5	2.2	550 (250)	93 ¹ / ₄ x 32 ¹ / ₄ x 29 ³ / ₄	2369 x 818 x 756

† Depth does not include 1" (26mm) for rear bumpers or 1/4" (7mm) for front bumper.

* Height does not include 6 1/4" (159mm) for castors or 6" (153mm) for optional legs.

note: Door/drawer combination cabinets require customer to designate door/drawer orientation.

Environmentally friendly R290 hydrocarbon refrigeration system for the best in food preservation.



UNDERCOUNTER REFRIGERATORS ~SPEC3 SERIES

Solid & Glass Doors, Solid Drawers

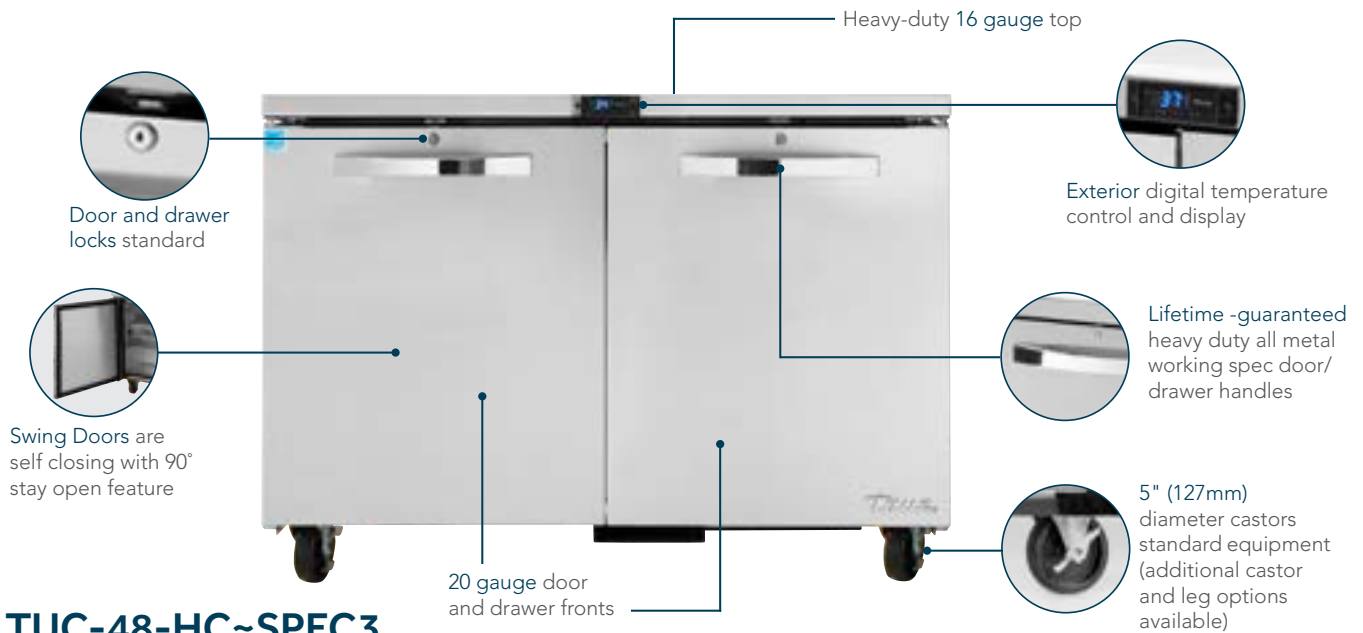

TUC-48-HC~SPEC3



TUC-27-HC~SPEC3



TUC-48G-HC~SPEC3



TUC-60-HC~SPEC3



TUC-60D-4-HC~SPEC3

Features/Benefits

- Refrigerators maintain cold 33°F to 38°F (0.5°C to 3.3°C) product temperatures.
- All stainless steel front, countertop, sides and back.
- Interior features stainless steel liner and stainless steel floor with coved corners.
- Adjustable, heavy-duty, PVC-coated wire shelves (not available in drawer models).
- Doors swing within cabinet dimensions.
- Work surface 36" (915mm) high.
- Low profile models (31-7/8" (810mm) work surface height) upcharge applies or ADA compliant with 34" (864mm) work surface height available; no charge. (models -27, -36, -48, -60, -72).
- All production of True models comply with NSF/ANSI standard 7.
- Self-contained system.

Glass Door Model have...

- Energy efficient, "Low-E", double paned thermal insulated glass doors on refrigerator models (triple paned thermal insulated glass doors on freezer models).
- Extruded, aluminum door frames.
- LED interior lighting provides more even lighting throughout the cabinet. Safety shielded.

Drawer Models have...

- Standard depth models accommodate one 12" L x 20" W x 8" D (305mm x 508mm x 204mm) full size pan or four 1/2 pans or six 1/3 pans per drawer. Pans not included.
- Door/drawer combination models require customer to designate door/drawer orientation.



TUC® UNDERCOUNTER REFRIGERATORS ~SPEC3 SERIES

Model	Door/Drawers	# of Shelves	HP	Amps	Crated Weight lb. (kg.)	Cabinet Dimensions W D† H* (in)	Cabinet Dimensions W D† H* (mm)
SOLID DOORS							
TUC-24-HC~SPEC3	1/0	2	1/6	2.0	155 (71)	24 x 24¾ x 31½	610 x 629 x 804
TUC-27-HC~SPEC3	1/0	2	1/6	2.0	185 (84)	27½ x 29½ x 29¾	702 x 740 x 756
TUC-36-HC~SPEC3	2/0	4	1/6	2.0	240 (109)	36½ x 29½ x 29¾	922 x 740 x 756
TUC-48-HC~SPEC3	2/0	4	1/5	2.0	305 (139)	48½ x 29½ x 29¾	1229 x 740 x 756
TUC-60-HC~SPEC3	2/0	4	1/4	4.0	355 (162)	60½ x 29½ x 29¾	1534 x 740 x 756
TUC-72-HC~SPEC3	3/0	6	1/4	4.0	380 (173)	72½ x 29½ x 29¾	1839 x 740 x 756
GLASS DOORS							
TUC-27G-HC~SPEC3	1/0	2	1/6	2.0	205 (93)	27½ x 29½ x 29¾	702 x 740 x 756
TUC-48G-HC~SPEC3	2/0	4	1/5	3.0	285 (130)	48½ x 29½ x 29¾	1227 x 740 x 756
TUC-60G-HC~SPEC3	2/0	4	1/4	4.0	350 (159)	60½ x 29½ x 29¾	1534 x 740 x 756
WITH DRAWERS OR DOOR/DRAWER COMBO							
TUC-27D-2-HC~SPEC3	0/2	N/A	1/6	2.0	225 (103)	27½ x 29½ x 29¾	702 x 740 x 756
TUC-48D-2-HC~SPEC3	1/2	2	1/5	3.0	310 (141)	48½ x 29½ x 29¾	1229 x 740 x 756
TUC-48D-4-HC~SPEC3	0/4	N/A	1/5	3.0	330 (150)	48½ x 29½ x 29¾	1229 x 740 x 756
TUC-60D-2-HC~SPEC3	1/2	2	1/4	4.0	445(202)	60½ x 29½ x 29¾	1534 x 740 x 756
TUC-60D-4-HC~SPEC3	0/4	N/A	1/4	4.0	400 (182)	60½ x 29½ x 29¾	1534 x 740 x 756

† Depth does not include 1½" (39mm) for door handles.

† Depth does not include 1" (26mm) for rear bumpers.

* Height does not include 6¼" (159mm) for castors or 6" (153mm) for optional legs. (Excludes TUC-24-HC~SPEC3)

note: Door/drawer combination cabinets require customer to designate door/drawer orientation.

Environmentally friendly R290 hydrocarbon refrigeration system for the best in food preservation.



Undercounter | TUC[®] Deep~SPEC3

UNDERCOUNTER DEEP REFRIGERATORS ~SPEC3

Solid Doors & Drawers



TUC-67D-2-HC~SPEC3



TUC-44D-2-HC~SPEC3



TUC-60-32D-2-HC~SPEC3



TUC-67-HC~SPEC3



TUC-93D-2-HC~SPEC3

Features/Benefits

- Refrigerators maintain cold 33°F to 38°F (0.5°C to 3.3°C) product temperatures..
 - Features the combined advantage of convenient undercounter placement with deeper refrigerated storage.
 - All stainless steel front, countertop, sides and back.
 - Interior features stainless steel liner and stainless steel floor with coved corners.
 - Adjustable, heavy-duty, PVC-coated wire shelves (not available in drawered models).
 - Doors swing within cabinet dimensions.
 - Work surface 36" (915mm) high.
 - Accommodates half bun tray rack; applies to only one door of TUC-60-32 (18" x 26" sheet pan (458mm x 661mm)) - not included.
 - ADA compliant with 34" (864mm) work surface height available; no charge.
 - All production of True models comply with NSF/ANSI standard 7.
 - Self-contained system.
- Drawer Models have...**
- Accommodates one 12" L x 20" W x 8" D (305mm x 508mm x 204mm) full size pan or four 1/2 pans or six 1/3 pans per drawer. Pans not included.
 - Door/drawer combination models require customer to designate door/drawer orientation.



TUC® DEEP UNDERCOUNTER REFRIGERATORS ~SPEC3 SERIES

Model	Door/Drawers	# of Shelves	HP	Amps	Crated Weight lb. (kg.)	Cabinet Dimensions W D† H* (in)	Cabinet Dimensions W D† H* (mm)
SOLID DOORS							
TUC-44-HC~SPEC3	1/0	2	1/10	1.7	285 (130)	44 7/8 x 32 1/4 x 29 3/4	1138 x 818 x 756
TUC-60-32-HC~SPEC3	2/0	4	1/10	1.7	415 (189)	60 1/4 x 32 1/4 x 29 3/4	1531 x 818 x 756
TUC-67-HC~SPEC3	2/0	4	1/10	1.7	410 (186)	67 1/4 x 32 1/4 x 29 3/4	1709 x 818 x 756
TUC-93-HC~SPEC3	3/0	6	1/5	2.2	515 (234)	93 1/4 x 32 1/4 x 29 3/4	2369 x 818 x 756
WITH DRAWERS OR DOOR/DRAWER COMBO							
TUC-44D-2-HC~SPEC3	0/2	N/A	1/10	1.7	270 (123)	44 7/8 x 32 1/4 x 29 3/4	1138 x 818 x 756
TUC-60-32D-2-HC~SPEC3	1/2	2	1/10	1.7	345 (156)	60 1/4 x 32 1/4 x 29 3/4	1531 x 818 x 756
TUC-67D-2-HC~SPEC3	1/2	2	1/10	1.7	430 (193)	67 1/4 x 32 1/4 x 29 3/4	1709 x 818 x 756
TUC-67D-4-HC~SPEC3	0/4	N/A	1/10	1.7	390 (177)	67 1/4 x 32 1/4 x 29 3/4	1709 x 818 x 756
TUC-93D-2-HC~SPEC3	2/2	4	1/5	2.2	640 (291)	93 1/4 x 32 1/4 x 29 3/4	2369 x 818 x 756
TUC-93D-4-HC~SPEC3	1/4	2	1/5	2.2	640 (291)	93 1/4 x 32 1/4 x 29 3/4	2369 x 818 x 756
TUC-93D-6-HC~SPEC3	0/6	N/A	1/5	2.2	685 (311)	93 1/4 x 32 1/4 x 29 3/4	2369 x 818 x 756

† Depth does not include 1" (26mm) for rear bumpers or 1/4"(7mm) for front bumper.

* Height does not include 6 1/4" (159mm) for castors or 6"(153mm) for optional legs.

note: Door/drawer combination cabinets require customer to designate door/drawer orientation.

Environmentally friendly R290 hydrocarbon refrigeration system for the best in food preservation.



UNDERCOUNTER FREEZERS

Solid Doors & Drawers



TUC-24F-HC



TUC-27F-D-2-HC



TUC-48F-D-4-HC



TUC-60F-HC

Features/Benefits

- Freezers maintain -10°F (-23.3°C) product temperatures.
- Automatic defrost system on freezer models time-initiated, time-terminated.
- All stainless steel front, top and sides.
- Corrosion resistant GalFan coated steel back.
- Interior - attractive, NSF/ANSI standard 7 approved, clear aluminum sides and top, coved corners and stainless steel floor.
- Recessed handles
- Adjustable, heavy-duty, PVC-coated wire shelves (not available in drawer models).
- Work surface 36" (915mm) high.
- Low profile models (31-7/8" (810mm) work surface height) upcharge applies or ADA compliant with 34" (864mm) work surface height available; no charge. (models -27, -36, -48, -60, -72).
- Self-contained system.

FLX models...

- Easily converts from freezer to refrigerator with the flip of a switch.

Glass Door Model have...

- Energy efficient, "Low-E", double paned thermal insulated glass doors on refrigerator models (triple paned thermal insulated glass on freezer models).
- Extruded, aluminum door frames.
- Each door fitted with 12" (305 mm) long extruded aluminum handle.
- LED interior lighting provides more even lighting throughout the cabinet. Safety shielded.

Drawer Models have...

- Accommodates one 12" L x 20" W x 6" D (305mm x 508mm x 153mm) full size pan or two 1/2 pans or three 1/3 pans per drawer. (48" (1,220mm) models accommodate one 12" L x 18" W x 6" D (305mm x 408mm x 153mm) food storage box or one 1/3 size and one 1/2 size pan per drawer; not included).
- Door/drawer combination models require customer to designate door/drawer orientation.



TUC® UNDERCOUNTER FREEZERS

Model	Door/Drawers	# of Shelves	HP	Amps	Crated Weight lb. (kg.)	Cabinet Dimensions W D† H* (in)	Cabinet Dimensions W D† H* (mm)
SOLID DOORS							
TUC-24F-HC	1/0	2	¼	2.3	165 (75)	24 x 24¾ x 31½	610 x 629 x 804
TUC-27F-HC	1/0	2	¼	2.3	190 (87)	27½ x 30½ x 29¾	702 x 766 x 756
TUC-48F-HC	2/0	4	½	3.2	275 (125)	48¾ x 30½ x 29¾	1229 x 766 x 756
TUC-60F-HC	2/0	4	½	4.8	335 (152)	60¾ x 30½ x 29¾	1534 x 766 x 756
WITH DRAWERS							
TUC-27F-D-2-HC	0/2	N/A	¼	2.3	220 (100)	27½ x 30½ x 29¾	702 x 766 x 756
TUC-48F-D-4-HC	0/4	N/A	½	3.2	325 (148)	48¾ x 30½ x 29¾	1229 x 766 x 756

† Depth does not include 1" (26mm) for rear bumpers.

* Height does not include 6¼"(159mm) for castors or 6"(153mm) for optional legs. (Excludes TUC-24-HC)

note: Door/drawer combination cabinets require customer to designate door/drawer orientation.

FLX UNDERCOUNTER CONVERTIBLE REFRIGERATOR/FREEZER

Model	Doors/Drawers	# of Shelves	HP	Amps	Crated Weight lb. (kg.)	Cabinet Dimensions W D† H* (in)	Cabinet Dimensions W D† H* (mm)
SOLID DOORS							
TUC-27F-FLX-HC	1/0	2	¼	2.3	190 (87)	27½ x 30½ x 29¾	702 x 766 x 756

† Depth does not include 1" (26mm) for rear bumpers.

* Height does not include 6¼" (159mm) for castors or 6" (153mm) for optional legs.



Environmentally friendly R290 hydrocarbon refrigeration system for the best in food preservation.



DEEP UNDERCOUNTER FREEZERS

Solid Doors



TUC-44F-HC



TUC-67F-HC

Features/Benefits

- Freezers maintain -10°F (-23.3°C) product temperatures.
 - Features the combined advantage of convenient undercounter placement with deeper refrigerated storage.
 - Easily slides under counters, maximizes space for refrigerated food storage in fast food line-up.
 - Automatic defrost system on freezer models time-initiated, time-terminated.
 - 360° circular airflow for uniform product cooling.
 - All stainless steel front, top and sides.
 - Corrosion resistant GalFan coated steel back.
 - Interior - attractive, clear aluminum sides and top, coved corners and stainless steel floor.
 - Work surface 36" (915mm) high.
 - Adjustable, heavy-duty, PVC-coated wire shelves (not available in drawer models).
 - Front breathing.
 - Door models accommodate half bun tray rack; applies to only one door of TUC-60-32 (18" x 26" (458mm x 661mm) sheet pan) - not included.
 - All production of True models comply with NSF/ANSI standard 7.
 - Available with optional 3" (77mm) diameter castors.
 - Self-contained system.
- Drawer Models have...**
- Accommodates one 12" L x 20" W x 8" D (305mm x 508mm x 204mm) full size pan or four 1/2 pans or six 1/3 pans per drawer. Pans not included.
 - Door/drawer combination models require customer to designate door/drawer orientation.



TUC® DEEP UNDERCOUNTER FREEZERS

Model	Door/Drawers	# of Shelves	HP	Amps	Crated Weight lb. (kg.)	Cabinet Dimensions W D† H* (in)	Cabinet Dimensions W D† H* (mm)
SOLID DOORS							
TUC-44F-HC	1/0	2	½	5.8	285 (130)	44 ⁷ / ₈ x 32 ¹ / ₄ x 29 ³ / ₄	1138 x 820 x 756
TUC-60-32F-HC	2/0	4	½	5.8	415 (189)	60 ¹ / ₄ x 32 ¹ / ₄ x 29 ³ / ₄	1531 x 820 x 756
TUC-67F-HC	2/0	4	½	5.8	400 (182)	67 ¹ / ₄ x 32 ¹ / ₄ x 29 ³ / ₄	1709 x 820 x 756

† Depth does not include 1" (26mm) for rear bumpers or ¼"(7mm) for front bumper.

* Height does not include 6¼"(159mm) for castors or 6" (153mm) for optional legs.

note: Door/drawer combination cabinets require customer to designate door/drawer orientation.

Environmentally friendly R290 hydrocarbon refrigeration system for the best in food preservation.



UNDERCOUNTER FREEZERS ~SPEC3 SERIES

Solid Doors & Drawers



TUC-48F-HC~SPEC3



TUC-27F-HC~SPEC3



TUC-27F-D-2-HC~SPEC3



TUC-48F-D-4-HC~SPEC3



TUC-60F-HC~SPEC3

Features/Benefits

- Freezers maintain -10°F (-23.3°C) product temperatures.
- Automatic defrost system on freezer models time-initiated, time-terminated.
- All stainless steel front, countertop, sides and back.
- Interior features stainless steel liner and stainless steel floor with coved corners.
- Adjustable, heavy-duty, PVC-coated wire shelves (not available in drawer models).
- Doors swing within cabinet dimensions.
- Work surface 36" (915mm) high.
- Low profile models (31-7/8" (810mm) work surface height) upcharge applies or ADA compliant with 34" (864mm) work surface height available; no charge. (models -27, -36, -48, -60, -72).
- All production of True models comply with NSF/ANSI standard 7.
- Self-contained system.

Glass Door Model have...

- Energy efficient, "Low-E", double paned thermal insulated glass doors on refrigerator models (triple pane thermal insulated glass on freezer models).
- Extruded, aluminum door frames.
- LED interior lighting provides more even lighting throughout the cabinet. Safety shielded.

Drawer Models have...

- Standard depth models accommodate one 12" L x 20" W x 8" D (305mm x 508mm x 204mm) full size pan or four 1/2 pans or six 1/3 pans per drawer. Pans not included.
- Door/drawer combination models require customer to designate door/drawer orientation.



TUC® UNDERCOUNTER FREEZERS ~SPEC3 SERIES

Model	Door/Drawers	# of Shelves	HP	Amps	Crated Weight lb. (kg.)	Cabinet Dimensions W D† H* (in)	Cabinet Dimensions W D† H* (mm)
SOLID DOORS							
TUC-27F-HC~SPEC3	1/0	2	¼	2.3	210 (96)	27½ x 29½ x 29¾	702 x 740 x 756
TUC-48F-HC~SPEC3	2/0	4	⅓	3.2	275 (125)	48¾ x 29½ x 29¾	1229 x 740 x 756
TUC-60F-HC~SPEC3	2/0	4	½	4.8	335 (152)	60¾ x 29½ x 29¾	1534 x 740 x 756
WITH DRAWERS							
TUC-27F-D-2-HC~SPEC3	0/2	N/A	¼	2.3	220 (100)	27½ x 29½ x 29¾	700 x 740 x 756
TUC-48F-D-4-HC~SPEC3	0/4	N/A	⅓	3.2	325 (148)	48¾ x 29½ x 29¾	1229 x 740 x 756

† Depth does not include 1¾" (45mm) for door handles.

‡ Depth does not include 1" (26mm) for rear bumpers or ¼" (7mm) for front bumper.

* Height does not include 6¼" (159mm) for castors or 6" (153mm) for optional legs.

note: Door/drawer combination cabinets require customer to designate door/drawer orientation.

Environmentally friendly R290 hydrocarbon refrigeration system for the best in food preservation.



Undercounter | TUC® Deep~SPEC3

UNDERCOUNTER DEEP FREEZERS ~SPEC3

Solid Doors



TUC-44F-HC~SPEC3



TUC-67F-HC~SPEC3

Features/Benefits

- Freezers maintain -10°F (-23.3°C) product temperatures.
- Automatic defrost system on freezer models time-initiated, time-terminated.
- Features the combined advantage of convenient undercounter placement with deeper refrigerated storage.
- All stainless steel front, countertop, sides and back.
- Interior features stainless steel liner and stainless steel floor with coved corners.
- Adjustable, heavy-duty, PVC-coated wire shelves (not available in drawer models).
- Doors swing within cabinet dimensions.
- Work surface 36" (915mm) high.

- Accommodates half bun tray rack; applies to only one door of TUC-60-32 (18" x 26" (458mm x 661mm) sheet pan) - not included.
- ADA compliant with 34" (864mm) work surface height available; no charge.
- All production of True models comply with NSF/ANSI standard 7.
- Self-contained system.

Drawer Models have...

- Accommodates one 12" L x 20" W x 8" D (305mm x 508mm x 204mm) full size pan or four 1/2 pans or six 1/3 pans per drawer. Pans not included.
- Door/drawer combination models require customer to designate door/drawer orientation.



TUC® DEEP UNDERCOUNTER FREEZERS ~SPEC3 SERIES

Model	Door/Drawers	# of Shelves	HP	Amps	Crated Weight lb. (kg.)	Cabinet Dimensions W D† H* (in)	Cabinet Dimensions W D† H* (mm)
SOLID DOORS							
TUC-44F-HC~SPEC3	1/0	2	½	5.8	285 (130)	44 ⁷ / ₈ x 32 ¹ / ₄ x 29 ³ / ₄	1138 x 818 x 765
TUC-60-32F-HC~SPEC3	2/0	4	½	5.8	415 (189)	60 ¹ / ₄ x 32 ¹ / ₄ x 29 ³ / ₄	1531 x 818 x 765
TUC-67F-HC~SPEC3	2/0	4	½	5.8	430 (196)	67 ¹ / ₄ x 32 ¹ / ₄ x 29 ³ / ₄	1709 x 818 x 765

† Depth does not include 1" (26mm) for rear bumpers or ¼" (7mm) for front bumper.

* Height does not include 6¼" (159mm) for castors or 6" (153mm) for optional legs.

note: Door/drawer combination cabinets require customer to designate door/drawer orientation.

Environmentally friendly R290 hydrocarbon refrigeration system for the best in food preservation.



Undercounter | TUC® (ADA & LP)

AMERICAN DISABILITY ACT (ADA) COMPLIANT & LOW PROFILE (LP) PACKAGES

Solid Doors & Drawers



ADA models feature 3" (77mm) diameter castors



TUC-27-HC



LP models feature 1-½" (39mm) diameter, dual swivel castors



TUC-27-HC

Features/Benefits

ADA Models...

- True undercounter units are designed to accommodate American Disabilities Act (ADA) requirements.
- ADA Compliant models have 3" (127mm) castors
- ADA Compliant models have 34" (864mm) counter heights.

LP Models...

- "Low Profile" models are designed to slide easily under custom built countertops.
- Low profile models have 1-1/2" (39mm) castors
- Low profile models have 31-7/8" (810mm) work surface heights.

True Undercounter Units Are Designed To Accommodate American Disabilities Act (ADA) Requirements.

PLAN VIEW COMPARISON

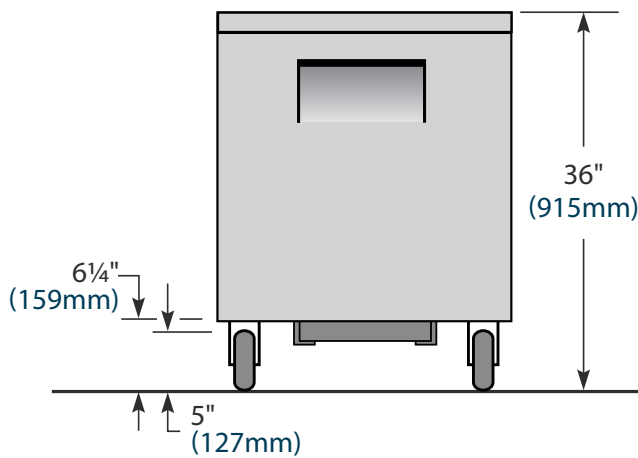

Standard

36" (915mm) Height

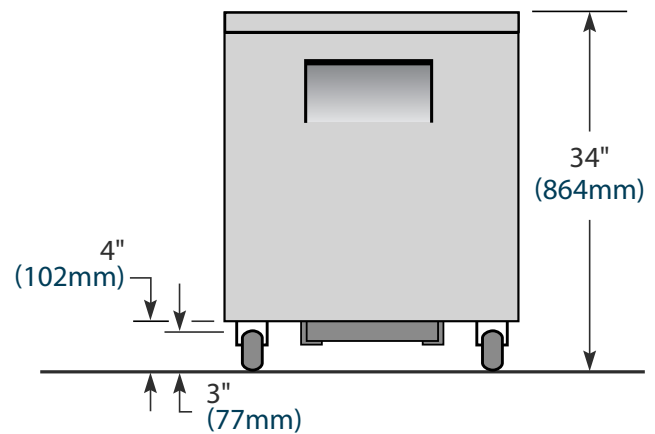

ADA Compliant

34" (864mm) Height

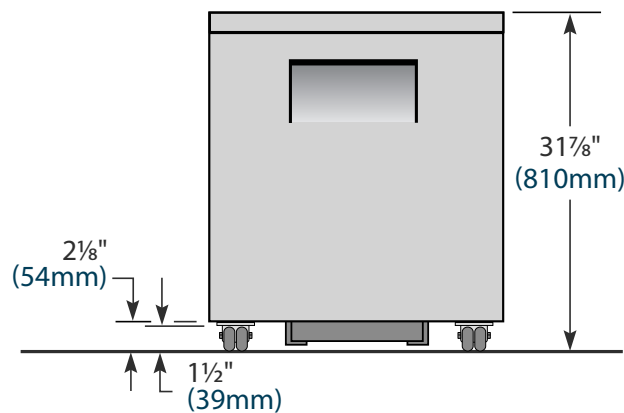

Low Profile

31-7/8" (810mm) Height



WORKTOP REFRIGERATION

Worktop refrigerators provide a functional work surface as well as a one-piece formed construction stainless backsplash and 360° circular airflow for the most efficient and uniform product cooling.



WORKTOP REFRIGERATORS

Solid Doors & Drawers



TWT-27D-2-HC



TWT-27F-HC



TWT-60D-4-HC



TWT-72-HC

Features/Benefits

- Refrigerators maintain cold 33°F to 38°F (0.5°C to 3.3°C) product temperatures.
 - All stainless steel front, top and sides.
 - Corrosion resistant GalFan coated steel back.
 - Interior - attractive, clear aluminum sides and top, coved corners and stainless steel floor.
 - One piece formed construction backsplash prevents bacteria and food particles from being trapped underneath as with other two piece worktop units
 - Recessed handles
 - Adjustable, heavy-duty, PVC-coated wire shelves (not available in drawered models).
 - Work surface 36" (915mm) high.
 - Swing doors are self-closing with 90° stay open feature.
 - ADA compliant with 34" (864mm) work surface height available; no charge. (models -27, -36, -48, -60, -72).
 - All production of True models comply with NSF/ANSI standard 7.
 - Self-contained system.
- Drawer Models have...**
- Accommodates one 12"L x 20"W x 6"D (305mm x 508mm x 153mm) full size pan or two 1/2 pans or three 1/3 pans per drawer. (48" (1,220mm) models accommodate one 12"L x 18"W x 6"D (305mm x 408mm x 153mm) food storage box or one 1/3 size and one 1/2 size pan per drawer; not included).
 - Door/drawer combination models require customer to designate door/drawer orientation.



TWT™ WORKTOP REFRIGERATORS

Model	Door/Drawers	# of Shelves	HP	Amps	Crated Weight lb. (kg.)	Cabinet Dimensions W D† H* (in)	Cabinet Dimensions W D† H* (mm)
SOLID DOORS							
TWT-27-HC	1/0	2	1/6	2.0	195 (89)	27 ³ / ₈ x 30 ¹ / ₈ x 33 ³ / ₈	702 x 766 x 848
TWT-36-HC	2/0	4	1/6	2.0	240 (109)	36 ³ / ₈ x 30 ¹ / ₈ x 33 ³ / ₈	924 x 766 x 848
TWT-48-HC	2/0	4	1/5	2.0	280 (128)	48 ³ / ₈ x 30 ¹ / ₈ x 33 ³ / ₈	1229 x 766 x 848
TWT-60-HC	2/0	4	1/4	4.0	345 (157)	60 ³ / ₈ x 30 ¹ / ₈ x 33 ³ / ₈	1534 x 766 x 848
TWT-72-HC	3/0	6	1/4	4.0	405 (184)	72 ³ / ₈ x 30 ¹ / ₈ x 33 ³ / ₈	1839 x 766 x 848
WITH DRAWERS OR DOOR/DRAWER COMBO							
TWT-27D-2-HC	0/2	N/A	1/6	2.0	215 (98)	27 ³ / ₈ x 30 ¹ / ₈ x 33 ³ / ₈	702 x 766 x 848
TWT-48D-2-HC	1/2	2	1/5	3.0	330 (150)	48 ³ / ₈ x 30 ¹ / ₈ x 33 ³ / ₈	1229 x 766 x 848
TWT-48D-4-HC	0/4	N/A	1/5	3.0	330 (150)	48 ³ / ₈ x 30 ¹ / ₈ x 33 ³ / ₈	1229 x 766 x 848
TWT-60D-2-HC	1/2	2	1/4	4.0	345 (157)	60 ³ / ₈ x 30 ¹ / ₈ x 33 ³ / ₈	1534 x 766 x 848
TWT-60D-4-HC	0/4	N/A	1/4	4.0	410 (186)	60 ³ / ₈ x 30 ¹ / ₈ x 33 ³ / ₈	1534 x 766 x 848

† Depth does not include 1" (26mm) for rear bumpers.

* Height does not include 6¹/₄" (159mm) for castors or 6" (153mm) for optional legs.

note: Door/drawer combination cabinets require customer to designate door/drawer orientation.

Environmentally friendly R290 hydrocarbon refrigeration system for the best in food preservation.



WORKTOP DEEP REFRIGERATORS

Solid Doors & Drawers



TWT-67D-2-HC



TWT-44F-HC



TWT-60-32D-2-HC



TWT-67D-4-HC



TWT-93D-4-HC

Features/Benefits

- Refrigerators maintain cold 33°F to 38°F (0.5°C to 3.3°C) product temperatures.
 - All stainless steel front, top and sides.
 - Corrosion resistant GalFan coated steel back.
 - Interior - attractive, clear aluminum sides and top, coved corners and stainless steel floor.
 - One piece formed construction backsplash prevents bacteria and food particles from being trapped underneath as with other two piece worktop units.
 - 360° circular airflow for uniform product cooling.
 - Recessed handles.
 - Adjustable, heavy-duty, PVC-coated wire shelves (not available in drawered models).
 - Work surface 36" (915mm) high.
 - Swing doors are self-closing with 90° stay open feature.
 - Accommodates half bun tray rack; applies to only one door of TWT-60-32-HC (18" x 26" sheet pan (458mm x 661mm)) - not included.
 - ADA compliant with 34" (864mm) work surface height available; no charge. (models -27, -36, -48, -60, -72).
 - All production of True models comply with NSF/ANSI standard 7.
 - Self-contained system.
- Drawer Models have...**
- Accommodates one 12"L x 20"W x 8"D (305mm x 508mm x 204mm) full size pan or two 1/2 pans or three 1/3 pans per drawer. (48" (1,220mm) models accommodate one 12"L x 18"W x 6"D (305mm x 408mm x 153mm) food storage box or one 1/3 size and one 1/2 size pan per drawer; not included).
 - Door/drawer combination models require customer to designate door/drawer orientation.



TWT™ DEEP WORKTOP REFRIGERATORS

Model	Door/Drawers	# of Shelves	HP	Amps	Crated Weight lb. (kg.)	Cabinet Dimensions W D† H* (in)	Cabinet Dimensions W D† H* (mm)
SOLID DOORS							
TWT-44-HC	1/0	2	1/10	1.7	320 (130)	44½ x 32¾ x 33¾	1131 x 823 x 848
TWT-60-32-HC	2/0	4	1/10	1.7	415 (189)	60¼ x 32¾ x 33¾	1531 x 823 x 848
TWT-67-HC	2/0	4	1/10	1.7	410 (186)	67¼ x 32¾ x 33¾	1709 x 823 x 848
TWT-93-HC	3/0	6	1/5	2.2	550 (250)	93¼ x 32¾ x 33¾	2369 x 823 x 848
WITH DRAWERS OR DOOR/DRAWER COMBO							
TWT-44D-2-HC	0/2	N/A	1/10	1.7	320 (146)	44½ x 32¾ x 33¾	1131 x 823 x 848
TWT-60-32D-2-HC	1/2	2	1/10	1.7	415 (189)	60¼ x 32¾ x 33¾	1531 x 823 x 848
TWT-67D-2-HC	1/2	2	1/10	1.7	430 (196)	67¼ x 32¾ x 33¾	1709 x 823 x 848
TWT-67D-4-HC	0/4	N/A	1/10	1.7	500 (186)	67¼ x 32¾ x 33¾	1709 x 823 x 848
TWT-93D-2-HC	2/2	4	1/5	2.2	580 (264)	93¼ x 32¾ x 33¾	2369 x 823 x 848
TWT-93D-4-HC	1/4	2	1/5	2.2	580 (264)	93¼ x 32¾ x 33¾	2369 x 823 x 848
TWT-93D-6-HC	0/6	N/A	1/5	2.2	550 (250)	93¼ x 32¾ x 33¾	2369 x 823 x 848

† Depth does not include 1" (26mm) for rear bumpers or ¼" (7mm) for front bumper.

* Height does not include 6¼" (159mm) for castors or 6" (153mm) for optional legs.

note: Door/drawer combination cabinets require customer to designate door/drawer orientation.

Environmentally friendly R290 hydrocarbon refrigeration system for the best in food preservation.



WORKTOP REFRIGERATORS ~SPEC3 SERIES

Solid Doors & Drawers



TWT-48D-2-HC~SPEC3



TWT-27F-HC~SPEC3



TWT-27D-2-HC~SPEC3



TWT-60D-2-HC~SPEC3



TWT-72-HC~SPEC3

Features/Benefits

- Refrigerators maintain cold 33°F to 38°F (0.5°C to 3.3°C) product temperatures.
 - All stainless steel front, countertop, sides, and back.
 - Interior - attractive, clear aluminum sides and top, coved corners and stainless steel floor.
 - One piece formed construction backsplash prevents bacteria and food particles from being trapped underneath as with other two piece worktop units
 - Adjustable, heavy-duty, PVC-coated wire shelves (not available in drawered models).
 - Heavy-duty 16 gauge top and 20 gauge door and drawer fronts.
 - Work surface 36" (915mm) high.
 - Swing doors are self-closing with 90° stay open feature.
 - ADA compliant with 34" (864mm) work surface height available; no charge. (models -27, -36, -48, -60, -72).
 - All production of True models comply with NSF/ANSI standard 7.
 - Self-contained system.
- Drawer Models have...**
- Accommodates one 12" L x 20" W x 6" D (305mm x 508mm x 153mm) full size pan or two 1/2 pans or three 1/3 pans per drawer. (48" (1,220mm) models accommodate one 12" L x 18" W x 6" D (305mm x 408mm x 153mm) food storage box or one 1/3 size and one 1/2 size pan per drawer; not included).
 - Door/drawer combination models require customer to designate door/drawer orientation.



TWT™ WORKTOP REFRIGERATORS ~SPEC3 SERIES

Model	Door/Drawers	# of Shelves	HP	Amps	Crated Weight lb. (kg.)	Cabinet Dimensions W D† H* (in)	Cabinet Dimensions W D† H* (mm)
SOLID DOORS							
TWT-27-HC~SPEC3	1/0	2	1/6	2.0	195 (89)	27 ⁵ / ₈ x 29 ¹ / ₈ x 33 ¹ / ₄	702 x 740 x 845
TWT-36-HC~SPEC3	2/0	4	1/6	2.0	240 (109)	36 ³ / ₈ x 29 ¹ / ₈ x 33 ¹ / ₄	924 x 740 x 845
TWT-48-HC~SPEC3	2/0	4	1/6	2.0	280 (128)	48 ³ / ₈ x 29 ¹ / ₈ x 33 ¹ / ₄	1229 x 740 x 845
TWT-60-HC~SPEC3	2/0	4	1/4	4.0	345 (157)	60 ³ / ₈ x 29 ¹ / ₈ x 33 ¹ / ₄	1534 x 740 x 845
TWT-72-HC~SPEC3	3/0	6	1/4	4.0	405 (184)	72 ³ / ₈ x 29 ¹ / ₈ x 33 ¹ / ₄	1839 x 740 x 845
WITH DRAWERS OR DOOR/DRAWER COMBO							
TWT-27D-2-HC~SPEC3	0/2	N/A	1/6	2.0	195 (89)	27 ⁵ / ₈ x 29 ¹ / ₈ x 33 ¹ / ₄	702 x 740 x 845
TWT-48D-2-HC~SPEC3	1/2	2	1/6	3.0	330 (150)	48 ³ / ₈ x 29 ¹ / ₈ x 33 ¹ / ₄	1229 x 740 x 845
TWT-48D-4-HC~SPEC3	0/4	N/A	1/6	3.0	330 (150)	48 ³ / ₈ x 29 ¹ / ₈ x 33 ¹ / ₄	1229 x 740 x 845
TWT-60D-2-HC~SPEC3	1/2	2	1/4	4.0	345 (157)	60 ³ / ₈ x 29 ¹ / ₈ x 33 ¹ / ₄	1534 x 740 x 845
TWT-60D-4-HC~SPEC3	0/4	N/A	1/4	4.0	410 (186)	60 ³ / ₈ x 29 ¹ / ₈ x 33 ¹ / ₄	1534 x 740 x 845

† Depth does not include 1 1/2" (39 mm) for door handles.

† Depth does not include 1" (26mm) for rear bumpers.

* Height does not include 6 1/4" (159mm) for castors or 6" (153mm) for optional legs.

note: Door/drawer combination cabinets require customer to designate door/drawer orientation.

Environmentally friendly R290 hydrocarbon refrigeration system for the best in food preservation.



WORKTOP DEEP REFRIGERATORS ~SPEC3 SERIES

Solid Doors & Drawers



TWT-67D-2-HC~SPEC3



TWT-44D-2-HC-SPEC3



TWT-44-HC-SPEC3



TWT-60-32F-HC-SPEC3



TWT-93D-6-HC-SPEC3

Features/Benefits

- Refrigerators maintain cold 33°F to 38°F (0.5°C to 3.3°C) product temperatures.
 - All stainless steel front, countertop, sides and back.
 - Interior - attractive, clear aluminum sides and top, coved corners and stainless steel floor.
 - One piece formed construction backsplash prevents bacteria and food particles from being trapped underneath as with other two piece worktop units.
 - 360° circular airflow for uniform product cooling.
 - Adjustable, heavy-duty, PVC-coated wire shelves (not available in drawer models).
 - Heavy-duty 16 gauge top and 20 gauge door and drawer fronts.
 - Work surface 36" (915mm) high.
 - Swing doors are self-closing with 90° stay open feature.
 - Accommodates half bun tray rack; applies to only one door of TWT-60-32-HC (18" x 26" sheet pan (458mm x 661mm)) - not included.
 - ADA compliant with 34" (864mm) work surface height available; no charge. (models -27, -36, -48, -60, -72).
 - All production of True models comply with NSF/ANSI standard 7.
 - Self-contained system.
- Drawer Models have...**
- Accommodates one 12"L x 20"W x 8"D (305mm x 508mm x 204mm) full size pan or two 1/2 pans or three 1/3 pans per drawer. (48" (1,220mm) models accommodate one 12"L x 18"W x 6"D (305mm x 408mm x 153mm) food storage box or one 1/3 size and one 1/2 size pan per drawer; not included).
 - Door/drawer combination models require customer to designate door/drawer orientation.



TWT™ DEEP WORKTOP REFRIGERATORS ~SPEC3 SERIES

Model	Door/Drawers	# of Shelves	HP	Amps	Crated Weight lb. (kg.)	Cabinet Dimensions W D† H* (in)	Cabinet Dimensions W D† H* (mm)
SOLID DOORS							
TWT-44-HC~SPEC3	1/0	2	1/10	1.7	320 (146)	44 7/8 x 32 1/4 x 33 1/4	1138 x 820 x 845
TWT-60-32-HC~SPEC3	2/0	4	1/10	1.7	415 (189)	60 1/4 x 32 1/4 x 33 1/4	1531 x 820 x 845
TWT-67-HC~SPEC3	2/0	4	1/10	1.7	410 (186)	67 1/4 x 32 1/4 x 33 1/4	1709 x 820 x 845
TWT-93-HC~SPEC3	3/0	6	1/5	2.2	550 (250)	93 1/4 x 32 1/4 x 33 1/4	2369 x 820 x 845
WITH DRAWERS OR DOOR/DRAWER COMBO							
TWT-44D-2-HC~SPEC3	0/2	N/A	1/10	1.7	320 (146)	44 7/8 x 32 1/4 x 33 1/4	1138 x 820 x 845
TWT-60-32D-2-HC~SPEC3	1/2	2	1/10	1.7	415 (189)	60 1/4 x 32 1/4 x 33 1/4	1531 x 820 x 845
TWT-67D-2-HC~SPEC3	1/2	2	1/10	1.7	430 (196)	67 1/4 x 32 1/4 x 33 1/4	1709 x 820 x 845
TWT-67D-4-HC~SPEC3	0/4	N/A	1/10	1.7	500 (227)	67 1/4 x 32 1/4 x 33 1/4	1709 x 820 x 845
TWT-93D-2-HC~SPEC3	2/2	4	1/5	2.2	580 (264)	93 1/4 x 32 1/4 x 33 1/4	2369 x 820 x 845
TWT-93D-4-HC~SPEC3	1/4	2	1/5	2.2	580 (264)	93 1/4 x 32 1/4 x 33 1/4	2369 x 820 x 845
TWT-93D-6-HC~SPEC3	0/6	N/A	1/5	2.2	550 (250)	93 1/4 x 32 1/4 x 33 1/4	2369 x 820 x 845

† Depth does not include 1 1/2" (39 mm) for door handles.

‡ Depth does not include 1" (26mm) for rear bumpers or 1/4" (7mm) for front bumper.

* Height does not include 6 1/4" (159mm) for castors or 6" (153mm) for optional legs.

note: Door/drawer combination cabinets require customer to designate door/drawer orientation.

Environmentally friendly R290 hydrocarbon refrigeration system for the best in food preservation.



WORKTOP FREEZERS

Solid Doors



TWT-48F-HC



TWT-27F-HC



TWT-60F-HC

Features/Benefits

- Freezers maintain -10°F (-23.3°C) product temperatures.
- Automatic defrost system on freezer models time-initiated, time-terminated.
- All stainless steel front, top and sides.
- Corrosion resistant GalFan coated steel back.
- Interior - attractive, clear aluminum sides and top, coved corners and stainless steel floor.
- One piece formed construction backslash prevents bacteria and food particles from being trapped underneath as with other two piece worktop units
- Recessed handles
- Adjustable, heavy-duty, PVC-coated wire shelves (not available in drawered models).
- Work surface 36" (915mm) high.

- Swing doors are self-closing with 90° stay open feature.
- ADA compliant with 34" (864mm) work surface height available; no charge. (models -27, -36, -48, -60, -72).
- All production of True models comply with NSF/ANSI standard 7.
- Self-contained system.

Drawer Models have...

- Accommodates one 12"L x 20"W x 6"D (305mm x 508mm x 153mm) full size pan or two 1/2 pans or three 1/3 pans per drawer. (48" (1,220mm) models accommodate one 12"L x 18"W x 6"D (305mm x 408mm x 153mm) food storage box or one 1/3 size and one 1/2 size pan per drawer; not included).
- Door/drawer combination models require customer to designate door/drawer orientation.



TWT™ WORKTOP FREEZERS

Model	Door/Drawers	# of Shelves	HP	Amps	Crated Weight lb. (kg.)	Cabinet Dimensions W D† H* (in)	Cabinet Dimensions W D† H* (mm)
SOLID DOORS							
TWT-27F-HC	1/0	2	¼	2.3	210 (96)	27½ x 30½ x 33¾	702 x 766 x 848
TWT-48F-HC	2/0	4	⅓	3.2	285 (130)	48¾ x 30½ x 33¾	1229 x 766 x 848
TWT-60F-HC	2/0	4	½	4.8	375 (171)	60¾ x 30½ x 33¾	1534 x 766 x 848

† Depth does not include 1" (26mm) for rear bumpers.

* Height does not include 6¼" (159mm) for castors or 6" (153mm) for optional legs.

Environmentally friendly R290 hydrocarbon refrigeration system for the best in food preservation.



WORKTOP DEEP FREEZERS

Solid Doors



TWT-67F-HC



TWT-44F-HC



TWT-60-32F-HC

Features/Benefits

- Freezers maintain -10°F (-23.3°C) product temperatures.
 - Automatic defrost system on freezer models time-initiated, time-terminated.
 - All stainless steel front, top and sides.
 - Corrosion resistant GalFan coated steel back.
 - Interior - attractive, clear aluminum sides and top, coved corners and stainless steel floor.
 - One piece formed construction backsplash prevents bacteria and food particles from being trapped underneath as with other two piece worktop units.
 - 360° circular airflow for uniform product cooling.
 - Recessed handles.
 - Adjustable, heavy-duty, PVC-coated wire shelves (not available in drawered models).
 - Work surface 36" (915mm) high.
 - Swing doors are self-closing with 90° stay open feature.
 - Accommodates half bun tray rack; applies to only one door of TWT-60-32-HC (18" x 26" sheet pan (458mm x 661mm)) - not included.
 - ADA compliant with 34" (864mm) work surface height available; no charge. (models -27, -36, -48, -60, -72).
 - All production of True models comply with NSF/ANSI standard 7.
 - Self-contained system.
- Drawer Models have...**
- Accommodates one 12" L x 20" W x 8" D (305mm x 508mm x 204mm) full size pan or two 1/2 pans or three 1/3 pans per drawer. (48" (1,220mm) models accommodate one 12" L x 18" W x 6" D (305mm x 408mm x 153mm) food storage box or one 1/3 size and one 1/2 size pan per drawer; not included).
 - Door/drawer combination models require customer to designate door/drawer orientation.



TWT™ DEEP WORKTOP FREEZERS

Model	Door/Drawers	# of Shelves	HP	Amps	Crated Weight lb. (kg.)	Cabinet Dimensions W D† H* (in)	Cabinet Dimensions W D† H* (mm)
SOLID DOORS							
TWT-44F-HC	1/0	2	½	5.8	320 (146)	44½ x 32¾ x 33¾	1131 x 823 x 848
TWT-60-32F-HC	2/0	4	½	5.8	415 (189)	60¼ x 32¾ x 33¾	1531 x 823 x 848
TWT-67F-HC	2/0	4	½	5.8	440 (200)	67¼ x 32¾ x 33¾	1709 x 823 x 848

† Depth does not include 1" (26mm) for rear bumpers or ¼" (7mm) for front bumper.
 * Height does not include 6¼" (159mm) for castors or 6" (153mm) for optional legs.

Environmentally friendly R290 hydrocarbon refrigeration system for the best in food preservation.



WORKTOP FREEZERS ~SPEC3 SERIES

Solid Doors

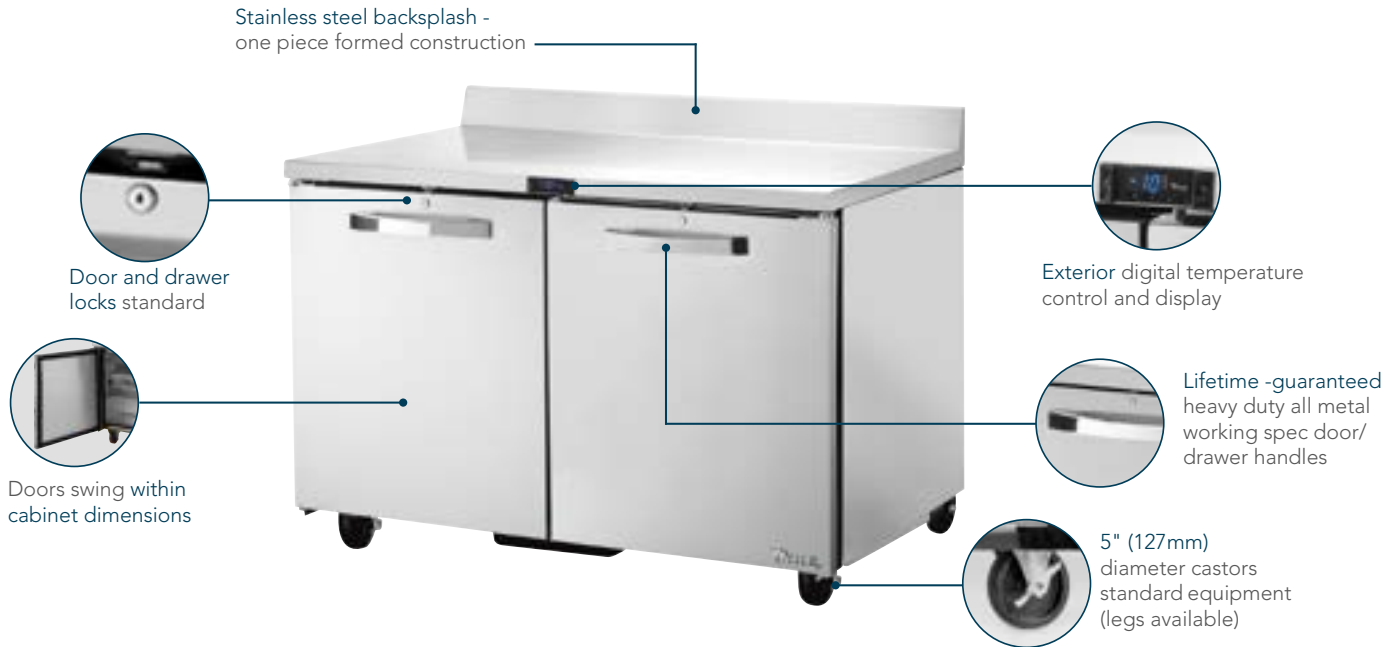

TWT-48F-HC~SPEC3



TWT-27F-HC~SPEC3



TWT-60D-2-HC~SPEC3

Features/Benefits

- Freezers maintain -10°F (-23.3°C) product temperatures.
- Automatic defrost system on freezer models time-initiated, time-terminated.
- All stainless steel front, countertop, sides, and back.
- Interior - attractive, clear aluminum sides and top, coved corners and stainless steel floor.
- One piece formed construction backsplash prevents bacteria and food particles from being trapped underneath as with other two piece worktop units
- Adjustable, heavy-duty, PVC-coated wire shelves (not available in drawer models).
- Heavy-duty 16 gauge top and 20 gauge door and drawer fronts.
- Work surface 36" (915mm) high.

- Swing doors are self-closing with 90° stay open feature.
- ADA compliant with 34" (864mm) work surface height available; no charge. (models -27, -36, -48, -60, -72).
- All production of True models comply with NSF/ANSI standard 7.
- Self-contained system.

Drawer Models have...

- Accommodates one 12" L x 20" W x 6" D (305mm x 508mm x 153mm) full size pan or two 1/2 pans or three 1/3 pans per drawer. (48" (1,220mm) models accommodate one 12" L x 18" W x 6" D (305mm x 408mm x 153mm) food storage box or one 1/3 size and one 1/2 size pan per drawer; not included).
- Door/drawer combination models require customer to designate door/drawer orientation.



TWT™ WORKTOP FREEZERS ~SPEC3 SERIES

Model	Door/Drawers	# of Shelves	HP	Amps	Crated Weight lb. (kg.)	Cabinet Dimensions W D† H* (in)	Cabinet Dimensions W D† H* (mm)
SOLID DOORS							
TWT-27F-HC~SPEC3	1/0	2	¼	2.3	210 (96)	27½ x 29½ x 33¼	702 x 740 x 845
TWT-48F-HC~SPEC3	2/0	4	⅓	3.2	285 (130)	48¾ x 29½ x 33¼	1229 x 740 x 845
TWT-60F-HC~SPEC3	2/0	4	½	4.8	375 (171)	60¾ x 29½ x 33¼	1534 x 740 x 845

† Depth does not include 1½" (39 mm) for door handles.

† Depth does not include 1" (26mm) for rear bumpers.

* Height does not include 6¼" (159mm) for castors or 6" (153mm) for optional legs.

Environmentally friendly R290 hydrocarbon refrigeration system for the best in food preservation.



WORKTOP DEEP FREEZERS ~SPEC3 SERIES

Solid Doors



TWT-44F-HC~SPEC3



TWT-60-32F-HC~SPEC3

Features/Benefits

- Freezers maintain -10°F (-23.3°C) product temperatures.
 - Automatic defrost system on freezer models time-initiated, time-terminated.
 - All stainless steel front, countertop, sides and back.
 - Interior - attractive, clear aluminum sides and top, coved corners and stainless steel floor.
 - One piece formed construction backsplash prevents bacteria and food particles from being trapped underneath as with other two piece worktop units.
 - 360° circular airflow for uniform product cooling.
 - Adjustable, heavy-duty, PVC-coated wire shelves (not available in drawered models).
 - Heavy-duty 16 gauge top and 20 gauge door and drawer fronts.
 - Work surface 36" (915mm) high.
 - Swing doors are self-closing with 90° stay open feature.
 - Accommodates half bun tray rack; applies to only one door of TWT-60-32-HC (18" x 26" sheet pan (458mm x 661mm)) - not included.
 - ADA compliant with 34" (864mm) work surface height available; no charge. (models -27, -36, -48, -60, -72).
 - All production of True models comply with NSF/ANSI standard 7.
 - Self-contained system.
- Drawer Models have...**
- Accommodates one 12" L x 20" W x 8" D (305mm x 508mm x 204mm) full size pan or two 1/2 pans or three 1/3 pans per drawer. (48" (1,220mm) models accommodate one 12" L x 18" W x 6" D (305mm x 408mm x 153mm) food storage box or one 1/3 size and one 1/2 size pan per drawer; not included).
 - Door/drawer combination models require customer to designate door/drawer orientation.



TWT™ DEEP WORKTOP FREEZERS ~SPEC3 SERIES

Model	Door/Drawers	# of Shelves	HP	Amps	Crated Weight lb. (kg.)	Cabinet Dimensions W D† H* (in)	Cabinet Dimensions W D† H* (mm)
SOLID DOORS							
TWT-44F-HC~SPEC3	1/0	2	½	5.8	320 (146)	44¾ x 32¼ x 33¼	1138 x 820 x 845
TWT-60-32F-HC~SPEC3	2/0	4	½	5.8	415 (189)	60¼ x 32¼ x 33¼	1531 x 820 x 845
TWT-67F-HC~SPEC3	2/0	4	½	5.8	440 (200)	67¼ x 32¼ x 33¼	1709 x 820 x 845

† Depth does not include 1½" (39 mm) for door handles.

† Depth does not include 1" (26mm) for rear bumpers.

* Height does not include 6¼" (159mm) for castors or 6" (153mm) for optional legs.

Environmentally friendly R290 hydrocarbon refrigeration system for the best in food preservation.



AMERICAN DISABILITY ACT (ADA) COMPLIANT PACKAGES

Solid Doors & Drawers



ADA models feature 3" (77mm) diameter castors

TWT-48-HC

Features/Benefits

- True worktop units are designed to accommodate American Disabilities Act (ADA) requirements.
- ADA Compliant models have 3" (127mm) castors
- ADA Compliant models have 34" (864mm) counter heights.

True Worktop Units Are Designed To Accommodate American Disabilities Act (ADA) Requirements.

PLAN VIEW COMPARISON

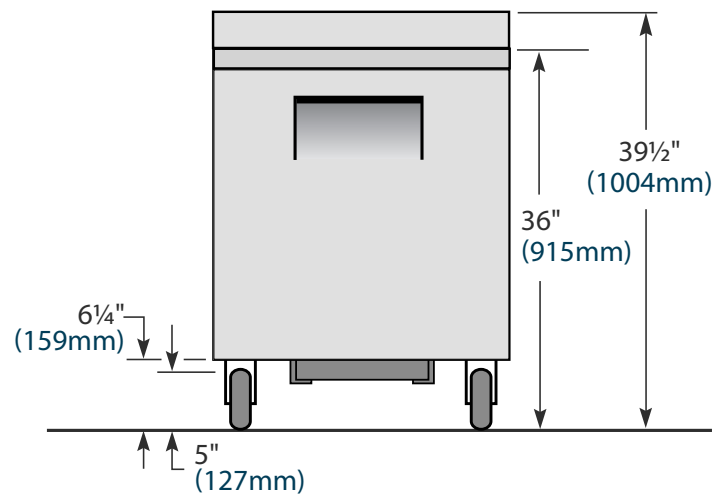

Standard

36" (915mm) Height

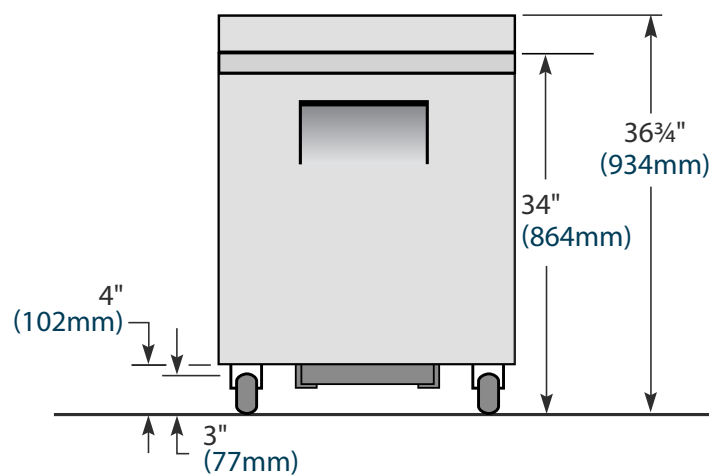

ADA Compliant

34" (864mm) Height



CHEF BASE REFRIGERATION



High-performance chef base cabinets are developed to increase productivity and kitchen workflow. Each provides an ideal work surface for charbroiling, grilling, and frying while providing convenient refrigerated space underneath, accessible with gliding drawers that accommodate multiple-size food pans. Durability is delivered with one-piece cabinet construction, stainless steel exterior, and an aluminum back.



CHEF BASE & CHEF BASE ~SPEC3 SERIES REFRIGERATORS *Solid Drawers*

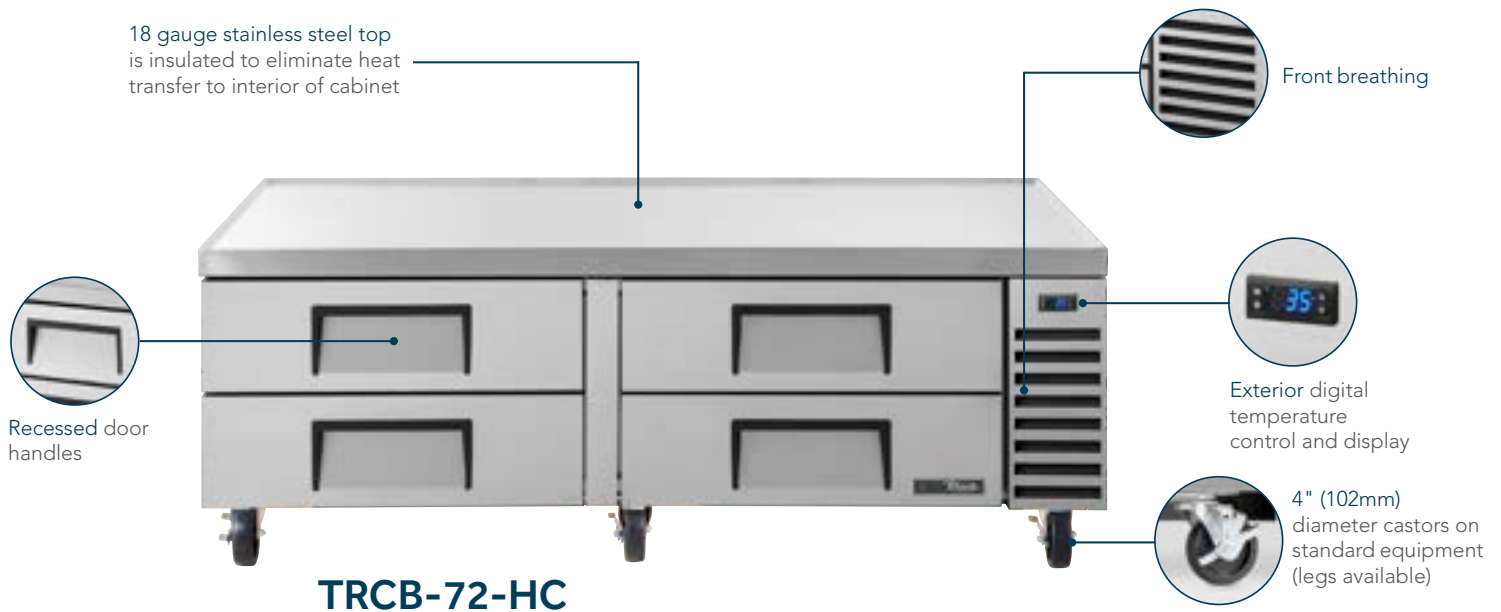

TRCB-52-60-HC



TRCB-79-HC



TRCB-82-86-HC-SPEC3

Features/Benefits

- Refrigerators maintain cold 33°F to 38°F (0.5°C to 3.3°C) product temperatures.
- Automatic defrost system on freezer models time-initiated, time-terminated.
- All stainless steel front, top and sides.
- Interior - attractive, clear aluminum liner. Stainless steel floor with covered corners.
- Chef base top is made of one-piece heavy-duty, 18 gauge, reinforced stainless steel with drip guard (16 gauge tops available for additional charge). True's drip resistant "V" edge protects against spills.
- Strong, durable construction - One section cabinet countertop supports up to 717 pounds (326kg) of equipment. Two section cabinet countertop supports up to 1,084 pounds (492kg) of equipment. Three section cabinet countertop supports up to 2,000 pounds (907kg) of equipment.
- Drawer facings, liners and frames are stainless steel.
- Each drawer is equipped with full perimeter magnetic gaskets (removable for cleaning).
- Accommodates two 12" (305mm)L x 20" (508mm)W x 4" (102mm)D pans per drawer (TRCB-52's, TRCB-96 and left side drawers of TRCB-82's accommodate three 12" (305mm)L x 20" (508mm)W x 4" (102mm)D pans per drawer). TRCB-36 accommodates one 12" (305mm)L x 20" (508mm)W x 4" (102mm)D pan and three 6" (153mm)L x 6" (153mm)W x 4" (102mm)D pans per drawer. Pans not included.
- One, heavy gauge, removable, stainless steel pan divider per drawer (two pan dividers per drawer standard on TRCB-52's, TRCB-96 and left side drawers of TRCB-82's).
- TRCB-52-60, TRCB-79-86, TRCB-82-84 & TRCB-82-86 feature extended heavy-duty top for additional equipment space.
- All TRCB units are available with a flat top option (no marine edge) at no extra charge when unit is ordered with option (lead time may apply).
- Drawer locks available for all units for additional charge.



TRCB™ CHEF BASE REFRIGERATORS

Model	Drawers	HP	Amps	Crated Weight lb. (kg.)	Cabinet Dimensions W D† H* (in)	Cabinet Dimensions W D† H* (mm)
WITH DRAWERS						
TRCB-36-HC	2	¼	2.4	250 (113)	36¾ x 32½ x 20½	924 x 816 x 520
TRCB-48-HC	2	¼	2.4	325 (148)	48¾ x 32½ x 20½	1229 x 816 x 520
TRCB-52-HC	2	¼	2.4	350 (159)	51¾ x 32½ x 20½	1318 x 816 x 520
TRCB-52-60-HC	2	¼	2.4	370 (168)	60 x 32½ x 20½	1524 x 816 x 520
TRCB-72-HC	4	½	4.4	435 (198)	72¾ x 32½ x 20½	1839 x 816 x 520
TRCB-79-HC	4	½	4.4	495 (225)	79¼ x 30½ x 20½	2013 x 775 x 520
TRCB-79-86-HC	4	½	4.4	490 (223)	86¼ x 30½ x 20½	2191 x 775 x 520
TRCB-82-HC	4	½	4.4	475 (215)	82¾ x 32½ x 20½	2093 x 816 x 520
TRCB-82-84-HC	4	½	4.4	555 (252)	84 x 32½ x 20½	2134 x 816 x 520
TRCB-82-86-HC	4	½	4.4	495 (225)	86¼ x 32½ x 20½	2191 x 816 x 520
TRCB-96-HC	4	½	4.4	610 (277)	95½ x 32½ x 20½	2426 x 816 x 520
TRCB-110-HC	6	½	4.4	695 (316)	110 x 30½ x 20½	2794 x 775 x 520

† Depth does not include 1" (26mm) for rear bumpers

* Height does not include 5" (127mm) for castors or 6" (153mm) for optional legs.

TRCB™ CHEF BASE REFRIGERATORS ~SPEC3 SERIES

Model	Drawers	HP	Amps	Crated Weight lb. (kg.)	Cabinet Dimensions W D† H* (in)	Cabinet Dimensions W D† H* (mm)
WITH DRAWERS						
TRCB-36-HC~SPEC3	2	¼	2.4	250 (113)	36¾ x 32½ x 20½	924 x 816 x 520
TRCB-48-HC~SPEC3	2	¼	2.4	325 (148)	48¾ x 32½ x 20½	1229 x 816 x 520
TRCB-52-HC~SPEC3	2	¼	2.4	350 (159)	51¾ x 32½ x 20½	1318 x 816 x 520
TRCB-52-60-HC~SPEC3	2	¼	2.4	370 (168)	60 x 32½ x 20½	1524 x 816 x 520
TRCB-72-HC~SPEC3	4	½	4.4	435 (198)	72¾ x 32½ x 20½	1839 x 816 x 520
TRCB-79-HC~SPEC3	4	½	4.4	495 (225)	79¼ x 30½ x 20½	2013 x 775 x 520
TRCB-79-86-HC~SPEC3	4	½	4.4	490 (223)	86¼ x 30½ x 20½	2191 x 775 x 520
TRCB-82-HC~SPEC3	4	½	4.4	475 (215)	82¾ x 32½ x 20½	2093 x 816 x 520
TRCB-82-84-HC~SPEC3	4	½	4.4	555 (252)	84 x 32½ x 20½	2134 x 816 x 520
TRCB-82-86-HC~SPEC3	4	½	4.4	495 (225)	86¼ x 32½ x 20½	2191 x 816 x 520
TRCB-96-HC~SPEC3	4	½	4.4	610 (277)	95½ x 32½ x 20½	2426 x 816 x 520
TRCB-110-HC~SPEC3	6	½	4.4	695 (316)	110 x 30½ x 20½	2794 x 775 x 520

† Depth does not include 1½" (39 mm) for door handles.

† Depth does not include 1" (26mm) for rear bumpers

* Height does not include 5" (127mm) for castors or 6" (153mm) for optional legs.

~SPEC3 Models have...

- All stainless steel front, countertop, sides, and back.
- Interior features stainless steel liner and stainless steel floor with coved corners.
- Heavy-duty top and 20 gauge drawer fronts.
- Lifetime-guaranteed heavy duty all metal working spec drawer handles.
- Drawer locks standard.

Recommended Operating Conditions

- Installation of a heat shield is recommended for optimum performance (supplied by others)
- Counter top cooking equipment should be used in conjunction with the manufacturers supplied legs.
- Minimum clearance of 4" required between bottom of cooking equipment heating element and TRCB top. Failure to provide clearance voids manufacturer warranty.

Environmentally friendly R290 hydrocarbon refrigeration system for the best in food preservation.





MERCHANDISERS



True's merchandiser refrigerators drive high impulse sales with oversized designs and beautiful lighting, creating product excitement and maximizing the selection you can offer at your store. Since 1958, we've been the world's #1 manufacturer in this category.





GLASS DOOR MERCHANTISERS

True's glass door merchandisers are the industry standard in glass door cold storage. With more than 70 models to choose from in a wide variety of sizes, styles, and holding temps, the GDM® is the perfect choice to showcase your refrigerated products for maximum impulse sales.



CONTEMPORARY VISUAL MERCHANDISER REFRIGERATORS Swing Doors

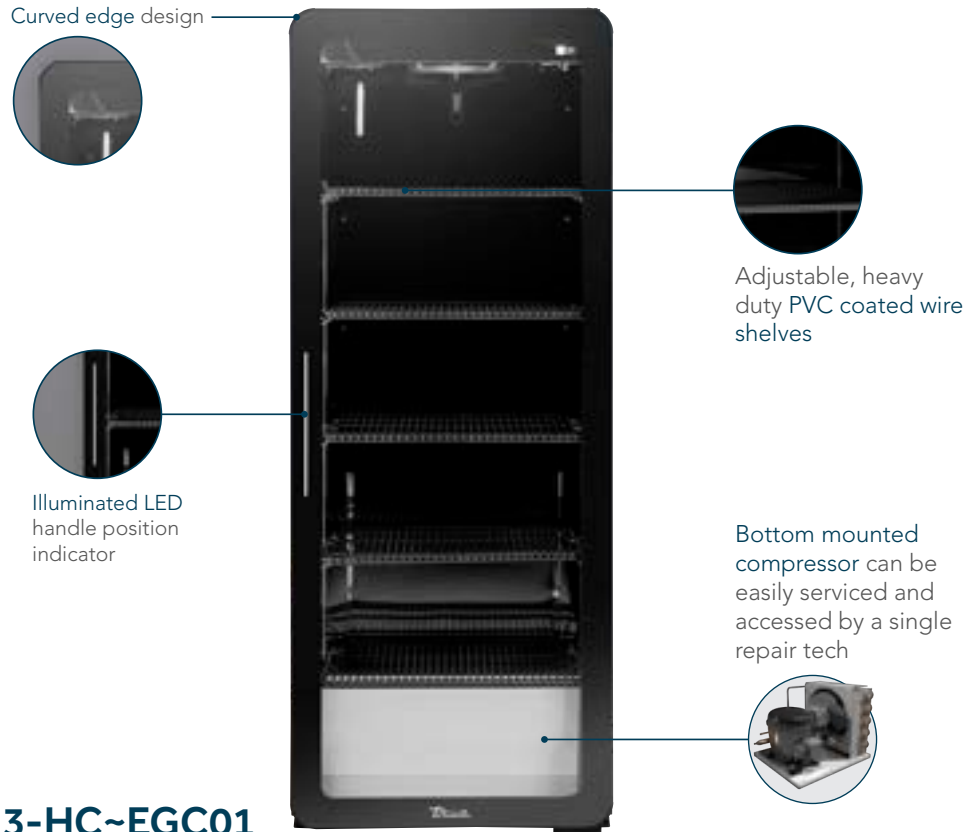

CVM-13-HC~EGC01



CVM-11-HC-EGC01



CVM-20-HC-EGC01



CVM-24-HC-EGC01



CVM-27-HC-EGC01

Features/Benefits

- Refrigerators maintain cold 33°F to 38°F (0.5°C to 3.3°C) temperature.
- True's Contemporary Series is built with durability, stability, and style in mind. Through the series' curved edge design it redefines merchandising with its inspired product displays and increased beverage storage.
- Exterior - non-peel or chip black powder coated cold rolled steel; durable and permanent.
- Interior - attractive, black aluminum interior liner with stainless steel floor.
- LED interior lighting provides more even lighting throughout the cabinet. Safety shielded.
- Self closing door. Positive seal, torsion type closure system.
- Self-contained system.
- The curved-edged door design has a built-in handle for opening the door from the top or side.
- Exterior Digital Temperature Display (CVM-27-HC~EGC01).
- "Low-E", double pane thermal insulated glass door assembly with mitered plastic channel frame. The latest in energy efficient technology.
- Door sign decal. Variety of decal options available.
- See our website www.truemfg.com for the latest color & sign offerings.
- Optional white or stainless interiors available. Upcharge and lead times will apply.
- Optional stainless exteriors available. Upcharge and lead times will apply.



CVM™ CONTEMPORARY VISUAL MERCHANDISER REFRIGERATORS

Model	# of Doors	# of Shelves	HP	Amps	Crated Weight lb. (kg.)	Cabinet Dimensions W D† H* (in)	Cabinet Dimensions W D† H* (mm)
SWING DOORS REFRIGERATORS							
CVM-11-HC-EGC01	1	4	1/5	2.5	210 (95)	24 ⁷ / ₈ x 22 ⁷ / ₈ x 53 ³ / ₈	630 x 581 x 1360
CVM-13-HC-EGC01	1	5	1/5	2.5	235 (107)	24 ⁷ / ₈ x 22 ⁷ / ₈ x 63 ³ / ₄	630 x 581 x 1619
CVM-20-HC-EGC01	1	6	1/4	3.4	320 (146)	27 x 24 ¹ / ₂ x 78 ¹ / ₂	686 x 623 x 1994
CVM-24-HC-EGC01	1	6	1/4	3.4	330 (150)	27 x 29 ¹ / ₂ x 78 ¹ / ₂	686 x 750 x 1994
CVM-27-HC-EGC01	1	6	1/4	3.4	340 (154)	30 x 29 ¹ / ₂ x 78 ¹ / ₂	762 x 747 x 1994

† Depth does not include 5/8" (16mm) for rear mechanical components.

Environmentally friendly R290 hydrocarbon refrigeration system for the best in food preservation.



GLASS DOOR MERCHANDISER REFRIGERATORS

Swing Door

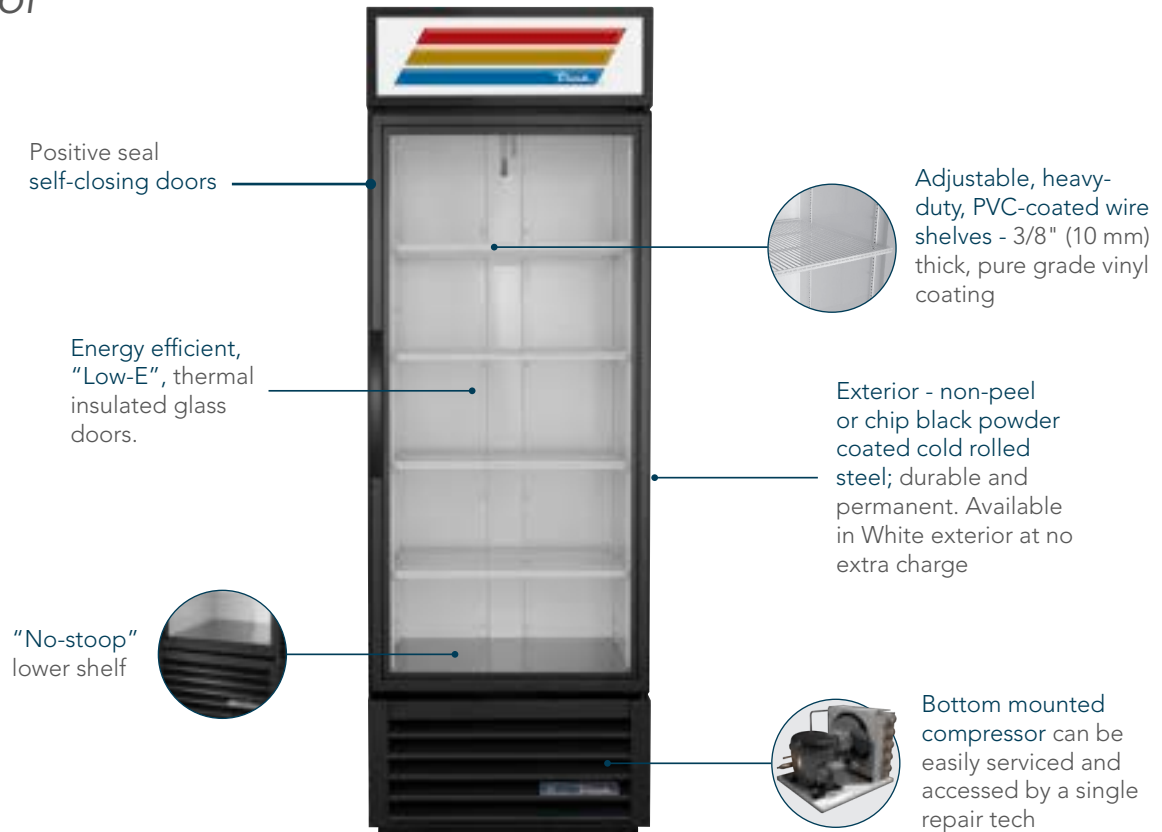

GDM-23-HC~TSL01



GDM-10PT-HC~TSL01



GDM-35SL-RF-HC-LD



GDM-49RL-HC~TSL01



GDM-72-HC~TSL01

Features/Benefits

- Maintains cold 33°F to 38°F (0.5°C to 3.3°C) product temperatures.
- Interior - attractive, white aluminum with stainless steel floor.
- LED interior lighting provides more even lighting throughout the cabinet. Safety shielded.
- Illuminated sign panel included (decals on GDM-10-HC~TSL01, GDM-10-58-HC~TSL01, GDM-10-58L-HC~TSL01, GDM-10-58R-HC~TSL01, GDM-10-58T-HC~TSL01 & GDM-12-HC~TSL01).
- See our website www.truemfg.com for the latest color & sign offerings.
- Available with optional legs or 2½" (64mm) diameter castors. GDM-10-

HC-LD, GDM-10SSL-LD, & GDM-12-HC-LD available with optional 2½" (64mm) diameter castors only.

- Optional red wine, white wine, or chocolate thermostat available.
- Allows for top storage.

Rear-Load Models...

- GDM-49RL-HC~TSL01 rear doors are black powder coated solid swing doors with recessed handles.

Radius Front Models...

- GDM-35SL-RF-HC-LD standard with recessed handles; optional door locks available.



GDM® GLASS DOOR MERCHANDISER REFRIGERATORS

Model	# of Doors	# of Shelves	HP	Amps	Crated Weight lb. (kg.)	Cabinet Dimensions W D† H* (in)	Cabinet Dimensions W D† H* (mm)
SWING DOORS							
GDM-10-HC~TSL01	1	3	1/6	2.0	200 (91)	24 7/8 x 22 7/8 x 53 3/8	632 x 581 x 1356
GDM-10-58-HC~TSL01	1	3	1/6	2.0	210 (96)	24 7/8 x 22 7/8 x 58	630 x 581 x 1472
GDM-10SSL-HC~TSL01	1	3	1/6	2.0	170 (77)	24 7/8 x 18 x 53 1/2	632 x 458 x 1359
GDM-12-HC~TSL01	1	3	1/6	2.0	200 (91)	24 7/8 x 22 7/8 x 62 3/8	632 x 581 x 1585
GDM-15-RTO-HC-LD	1	5	1/6	2.0	250 (114)	24 7/8 x 24 3/8 x 75	632 x 626 x 1905
GDM-23-HC~TSL01	1	4	1/3	5.4	355 (161)	27 x 29 7/8 x 78 7/8	686 x 759 x 1998
GDM-26-HC~TSL01	1	5	1/3	5.4	325 (148)	30 x 29 7/8 x 78 5/8	762 x 759 x 1998
GDM-35-HC~TSL01	2	8	1/2	6.5	370 (168)	39 1/2 x 29 7/8 x 78 5/8	1004 x 759 x 1998
GDM-43-HC~TSL01	2	8	1/2	6.5	410 (186)	47 1/8 x 29 7/8 x 78 5/8	1197 x 759 x 1998
GDM-49-HC~TSL01	2	8	1/2	5.8	465 (211)	54 1/8 x 29 7/8 x 78 5/8	1375 x 759 x 1998
GDM-72-HC~TSL01	3	12	1/2	9.3	630 (286)	78 1/8 x 29 7/8 x 78 5/8	1985 x 759 x 1998
PASS-THRU SWING DOORS							
GDM-10PT-HC~TSL01	1 fr / 1 bk	3	1/6	2.2	225 (102)	24 7/8 x 25 1/2 x 53 3/8	630 x 648 x 1356
REAR-LOAD SWING DOORS							
GDM-49RL-HC~TSL01	2 fr / 2 bk	8	1/2	7.3	555 (252)	54 1/8 x 32 1/8 x 78 1/2	1372 x 814 x 1994
RADIUS FRONT SWING DOORS							
GDM-14RF-HC-LD	2	3	1/6	2.0	280 (127)	30 3/8 x 29 1/4 x 58	772 x 743 x 1474
GDM-35SL-RF-HC-LD	2	4	1/6	3.4	275 (125)	39 3/4 x 24 1/4 x 58 1/8	1010 x 616 x 1477

† Depth does not include 1 5/8" (42 mm) for door handles.

† Depth does not include 1 5/8" (42 mm) each side for door handles on GDM-10PT-HC~TSL01.

† Depth does not include 1" (26 mm) for rear bumper on GDM-10-HC~TSL01, GDM-10-58-HC~TSL01, GDM-10SSL-HC~TSL01 & GDM-12-HC~TSL01.

GDM® EXTERIOR OPTIONS

White



Stainless Steel*



GDM® INTERIOR OPTIONS

Stainless Steel*



Black*



note: For standard swing and slide door models only.

*Upcharges apply for Stainless Steel Exterior and Stainless Steel & Black Interiors. Contact Factory for more information.

Environmentally friendly R290 hydrocarbon refrigeration system for the best in food preservation.



GLASS DOOR FREEZER & ICE MERCHANTISERS

Swing Door



Positive seal self-closing doors

Standard backguard and floor rack improve airflow. "No-stoop" lower shelf

Adjustable, PVC-coated wire shelves



Exterior - non-peel or chip black powder coated cold rolled steel; durable and permanent. Available in White exterior at no extra charge

Capacity:
GDM-26NT-HC~TSL01 holds 54 eight pound bags
GDIM-49NT-HC~TSL01 holds 117 eight pound bags

Bottom mounted compressor can be easily serviced and accessed by a single repair tech

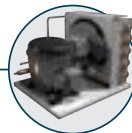

Allows for top storage



GDM-23F-HC~TSL01

GDIM-26NT-HC~TSL01



GDM-07F-HC~TSL01



GDM-12F-HC~TSL01



GDM-35F-HC~TSL01



GDIM-49NT-HC~TSL01

Features/Benefits

- Maintains cold -10°F (-23.3°C) product temperatures for storage of frozen food and ice cream.
 - Automatic defrost system time-initiated, temperature-terminated (GDM-07F-HC~TSL01 time-initiated, time-terminated).
 - Automatic evaporator fan motor delay during defrost cycle.
 - Large evaporator and coil heater permit short defrost cycle.
 - Interior - attractive, white aluminum with stainless steel floor.
 - LED interior lighting provides more even lighting throughout the cabinet. Safety shielded.
 - Energy efficient, triple pane, thermal insulated glass doors.
 - Illuminated sign panel included
 - See our website www.truemfg.com for the latest color & sign offerings.
 - Self-contained system, no plumbing required.
 - Available with optional legs or 2½" (64mm) diameter castors. (legs not available on GDM-10F-HC~TSL01 & GDM-12F-HC~TSL01; 2½" (64mm) castors not available on GDM-07F-HC~TSL01). GDM-07F-HC~TSL01 standard with 2½" (64mm) legs; leg levelers standard for all other models shown.
 - Optional black or stainless interiors available. Upcharge and lead times will apply.
 - Optional stainless exteriors available. Upcharge and lead times will apply.
- FLX models...**
- Easily converts from freezer to refrigerator with the flip of a switch.
- GDIM models have...**
- Holds 20°F to 25°F (-6.7°C to -3.9°C).
 - Anti-fog film adhered to the glass pane to minimize condensation build-up.
 - Minimum wattage heater in cabinet frame and doors.

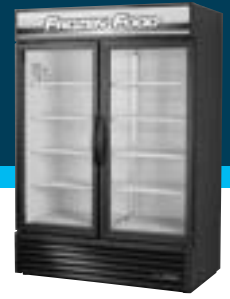

GDM® GLASS DOOR MERCHANDISER FREEZERS

Model	# of Doors	# of Shelves	HP	Amps	Crated Weight lb. (kg.)	Cabinet Dimensions W D† H* (in)	Cabinet Dimensions W D† H* (mm)
SWING DOORS							
GDM-07F-HC~TSL01	1	3	¼	2.8	195 (89)	24⅞ x 24⅞ x 39⅞	613 x 626 x 1013
GDM-10F-HC~TSL01	1	3	½	4.5	235 (107)	24⅞ x 22⅞ x 53⅞	632 x 581 x 1356
GDM-12F-HC~TSL01	1	3	½	4.5	255 (116)	24⅞ x 23⅞ x 62⅞	632 x 594 x 1585
GDM-23F-HC~TSL01	1	4	½	4.4	355 (162)	27 x 29⅞ x 78⅞	686 x 759 x 1998
GDM-26F-HC~TSL01	1	4	½	4.4	340 (155)	30 x 29⅞ x 78⅞	762 x 759 x 1998
GDM-35F~TSL01	2	8	¾	7.9	440 (200)	39½ x 29⅞ x 78⅞	1004 x 759 x 1998
GDM-43F-HC~TSL01	2	8	(2) ½	9.5	550 (250)	47⅞ x 29⅞ x 78⅞	1197 x 759 x 1998
GDM-49F-HC~TSL01	2	8	(2) ½	9.5	600 (273)	54⅞ x 29⅞ x 78⅞	1375 x 759 x 1998
GDM-72F-HC~TSL01	3	12	(2) ¾	15.1	850 (386)	78⅞ x 29⅞ x 78⅞	1985 x 759 x 1998

† Depth does not include 1⅞" (42mm) for door handle.

‡ Depth does not include 1" (26mm) for rear bumpers on GDM-10F-HC~TSL01 & GDM-12F-HC~TSL01.

note: GDM-49F-HC~TSL01 & GDM-72F-HC~TSL01 are completely pre-wired at the factory and are ready for final connection to a single 115/208-230/60Hz single phase, 20 amp dedicated circuit.

note: GDM-12F-HC-LD height does not include 1" (26mm) for door hinge.

GDIM GLASS DOOR ICE MERCHANDISER

Model	# of Doors	# of Shelves	HP	Amps	Crated Weight lb. (kg.)	Cabinet Dimensions W D† H* (in)	Cabinet Dimensions W D† H* (mm)
SWING DOORS							
GDIM-26NT-HC~TSL01	1	1	½	6.0	295 (134)	30 x 29⅞ x 78⅞	762 x 759 x 1998
GDIM-49NT-HC~TSL01	2	2	½	7.0	455 (207)	54⅞ x 29⅞ x 78⅞	1375 x 759 x 1998

† Depth does not include 1⅞" (35 mm) for door handles.

FLX GLASS DOOR CONVERTIBLE REFRIGERATOR/FREEZER

Model	# of Doors	# of Shelves	HP	Amps	Crated Weight lb. (kg.)	Cabinet Dimensions W D† H* (in)	Cabinet Dimensions W D† H* (mm)
GLASS DOORS							
GDM-26F-FLX-HC~TSL01	1	4	½	4.4	340 (155)	30 x 29⅞ x 78⅞	762 x 759 x 1998
GDM-43F-FLX-HC~TSL01	2	8	(2) ½	9.5	550 (250)	47⅞ x 29⅞ x 78⅞	1196 x 759 x 1998
GDM-49F-FLX-HC~TSL01	2	8	(2) ½	9.5	568 (258)	54⅞ x 29⅞ x 78⅞	1375 x 759 x 1998

† Depth does not include 1⅞" (42 mm) for door handles.



Environmentally friendly R290 hydrocarbon refrigeration system for the best in food preservation.



GLASS DOOR MERCHANDISER REFRIGERATORS

Slide Door



GDM-47-HC-LD



GDM-33-HC-LD



GDM-41-HC-LD



GDM-41SL-HC-LD



GDM-69-HC-LD

Features/Benefits

- Maintains cold 33°F to 38°F (0.5°C to 3.3°C) product temperatures.
 - Interior - attractive, white aluminum with stainless steel floor.
 - LED interior lighting provides more even lighting throughout the cabinet. Safety shielded.
 - Illuminated sign panel included
 - See our website www.truemfg.com for the latest color & sign offerings.
 - Self-contained system, no plumbing required.
 - Available with optional legs or 2½" (64mm) diameter castors.
 - Optional red wine, white wine, or chocolate thermostat available.
 - Optional black or stainless interiors available. Upcharge and lead times will apply.
 - Optional stainless exteriors available. Upcharge and lead times will apply.
 - Allows for top storage.
- Rear-Load Models...**
- GDM-47RL-HC~TSL01 rear doors are black powder coated solid swing doors with recessed handles.

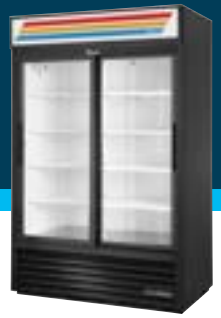

GDM® GLASS DOOR MERCHANDISER REFRIGERATORS

Model	# of Doors	# of Shelves	HP	Amps	Crated Weight lb. (kg.)	Cabinet Dimensions W D† H* (in)	Cabinet Dimensions W D† H* (mm)
SLIDE DOORS							
GDM-33-HC-LD	2	8	½	6.5	370 (168)	39½ x 29½ x 78½	1004 x 753 x 1998
GDM-41-HC-LD	2	8	½	3.9	405 (184)	47½ x 29½ x 78½	1197 x 753 x 1998
GDM-41SL-HC-LD	2	8	½	10.8	410 (186)	47½ x 24½ x 78½	1197 x 613 x 1998
GDM-47-HC-LD	2	8	½	8.5	485 (220)	54½ x 29½ x 78½	1376 x 757 x 1998
GDM-69-HC-LD	3	12	½	7.3	635 (289)	78½ x 29½ x 78½	1985 x 753 x 1998
REAR-LOAD SLIDE DOORS							
GDM-47RL-HC-LD	2 fr / 2 bk	8	½	8.5	535 (243)	54½ x 32½ x 78½	1372 x 816 x 1998

† Depth does not include ¾" (10 mm) for door handles.

Environmentally friendly R290 hydrocarbon refrigeration system for the best in food preservation.



GLASS DOOR MERCHANDISER CONVENIENCE STORE & COUNTER-TOP REFRIGERATORS

Swing & Slide Door

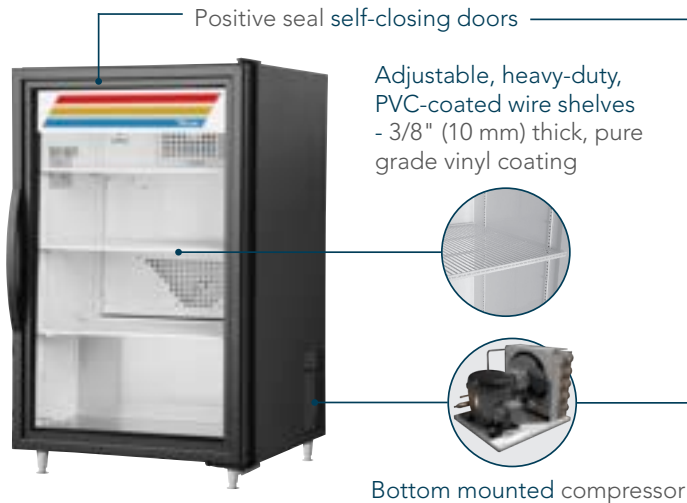

GDM-07-HC-TSL01



GDM-41CPT-48-HC-LD



GDM-05-HC-TSL01



GDM-33CPT-54-HC-LD



GDM-10SSL-HC-TSL01



GDM-33SSL-56-HC-LD

Features/Benefits

Convenience Store models have...

- Maintains cold 33°F to 38°F (0.5°C to 3.3°C) product temperatures.
- Lower and narrow profile convenience store coolers allow extra visibility throughout store. Makes gondola and center store placement possible.
- Interior - attractive, white aluminum with stainless steel floor.
- LED interior lighting provides more even lighting throughout the cabinet. Safety shielded.
- Energy efficient, "Low-E", thermal insulated glass.
- Door decal included.
- See our website www.truemfg.com for the latest color & sign offerings.
- Available with optional legs or 2½" (64mm) diameter castors. GDM-06-34-HC-TSL01, GDM-10-HC-TSL01, GDM-10SSL-HC-TSL01, GDM-10PT-HC-TSL01 & GDM-12-HC-TSL01 available with optional 2½" (64mm) diameter castors only.
- Self-contained system, no plumbing required.
- Optional black interiors available. Upcharge and lead times will apply.
- Optional stainless exteriors available. Upcharge and lead times will apply.

Counter-Top models have...

- Maintains cold 33°F to 38°F (0.5°C to 3.3°C) product temperatures.
- Designed for convenient access, fast service, and attractive display.
- Interior - attractive, white aluminum with stainless steel floor.
- LED interior lighting provides more even lighting throughout the cabinet. Safety shielded.
- Energy efficient, "Low-E", thermal insulated glass.
- Illuminated sign panel - "True Stripe" standard (decal on GDM-07/07-S-HC-TSL01).
- See our website www.truemfg.com for the latest color & sign offerings.
- Energy efficient - no heater wires or electric condensate pans are required that offset refrigeration.
- GDM-07/7-S-HC-TSL01 are standard with 2½" (64mm) legs; leg levelers standard for all other models shown.
- GDM-05/05-S/05PT/05PT-S-HC-TSL01 & GDM-07/7-S-HC-TSL01 available with optional 4" legs. GDM-06-34-HC-TSL01 available with optional 2½" (64mm) castors.
- Self-contained system, no plumbing required.
- Optional black interiors available. Upcharge and lead times will apply.



GDM® GLASS DOOR MERCHANDISER CONVENIENCE STORE REFRIGERATORS

Model	# of Doors	# of Shelves	HP	Amps	Crated Weight lb. (kg.)	Cabinet Dimensions W D† H* (in)	Cabinet Dimensions W D† H* (mm)
LOWER HEIGHT & STANDARD DEPTH SLIDE DOORS							
GDM-41C-48-HC-LD	2	6	½	3.4	325 (148)	48 x 24½ x 48	1220 x 613 x 1220
LOWER HEIGHT & NARROW DEPTH SLIDE DOORS							
GDM-33SSL-56-HC-LD	2	4	½	3.0	235 (107)	36 x 18 x 56	915 x 458 x 1423
GDM-41SL-48-HC-LD	2	6	¼	3.4	295 (134)	46⅞ x 21 x 47¾	1191 x 534 x 1213
GDM-41SL-54-HC-LD	2	6	¼	3.8	295 (134)	47⅞ x 21 x 54⅞	1197 x 534 x 1375
GDM-41SL-60-HC-LD	2	6	½	3.8	345 (157)	47⅞ x 21 x 59⅞	1197 x 534 x 1521
LOWER HEIGHT & NARROW DEPTH, FAST LANE, PASS-THRU SLIDE DOORS							
GDM-33CPT-54-HC-LD	2 fr / 2 bk	3	½	2.0	360 (164)	39½ x 24½ x 54⅞	1004 x 613 x 1375
GDM-41CPT-48-HC-LD	2 fr / 2 bk	6	½	2.0	394 (179)	48 x 24½ x 48	1220 x 613 x 1220
LOWER HEIGHT – END OF AISLE MERCHANDISER							
GDM-08-HC~TSL01	1	3	½	1.7	180 (82)	23½ x 23 x 48	594 x 583 x 1219
GDM-10-HC~TSL01	1	3	½	2.0	200 (91)	24⅞ x 22⅞ x 53⅞	632 x 581 x 1356
GDM-10SSL-HC~TSL01	1	3	½	2.0	170 (77)	24⅞ x 18 x 53½	632 x 458 x 1359
GDM-10PT-HC~TSL01	1 fr / 1 bk	3	½	2.2	225 (102)	24⅞ x 25½ x 53⅞	630 x 648 x 1356

† Depth does not include 1⅞" (35mm) for handle on swing door models, (GDM-10PT-HC~TSL01 has handles front & back); or ⅞" (23mm) on slide door models (GDM-33CPT~TSL01 & GDM-33CPT-54~TSL01 has handles front and back).

† Depth does not include 1" (26mm) for rear bumpers on GDM-10-HC~TSL01 & GDM-10SSL~TSL01.

GDM® GLASS DOOR MERCHANDISER COUNTER-TOP REFRIGERATORS

Model	# of Doors	# of Shelves	HP	Amps	Crated Weight lb. (kg.)	Cabinet Dimensions W D† H* (in)	Cabinet Dimensions W D† H* (mm)
BLACK EXTERIOR SWING DOORS							
GDM-05-HC~TSL01	1	2	½	2.7	155 (71)	24 x 23⅞ x 36¼	608 x 592 x 919
GDM-06-34-HC~TSL01	1	3	⅓	1.6	175 (80)	20½ x 26⅞ x 33½	519 x 670 x 850
GDM-07-HC~TSL01	1	3	½	1.9	180 (82)	24⅞ x 24⅞ x 39⅞	613 x 626 x 1013
GDM-08-HC~TSL01	1	3	½	1.7	180 (82)	23½ x 23 x 48	594 x 583 x 1219
GDM-09-SQ-HC-LD	2	3	½	1.9	230 (105)	36 x 22⅞ x 40	913 x 567 x 1014
BLACK EXTERIOR SWING DOORS FRAMED GLASS							
GDM-05-HC~FGD01	1	2	½	2.7	155 (71)	24 x 23⅞ x 36¼	608 x 592 x 919
STAINLESS STEEL EXTERIOR SWING DOORS							
GDM-05-S-HC~TSL01	1	2	½	2.7	155 (71)	24 x 23⅞ x 36¼	608 x 592 x 919
GDM-07-S-HC~TSL01	1	3	½	1.9	195 (89)	24⅞ x 24⅞ x 39⅞	613 x 626 x 1013
GDM-09-SQ-S-HC-LD	2	3	½	1.9	230 (105)	36 x 22⅞ x 40	913 x 567 x 1014
STAINLESS STEEL EXTERIOR SWING DOORS FRAMED GLASS							
GDM-05-S-HC~FGD01	1	2	½	2.7	155 (71)	24 x 23⅞ x 36¼	608 x 592 x 919
PASS-THRU BLACK EXTERIOR SWING DOORS							
GDM-05PT-HC~TSL01	1 fr / 1 bk	2	½	2.7	165 (75)	24 x 23⅞ x 36¼	608 x 600 x 919
PASS-THRU STAINLESS STEEL EXTERIOR SWING DOORS							
GDM-05PT-S-HC~TSL01	1 fr / 1 bk	2	½	2.7	165 (75)	24 x 23⅞ x 36¼	608 x 600 x 919
BLACK EXTERIOR SWING DOORS EXTENDED TOP							
GDM-06-34-HC~TSL01-EXT TOP	1	3	½	1.6	175 (80)	20¾ x 26⅞ x 33⅞	525 x 671 x 852
STAINLESS STEEL EXTERIOR SLIDE DOORS							
TSD-09G-HC-LD	2	3	½	1.9	220 (100)	36 x 21 x 35⅞	913 x 532 x 911

† Depth does not include 1⅞" (42mm) for handle on swing door models (GDM-05PT-HC~TSL01/05PT-S-HC~TSL01 (front and back) or ¾" (20mm) on slide door models.

Environmentally friendly R290 hydrocarbon refrigeration system for the best in food preservation.



GLASS END & GLASS FOUR SIDED MERCHANDISERS

Swing Door

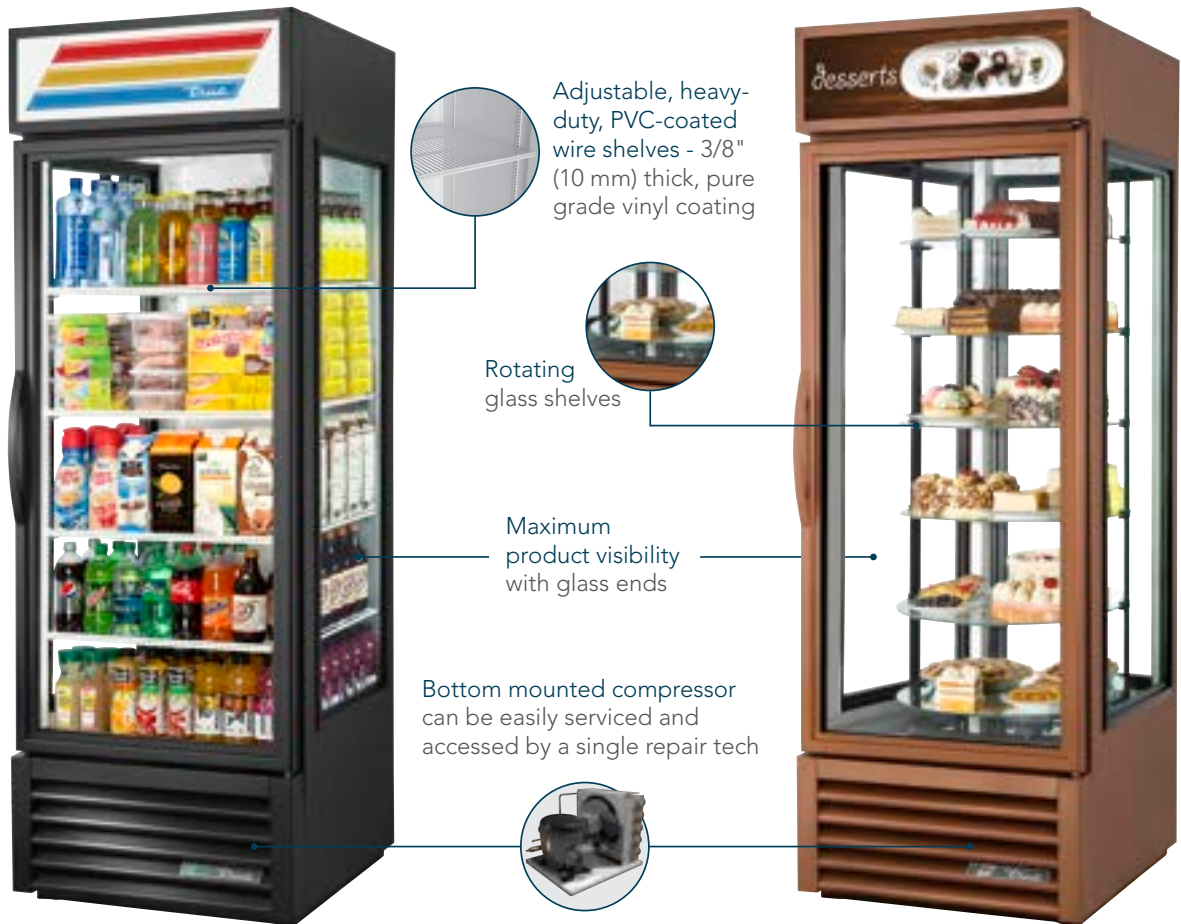

GEM-23-HC~TSL01

G4SM-23RGS~TSL01

Features/Benefits

- Maintains cold 33°F to 38°F (0.5°C to 3.3°C) product temperatures.
 - G4SM: Exterior - attractive, high-luster copper powder coated finish. Available in Black or White exterior at no extra charge.
 - Interior - attractive, white aluminum with stainless steel floor.
 - LED interior lighting provides more even lighting throughout the cabinet. Safety shielded.
 - Energy efficient, "Low-E", thermal insulated glass.
 - Illuminated 4-color process sign panel included.
 - See our website www.truemfg.com for the latest color & sign offerings.
 - Self-contained system, no plumbing required.
 - Allows for top storage.
 - "No-stoop", lower shelf.
 - Optional black interiors available. Upcharge and lead times will apply.
 - Optional stainless exteriors available. Upcharge and lead times will apply.
- Glass End Merchandiser models have...**
- Exterior - durable and permanent non-peel or chip black powder coated cold rolled steel. Available in White exterior at no extra charge.
 - Optional black interiors available. Upcharge and lead times will apply.



GEM GLASS END MERCHANDISERS

Model	# of Doors	# of Shelves	HP	Amps	Crated Weight lb. (kg.)	Cabinet Dimensions W D† H* (in)	Cabinet Dimensions W D† H* (mm)
SWING DOORS							
GEM-23-HC~TSL01	1	4	1/3	5.4	335 (152)	27½ x 29¾ x 78¾	699 x 759 x 1998

† Depth does not include 1¾" (35mm) for door handle on swing door models.

G4SM GLASS FOUR SIDED MERCHANDISER REFRIGERATORS

Model	# of Doors	# of Shelves	HP	Amps	Crated Weight lb. (kg.)	Cabinet Dimensions W D† H* (in)	Cabinet Dimensions W D† H* (mm)
SWING DOORS							
G4SM-23-HC~TSL01	1	4	1/3	5.4	355 (162)	27½ x 30¾ x 78¾	699 x 766 x 1998
G4SM-23PT-HC~TSL01	2	4	1/3	5.4	375 (171)	27½ x 32¾ x 78¾	699 x 832 x 1998
ROTATING GLASS SHELF							
G4SM-23RGS~TSL01	1	6	1/4	2.4	385 (175)	27½ x 30¾ x 78¾	699 x 766 x 1998

† Depth does not include 1¾" (35mm) for door handles (rear load and pass thru's have handles front and back).
 note: G4SM-23RGS~TSL01 has five glass shelves and one mirrored shelf (positioned on bottom).

Environmentally friendly R290 hydrocarbon refrigeration system for the best in food preservation.



*Oversized and balanced, environmentally-friendly (134A) refrigeration on G4SM-23RGS~TSL01.

GLASS DOOR & GLASS FOUR SIDED FLORAL CASES

Swing & Slide Doors



GDM-23FC-HC~TSL01



GDM-12FC-HC~TSL01



G4SM-23FC-HC~TSL01



GDM-47FC-HC-LD



GDM-69FC-HC-LD

Features/Benefits

- Designed to hold 35°F (1.7°C).
- Exterior - non-peel or chip black powder coated cold rolled steel; durable and permanent. Available in White exterior at no extra charge.
- Interior - attractive, black aluminum for vivid contrast and dramatic display of flowers. Non peel or chip interior - stainless steel floor.
- Baffled airflow - blossom supporting, correct temperature and humidity for longer shelf life of fresh flowers.
- LED interior lighting provides more even lighting throughout the cabinet. Safety shielded.
- Energy efficient, "Low-E", thermal insulated glass.
- Mirrored interior backs available.
- Illuminated sign panel included (decals on GDM-10-HC~TSL01,

- GDM-10-58-HC~TSL01, GDM-10SSL-HC~TSL01, GDM-10PT-HC~TSL01 & GDM-12-HC~TSL01).
- See our website www.truemfg.com for the latest color & sign offerings.
- Self-contained system, no plumbing required.
- Available with optional legs or 2½" (64mm) diameter castors. GDM-12FC-HC~TSL01 available with optional 2½" (64mm) diameter castors only.
- Allows for top storage.
- Optional stainless interiors available. Upcharge and lead times will apply.
- Optional stainless exteriors available. Upcharge and lead times will apply.
- Optional copper exterior available on G4SM-23FC-HC~TSL01 only.



GDM® GLASS DOOR MERCHANDISER FLORAL CASES

Model	# of Doors	# of Shelves	HP	Amps	Crated Weight lb. (kg.)	Cabinet Dimensions W D† H* (in)	Cabinet Dimensions W D† H* (mm)
SWING DOORS							
GDM-12FC-HC~TSL01	1	2	1/6	2.0	225 (106)	24 7/8 x 23 1/8 x 62 3/8	632 x 588 x 1585
GDM-23FC-HC~TSL01	1	2	1/3	5.4	300 (137)	27 x 29 7/8 x 78 5/8	686 x 759 x 1998
GDM-49FC-HC~TSL01	2	4	1/2	4.9	465 (211)	54 1/8 x 29 7/8 x 78 5/8	1375 x 759 x 1998
GDM-72FC-HC~TSL01	3	6	1/2	9.3	630 (286)	78 1/8 x 29 7/8 x 78 5/8	1985 x 759 x 1998
SLIDE DOORS							
GDM-47-FC-LD	2	4	1/2	8.5	470 (214)	54 1/8 x 29 7/8 x 78 5/8	1375 x 753 x 1998
GDM-69-FC-HC-LD	3	6	1/2	7.3	645 (293)	78 1/8 x 29 7/8 x 78 5/8	1985 x 753 x 1998

† Depth does not include 1 3/8" (42mm) for door handle on swing door models; or 3/8" (10mm) for slide door models.

† Depth does not include 1" (26mm) for rear bumpers on GDM-12FC-HC~TSL01.

G4SM GLASS FOUR SIDED MERCHANDISER FLORAL CASES

Model	# of Doors	# of Shelves	HP	Amps	Crated Weight lb. (kg.)	Cabinet Dimensions W D† H* (in)	Cabinet Dimensions W D† H* (mm)
SWING DOORS							
G4SM-23FC-HC~TSL01	1	2	1/3	5.4	375 (171)	27 1/2 x 30 1/8 x 78 5/8	699 x 766 x 1998

† Depth does not include 1 3/8" (42mm) for door handle.

Environmentally friendly R290 hydrocarbon refrigeration system for the best in food preservation.



GLASS DOOR WINE MERCHANDISERS

Swing & Slide Doors



GDM-23W-HC~TSL01

Features/Benefits

- Designed to hold 33°F to 38°F (0.5°C to 3.3°C).
- Exterior - non-peel or chip black powder coated cold rolled steel; durable and permanent. Available in White exterior at no extra charge.
- Interior - attractive, black aluminum for vivid contrast and dramatic display of flowers. Non peel or chip interior - stainless steel floor.
- Standard with mirrored back.
- LED interior lighting provides more even lighting throughout the cabinet. Safety shielded.
- Energy efficient, "Low-E", thermal insulated glass.
- Illuminated sign panel included.
- GDM-23W-HC~TSL01 is standard with locks.
- See our website www.truemfg.com for the latest color & sign offerings.
- Self-contained system, no plumbing required.
- Available with optional legs or 2½" (64mm) diameter castors.
- Optional red wine, white wine, or chocolate wine thermostat available.
- Optional stainless interiors available. Upcharge and lead times will apply.
- Optional stainless and copper exteriors available. Upcharge and lead times will apply.

GDM® GLASS DOOR WINE MERCHANDISERS

Model	# of Doors	# of Shelves*	HP	Amps	Crated Weight lb. (kg.)	Cabinet Dimensions W D† H (in)	Cabinet Dimensions W D† H* (mm)
SWING DOORS							
GDM-23W-HC~TSL01	1	5	1/3	5.4	310 (141)	27 x 29 7/8 x 78 5/8	686 x 759 x 1998

† Depth does not include 1 5/8" (42mm) for door handle.

* Shelves include 4 wine shelves and 1 wire shelf.

Environmentally friendly R290 hydrocarbon refrigeration system for the best in food preservation.



GLASS DOOR MERCHANDISER WITH HEALTH SAFETY TIMER *Swing Doors*

Health Safety Timer.
Once the sensor in the cabinet senses that 41°F (5°C) has been exceeded for a continuous 30 minutes, the cabinet door will lock, the display will indicate HST LCK, and the LAE control will beep until silenced



Adjustable, heavy-duty, PVC-coated wire shelves - 3/8" (10 mm) thick, pure grade vinyl coating

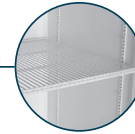

Exterior digital temperature control and display



Bottom mounted compressor can be easily serviced and accessed by a single repair tech

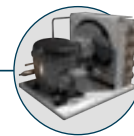

GDM-26-HST02-HC~TSL01



GDM-26-HST02-HC-TSL01



GDM-23F-HST-HC-TSL01

Features/Benefits

- Maintains cold 33°F to 38°F (0.5°C to 3.3°C) product temperatures.
- Exterior - non-peel or chip black powder coated cold rolled steel; durable and permanent. Available in White exterior at no extra charge.
- Interior - attractive, white aluminum with stainless steel floor.
- LED interior lighting provides more even lighting throughout the cabinet. Safety shielded.
- Positive seal self-closing swing doors.
- Energy efficient, "Low-E", thermal insulated glass.
- Self-contained system, no plumbing required.
- Illuminated sign panel included
- See our website www.truemfg.com for the latest color & sign offerings.
- Available with optional legs or 2½" (64mm) diameter castors.
- Optional black or stainless interiors available. Upcharge and lead times will apply.

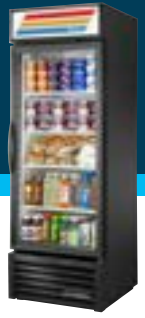

GDM® GLASS DOOR MERCHANDISER WITH HEALTH SAFETY TIMER

Model	# of Doors	# of Shelves	HP	Amps	Crated Weight lb. (kg.)	Cabinet Dimensions W D† H* (in)	Cabinet Dimensions W D† H* (mm)
SWING DOORS REFRIGERATORS							
GDM-23-HST02-HC~TSL01	1	4	1/3	2.6	295 (134)	27 1/4 x 29 3/4 x 78 1/2	691 x 754 x 1994
GDM-26-HST02-HC~TSL01	1	5	1/3	5.4	320 (145)	30 1/4 x 29 3/4 x 78 1/2	762 x 754 x 1998
SWING DOORS FREEZERS							
GDM-23F-HST-HC~TSL01	1	4	1	9.5	380 (173)	27 x 29 7/8 x 78 5/8	686 x 759 x 1998
GDM-26F-HST-HC~TSL01	1	4	1	9.5	390 (177)	30 x 29 7/8 x 78 5/8	762 x 759 x 1998

† Depth does not include 1 3/8" (42mm) for door handles.



An electronic monitoring system deploys lock if unsafe temperatures last longer than the allotted time.

IMPROVED! The Low Profile integrated lock design allows the cabinet to be built-in or banked next to other cabinets. The (HST) locking system can be unlocked and locked with a password through the electronic temperature control display.

HST02 MODELS ONLY



The Door Lock is activated if temperatures rise over 41°F (5°C) for 30 minutes (refrigerators). 0°F (-18°C) for 30 minutes (freezers).



Battery backup power supply ensures the lock will continue to function during loss of power.



Audible alarm sounds, along with a visual signal display when lock is triggered to inform staff.



IMPROVED! Door locks immediately upon power failure unless otherwise programmed.

HST02 MODELS ONLY



PLEASE NOTE: Improved features of the HST02 models are available at this time on refrigerator versions only. Freezer versions (shown left) still come with original controls and HST locking mechanism. Please contact factory for details.

Environmentally friendly R290 hydrocarbon refrigeration system for the best in food preservation.



GLASS DOOR VISUAL MERCHANDISER REFRIGERATORS

Swing Doors



TVM-30-HC~VM03



TVM-48SL-48-HC-VM01



TVM-48SL-54-HC-VM01



TVM-36SL-HC-VM01



TVM-48SL-HC-VM01

Features/Benefits

- Refrigerators maintain cold 33°F to 38°F (0.5°C to 3.3°C) product temperatures.
- True Visual Merchandisers are ideal for in-aisle and end cap refrigeration applications. The improved low profile swing door design eliminates the center mullion. This allows for full product visibility and ease of shopping. The hydrocarbon refrigeration system will save on energy costs compared to that of open air refrigerators found in similar scenarios.
- Exterior - non-peel or chip black powder coated cold rolled steel; durable and permanent. Available in White exterior at no extra charge.
- Interior - attractive, white aluminum with stainless steel floor.
- LED interior lighting provides more even lighting throughout the cabinet. Safety shielded.
- Positive seal self-closing swing doors.
- Self-contained system, no plumbing required.
- Illuminated sign panel included (decal on TVM-30-HC~VM01, TVM-36SL-HC~VM01, TVM-48SL-48-HC~VM01 & TVM-48SL-54-HC~VM01).
- See our website www.truemfg.com for the latest color & sign offerings.
- Available with optional legs or 2½" (64mm) diameter castors.
- Optional black or stainless interiors available. Upcharge and lead times will apply.
- Optional stainless exteriors available. Upcharge and lead times will apply.

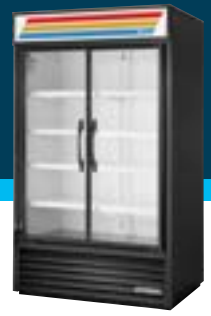

TVM® GLASS DOOR VISUAL MERCHANDISER REFRIGERATORS

Model	# of Doors	# of Shelves	HP	Amps	Crated Weight lb. (kg.)	Cabinet Dimensions W D† H* (in)	Cabinet Dimensions W D† H* (mm)
SWING DOORS							
TVM-30-HC~VM03	2	4	1/5	2.0	255 (116)	307/8 x 24 x 547/8	783 x 608 x 1393
TVM-30SL-HC~VM03	2	4	1/5	2.0	245 (111)	307/8 x 213/8 x 547/8	783 x 540 x 1393
TVM-36SL-HC~VM03	2	4	1/4	2.0	260 (118)	36 x 213/8 x 547/8	914 x 540 x 1393
TVM-48-HC~VM01	2	8	1/2	10.5	520 (236)	471/4 x 297/8 x 785/8	1198 x 757 x 1996
TVM-48SL-HC~VM01	2	8	1/2	10.8	575 (261)	477/8 x 251/4 x 783/4	1197 x 641 x 2000
TVM-48SL-48-HC~VM01	2	6	1/5	2.0	315 (143)	467/8 x 21 x 48	1190 x 533 x 1217
TVM-48SL-54-HC~VM01	2	6	1/4	2.0	380 (173)	477/8 x 21 x 537/8	1197 x 533 x 1368

† Depth does not include 1 3/4" (45mm) for door handles.

† Depth does not include 1" (26mm) for rear bumpers.

Low profile swing door design eliminates the center mullion, allowing for full product visibility and ease of shopping.



Environmentally friendly R290 hydrocarbon refrigeration system for the best in food preservation.



FULL LENGTH MERCHANDISER REFRIGERATORS & FREEZERS Swing Doors

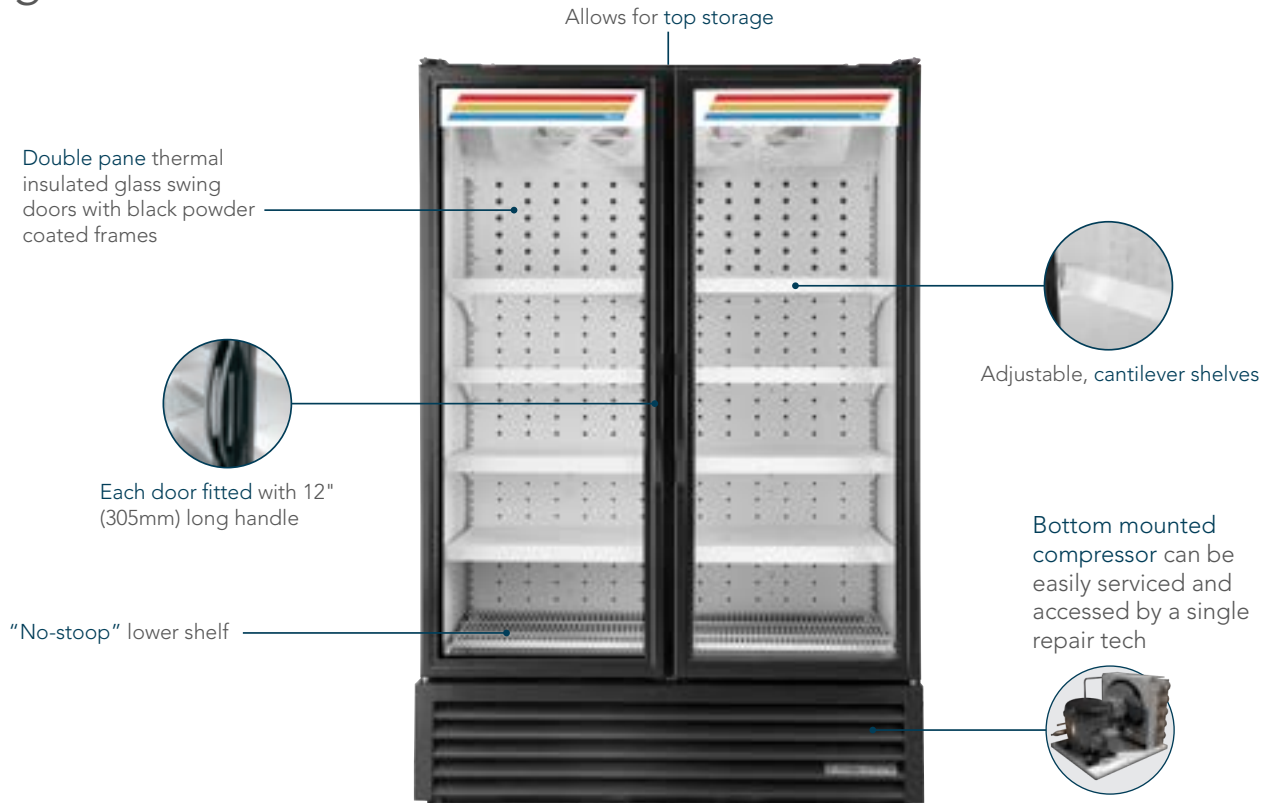

FLM-54~TSL01



FLM-27~TSL01



FLM-54~TSL01



FLM-81~TSL01

Features/Benefits

- Refrigerators maintain cold 33°F to 38°F (0.5°C to 3.3°C) product temperatures. Freezers maintain cold -10°F (-23.3°C) product temperatures for storage of frozen food and ice cream.
- True Full Length merchandisers feature full height doors for maximum product visibility and have endless case look with a self-contained system.
- Exterior - non-peel or chip black powder coated cold rolled steel; durable and permanent. Available in White exterior at no extra charge.
- Interior - attractive, white aluminum with stainless steel floor.
- LED interior lighting provides more even lighting throughout the cabinet. Safety shielded.
- Positive seal self-closing swing doors.
- Self-contained system, no plumbing required.
- Door sign decal. Variety of decal options available.
- See our website www.truemfg.com for the latest color & sign offerings.
- Optional black or stainless interiors available. Upcharge and lead times will apply.
- Optional stainless exteriors available. Upcharge and lead times will apply.



FLM™ FULL LENGTH MERCHANDISER REFRIGERATORS & FREEZERS

Model	# of Doors	# of Shelves	HP	Amps	Crated Weight lb. (kg.)	Cabinet Dimensions W D† H* (in)	Cabinet Dimensions W D† H* (mm)
SWING DOORS REFRIGERATORS							
FLM-27~TSL01	1	4	¼	2.3	355 (161)	27 x 30¾ x 79	686 x 772 x 2007
FLM-54~TSL01	2	8	½	6.3	625 (284)	53¾ x 30¾ x 79	1369 x 772 x 2007
FLM-81~TSL01	3	12	¾	6.3	810 (368)	80¾ x 30¾ x 79	2051 x 772 x 2007
SWING DOORS FREEZERS							
FLM-27F~TSL01	1	4	¾	7.2	385 (175)	27 x 30¾ x 79	686 x 772 x 2007
FLM-54F~TSL01	2	8	½	13.1	725 (329)	53¾ x 30¾ x 79	1369 x 772 x 2007
FLM-81F~TSL01	3	12	¾	14.2	870 (395)	80¾ x 30¾ x 79	2051 x 772 x 2007

† Depth does not include 1½" (42mm) for door handles.

Bankable Units to Create Seamless Look

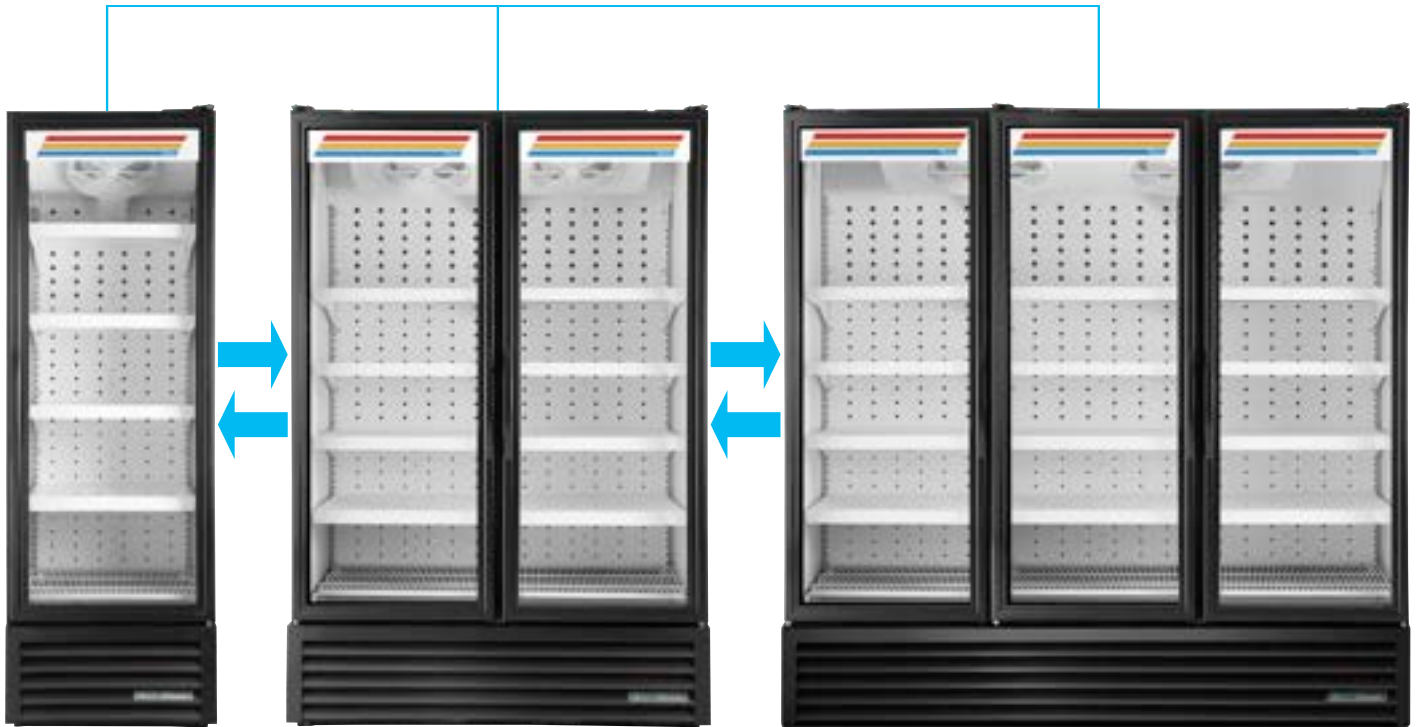



OPEN AIR MERCHANTISERS

Air curtain refrigerators combine large, open-front product displays aimed at maximum attention on merchandising and allow easy access to displayed products resulting in high-impulse sales. These open-air units also provide Industry-leading energy efficiency, durable construction, and dependability in the highest foot-traffic retail spaces.

GRAB-N



OPEN AIR MERCHANDISERS

Solid & Glass Sided



Adjustable, solid white powder coated cantilever shelves. Each shelf equipped with an LED light strip to provide 5 levels of even lighting throughout the cabinet. Cantilever shelving adjustable up to a 15° tilt

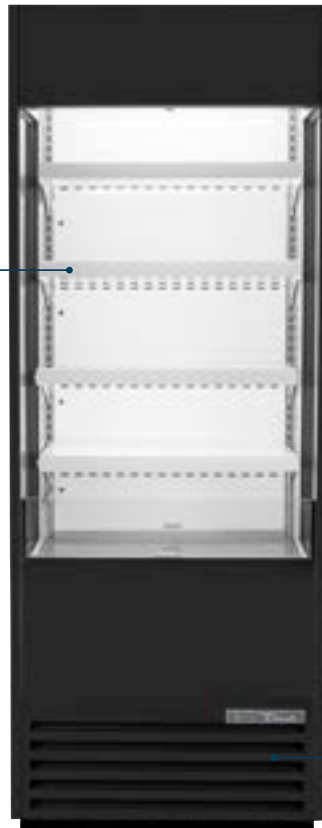

GS Models have glass side panels for maximum product visibility

Bottom mounted compressor can be easily serviced and accessed by a single repair tech

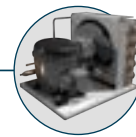

TOAM-30GS-HC~NSL01



TOAM-30GS-HC-TSL01
(with night cover)



TOAM-30-HC-NSL01



TOAM-48-HC-TSL01



TOAM-72GS-HC-NSL01

Features/Benefits

- Maintain cold 33°F to 40°F (0.5°C to 4.4°C) product temperatures.
- Large, open front allows easy access to display levels and places maximum attention on merchandising.
- Exterior - non-peel or chip black powder coated cold rolled steel; durable and permanent.
- Interior - attractive, white aluminum interior liner with stainless steel floor.
- Glass lower front panels.
- LED interior lighting provides more even lighting throughout the cabinet. Safety shielded.
- Illuminated exterior flat profile sign panel included on TSL01 models.
- See our website www.truefmfg.com for the latest color & sign offerings.
- Frame rail fitted with leg levelers. Available with optional legs, 2½" (64mm) diameter castors, 4" (102mm) castors, and 5" (127mm) castors.
- Standard with night cover.
- Optional black or stainless interiors available. Upcharge and lead times will apply.
- Optional stainless exteriors available. Upcharge and lead times will apply.
- Drain plumbing hookup recommended. Factory installed condensate pan heater kit available.



TOAM® OPEN AIR MERCHANDISERS

Model	# of Shelves	HP	Amps	Crated Weight lb. (kg.)	Cabinet Dimensions W D† H* (in)	Cabinet Dimensions W D† H* (mm)
BLACK EXTERIOR						
TOAM-30-HC~TSL01	4	¾	9.5	365 (166)	30 x 29½ x 78½	762 x 757 x 1994
TOAM-36-HC~TSL01	4	¾	10.2	390 (177)	36 x 29½ x 78½	915 x 757 x 1994
TOAM-48-HC~TSL01 ‡	4	(2) ¾	7.6	540 (245)	48 x 29½ x 78½	1220 x 757 x 1994
TOAM-60-HC~TSL01 ‡	4	(2) ¾	7.4	580 (263)	60 x 29½ x 78½	1524 x 757 x 1994
TOAM-72-HC~TSL01 ≠	8	(3) ¾	14.9	750 (340)	72 x 29½ x 78½	1829 x 757 x 1994
BLACK EXTERIOR~NON STANDARD LOOK						
TOAM-30-HC~NSL01	4	¾	9.5	365 (166)	30 x 29½ x 78½	762 x 738 x 1994
TOAM-36-HC~NSL01	4	¾	10.2	390 (177)	36 x 29½ x 78½	915 x 738 x 1994
TOAM-48-HC~NSL01 ‡	4	(2) ¾	7.6	540 (245)	48 x 29½ x 78½	1220 x 738 x 1994
TOAM-60-HC~NSL01 ‡	4	(2) ¾	7.4	580 (263)	60 x 29½ x 78½	1524 x 738 x 1994
TOAM-72-HC~NSL01 ≠	8	(3) ¾	14.9	750 (340)	72 x 29½ x 78½	1829 x 738 x 1994

‡ Requires 208-230/60 Hz, single phase, NEMA 6-15R.

≠ Requires 208-230/60 Hz, single phase, NEMA 6-20R.

TOAM® OPEN AIR MERCHANDISERS WITH GLASS SIDES

Model	# of Shelves	HP	Amps	Crated Weight lb. (kg.)	Cabinet Dimensions W D† H* (in)	Cabinet Dimensions W D† H* (mm)
BLACK EXTERIOR						
TOAM-30GS-HC~TSL01	4	¾	9.5	390 (177)	30 x 29½ x 78½	762 x 757 x 1994
TOAM-36GS-HC~TSL01	4	¾	10.2	390 (177)	36 x 29½ x 78½	915 x 757 x 1994
TOAM-48GS-HC~TSL01 ‡	4	(2) ¾	7.6	540 (245)	48 x 29½ x 78½	1220 x 757 x 1994
TOAM-60-HC~TSL01 ‡	4	(2) ¾	7.4	580 (263)	60 x 29½ x 78½	1524 x 757 x 1994
TOAM-72GS-HC~TSL01 ≠	8	(3) ¾	14.9	765 (347)	72 x 29½ x 78½	1829 x 757 x 1994
BLACK EXTERIOR~NON STANDARD LOOK						
TOAM-30GS-HC~NSL01	4	¾	9.5	390 (177)	30 x 29½ x 78½	762 x 738 x 1994
TOAM-36GS-HC~NSL01	4	¾	10.2	390 (177)	36 x 29½ x 78½	915 x 738 x 1994
TOAM-48GS-HC~NSL01 ‡	4	(2) ¾	7.6	540 (245)	48 x 29½ x 78½	1220 x 738 x 1994
TOAM-60-HC~NSL01 ‡	4	(2) ¾	7.4	580 (263)	60 x 29½ x 78½	1524 x 738 x 1994
TOAM-72GS-HC~NSL01 ≠	8	(3) ¾	14.9	765 (347)	72 x 29½ x 78½	1829 x 738 x 1994

‡ Requires 208-230/60 Hz, single phase, NEMA 6-15R.

≠ Requires 208-230/60 Hz, single phase, NEMA 6-20R.

Recommended Operating Conditions

- Designed to operate in an environment where temperature and humidity do not exceed 75°F (24°C) and 55% relative humidity.
- Units should not be installed near HVAC vents, fans or doorways that will disrupt the air curtain and compromise the function of the cabinet. Units should not be installed in direct sunlight.
- Models will run most efficiently when completely loaded with product.
- Drain plumbing hookup recommended. Factory installed condensate pan heater kit available if there is no access to drain plumbing.
- Please be advised Open Air Merchandisers are substantially louder than standard refrigeration models.

Environmentally friendly R290 hydrocarbon refrigeration system for the best in food preservation.



AIR CURTAIN MERCHANDISERS

Vertical & Horizontal, Solid & Glass Sided



Adjustable, heavy-duty, PVC-coated wire shelves - 3/8" (10mm) thick, pure grade vinyl coating

Bottom mounted compressor can be easily serviced and accessed by a single repair tech



Three (3) level tiered stainless steel floor.



TAC-14GS-HC-LD

THAC-36-HC-LD



THAC-48S-HC-LD



THAC-60-HC-LD (White Exterior)



THAC-60-HC-LD

Features/Benefits

TAC-14GS-HC-LD model has...

- Holds 35°F to 40°F (1.6°C to 4.4°C) product temperatures.
- Exterior - non-peel or chip black powder coated cold rolled steel; durable and permanent. Available in White exterior at no extra charge.
- Interior - attractive, white aluminum with stainless steel floor and deck pans. Available with black aluminum interior (upcharge applies); standard with black shelves.
- Optional organizers for 8 oz., 10 oz. & 12 oz. bottles.
- LED interior lighting provides more even lighting throughout the cabinet. Safety shielded.
- Leg levelers standard. Available with optional 4" (102mm) castors.
- Self-contained system.

THAC models have...

- Holds 35°F to 40°F (1.6°C to 4.4°C) product temperatures.
- Exterior - non-peel or chip black powder coated cold rolled steel; durable and permanent. Available in White exterior at no extra charge. Stainless steel exterior available (upcharge applies).
- Interior - attractive, exterior matching aluminum liner with stainless steel floor.
- LED interior lighting provides more even lighting throughout the cabinet. Safety shielded.
- Leg levelers standard.
- Self-contained system.



TAC® VERTICAL AIR CURTAIN MERCHANDISERS WITH GLASS SIDES

Model	# of Shelves	HP	Amps	Crated Weight lb. (kg.)	Cabinet Dimensions W* D† H (in)	Cabinet Dimensions W* D† H (mm)
BLACK EXTERIOR						
TAC-14GS-HC-LD	3	¾	7.0	280 (127)	30¼ x 32½ x 56¾	769 x 816 x 1432

THAC™ HORIZONTAL AIR CURTAIN MERCHANDISERS

Model	# of Shelves	HP	Amps	Crated Weight lb. (kg.)	Cabinet Dimensions W* D† H (in)	Cabinet Dimensions W* D† H (mm)
BLACK or WHITE EXTERIOR						
THAC-36-HC-LD	3	⅓	5.3	310 (141)	36½ x 30½ x 43¾	918 x 766 x 1102
THAC-48-HC-LD	3	⅓	5.3	365 (166)	48½ x 30½ x 43¾	1223 x 766 x 1102
THAC-60-HC-LD	3	½	7.1	410 (186)	60½ x 30½ x 43¾	1528 x 766 x 1102
STAINLESS STEEL EXTERIOR						
THAC-36-HC-S-LD	3	⅓	5.3	325 (148)	36½ x 30½ x 43¾	918 x 766 x 1102
THAC-48-HC-S-LD	3	⅓	5.3	395 (180)	48½ x 30½ x 43¾	1223 x 766 x 1102
THAC-60-HC-S-LD	3	½	7.1	465 (211)	60½ x 30½ x 43¾	1528 x 766 x 1102
BLACK EXTERIOR "DRY GOODS"						
THAC-36DG-HC-LD	5	¾	5.3	480 (218)	36½ x 30½ x 67¾	918 x 766 x 1705



THAC-36DG-LD "Dry Goods Area" has...

- Stainless steel frame.
- Two 2-tiered wire shelves.
- LED Lighting located on top and each shelf.
- Sliding rear doors.

Recommended Operating Conditions

- Designed to operate in an environment where temperature and humidity do not exceed 75°F (24°C) and 55% relative humidity.
- Units should not be installed near HVAC vents, fans or doorways that will disrupt the air curtain and compromise the function of the cabinet. Units should not be installed in direct sunlight.
- Models will run most efficiently when completely loaded with product.
- Drain plumbing hookup recommended. Factory installed condensate pan heater kit available if there is no access to drain plumbing.
- Please be advised Open Air Merchandisers are substantially louder than standard refrigeration models.

THAC-36DG-HC-LD

Environmentally friendly R290 hydrocarbon refrigeration system for the best in food preservation.





RETAIL MERCHANDISERS



Welcoming a new generation of full sized grocery merchandiser, True's Retail Merchandiser (TRM®) is an advanced self-contained cabinet built for large storage capacity and exceptional display. The TRM® refrigeration system is charged and sealed at the factory using R290 refrigeration, a natural, environmentally friendly future proof refrigerant.

TRM® NOMENCLATURE





RETAIL MERCHANDISER REFRIGERATORS - MEDIUM TEMP

Swing Doors

Take advantage of the install flexibility, convenience, and efficiency of this self-contained case. Fit TRM's through doorways, move the case into location, install the compact sealed condensing systems and plug it in. No refrigeration connections or technicians needed for install



Total of 15 (5 per door) adjustable, solid white powder coated cantilever shelves 30W" x 25D"



The True Dynamic Refrigeration Response System® allows for quick product pull down where and when cooling demand is needed

The entire cabinet structure is built using high-density, polyurethane insulation that has zero ozone depletion potential

NSF/ANSI standard 7 for the storage and/or display of packaged products only

TRM2M-NN-BLK-WHT-1BLKLL-4



TRM3M-NN-BLK-WHT-1BLKLLL-4



TRM4M-NN-BLK-BLK-1BLKLLLL-4



TRM5M-YN-BLK-BLK-1BLKLLLLL-4

Features/Benefits

- Refrigerators maintain holding temperatures of 32°F to 41°F (0°C to 5°C).
- True's Retail Merchandiser (TRM) is an advanced self-contained cabinet built for large storage capacity and exceptional product display.
- Available in 2, 3, and 4 door models, the TRM's are ideal for multi-door case lineups, end cap placements, and general refrigeration storage applications.
- Exterior - non-peel or chip black powder coated cold rolled steel; durable and permanent.
- Interior - attractive, white aluminum interior liner with stainless steel floor. Black aluminum interior available.
- Plug-and-play electrical system for seamless installation (No refrigeration tech or electrician needed).
- 4000k color temperature LED interior lighting, provides brilliant lighting throughout the cabinet.
- Self closing door with stay open feature.
- Magnetic door gasket of one piece construction, removable without tools for ease of cleaning.
- "Low-E", double pane thermal insulated glass door.
- Patented True Level leveling systems for a quick install.
- Self-contained factory charged and sealed refrigerator system.
- Viewable glass height of 70" for maximum product display.
- Exterior Digital Temperature Display.
- Unit completely pre-wired at factory and ready for final connection to a 208-240V-1PH-60Hz, cord and plug set included.

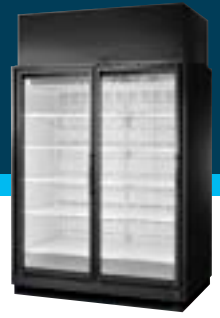

TRM® RETAIL MERCHANDISER REFRIGERATORS

Model	# of Refrigerator Decks*	# of Doors	# of Shelves	HP per Deck	Amps	Crated Weight lb. (kg.)	Cabinet Dimensions W D† H (in)	Cabinet Dimensions W D† H (mm)
SWING DOORS REFRIGERATORS								
TRM2M-NN-BLK-WHT-1BLKLL-4	1	2	10	¾	5.3	1020 (463)	67½ x 38¾ x 102	1715 x 988 x 2591
TRM2M-NY-BLK-WHT-1BLKLL-4	1	2	10	¾	5.3	1020 (463)	67¾ x 38¾ x 102	1711 x 988 x 2591
TRM2M-YN-BLK-WHT-1BLKLL-4	1	2	10	¾	5.3	1020 (463)	66¾ x 38¾ x 102	1685 x 988 x 2591
TRM2M-YY-BLK-WHT-1BLKLL-4	1	2	10	¾	5.3	1020 (463)	66¼ x 38¾ x 102	1681 x 988 x 2591
TRM3M-NN-BLK-WHT-1BLKLLL-4	2	3	15	¾	10.6	1318 (598)	98 x 38¾ x 102	2490 x 988 x 2591
TRM3M-NY-BLK-WHT-1BLKLLL-4	2	3	15	¾	10.6	1318 (598)	97¾ x 38¾ x 102	2486 x 988 x 2591
TRM3M-YN-BLK-WHT-1BLKLLL-4	2	3	15	¾	10.6	1318 (598)	96¾ x 38¾ x 102	2461 x 988 x 2591
TRM3M-YY-BLK-WHT-1BLKLLL-4	2	3	15	¾	10.6	1318 (598)	96¼ x 38¾ x 102	2455 x 988 x 2591
TRM4M-NN-BLK-WHT-1BLKLLLL-4	2	4	20	¾	10.6	1760 (799)	128¾ x 38¾ x 102	3261 x 988 x 2591
TRM4M-NY-BLK-WHT-1BLKLLLL-4	2	4	20	¾	10.6	1760 (799)	128¼ x 38¾ x 102	3258 x 988 x 2591
TRM4M-YN-BLK-WHT-1BLKLLLL-4	2	4	20	¾	10.6	1760 (799)	127¼ x 38¾ x 102	3233 x 988 x 2591
TRM4M-YY-BLK-WHT-1BLKLLLL-4	2	4	20	¾	10.6	1760 (799)	127¼ x 38¾ x 102	3229 x 988 x 2591
TRM5M-NN-BLK-WHT-1BLKLLLLL-4	2	5	25	¾	9.2	2050 (930)	158¾ x 38¾ x 102	4035 X 988 X 2591
TRM5M-NY-BLK-WHT-1BLKLLLLL-4	2	5	25	¾	9.2	2050 (930)	158¼ x 38¾ x 102	4032 x 988 x 2591
TRM5M-YN-BLK-WHT-1BLKLLLLL-4	2	5	25	¾	9.2	2050 (930)	157¾ x 38¾ x 102	4004 x 988 x 2591
TRM5M-YY-BLK-WHT-1BLKLLLLL-4	2	5	25	¾	9.2	2050 (930)	157¼ x 38¾ x 102	4004 x 988 x 2591

† Depth does not include 1½" (39mm) for door handles.

* Refrigeration decks ship separately and individually.

Bankable Units to Create Seamless Look

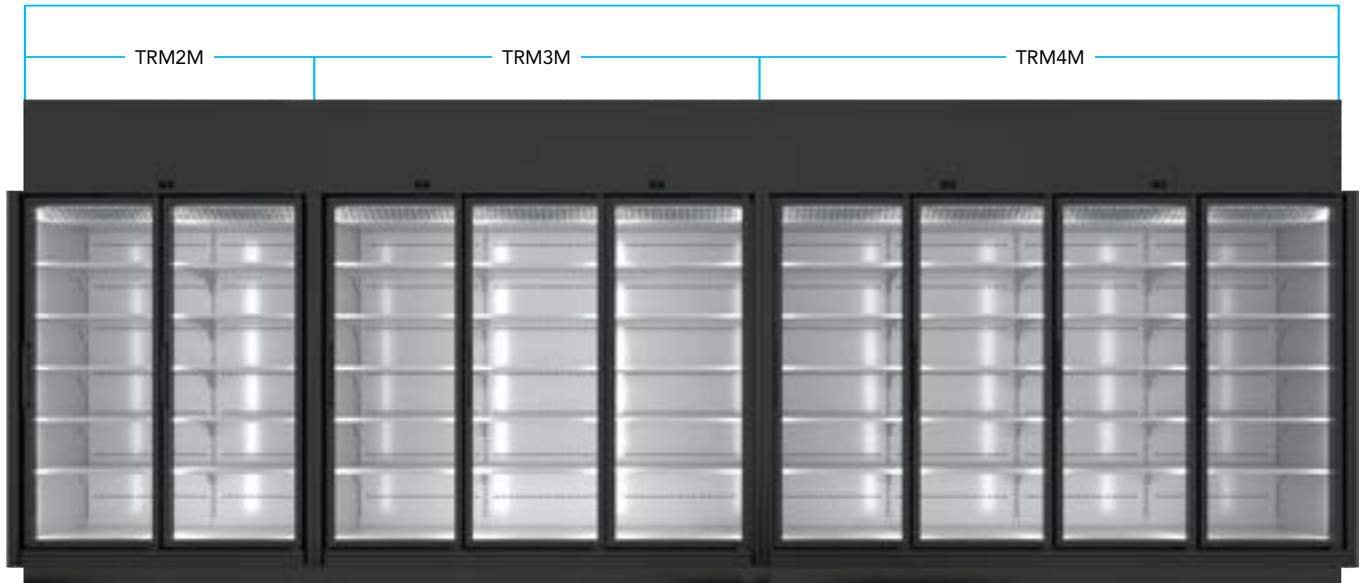

END PANEL CONFIGURATION

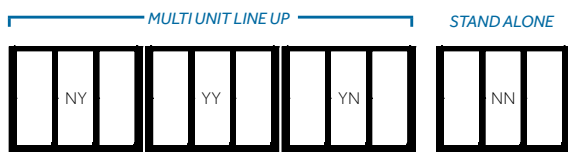

PANELS:

N = 2 ½" (End panel)

Y = 1 ½" (In-line panel)



Environmentally friendly R290 hydrocarbon refrigeration system for the best in food preservation.

RETAIL MERCHANDISER FREEZERS - LOW TEMP

Swing Doors

Take advantage of the install flexibility, convenience, and efficiency of this self-contained case. Fit TRM's through doorways, move the case into location, install the compact sealed condensing systems and plug it in. No refrigeration connections or technicians needed for install



Total of 15 (5 per door) adjustable, solid white powder coated cantilever shelves 30W" x 25D"

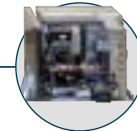

The True Dynamic Refrigeration Response System® allows for quick product pull down where and when cooling demand is needed

The entire cabinet structure is built using high-density, polyurethane insulation that has zero ozone depletion potential

TRM2L-YN-BLK-WHT-1BLKLL-4



TRM3L-NN-BLK-WHT-1BLKLLL-4



TRM4L-NN-BLK-BLK-1BLKLLL-4



TRM5L-YN-BLK-WHT-1BLKLLLLL-4

Features/Benefits

- Freezers maintain holding temperatures of 6°F (-14.4°C) to -10°F (-23.3°C).
- True's Retail Merchandiser (TRM) is an advanced self-contained cabinet built for large storage capacity and exceptional product display.
- Available in 2, 3, and 4 door models, the TRM's are ideal for multi-door case lineups, end cap placements, and general refrigeration storage applications.
- Exterior - non-peel or chip black powder coated cold rolled steel; durable and permanent.
- Interior - attractive, white aluminum interior liner with stainless steel floor. Black aluminum interior available.
- Plug-and-play electrical system for seamless installation (No refrigeration tech or electrician needed).
- 4000k color temperature LED interior lighting, provides brilliant lighting throughout the cabinet.
- Self closing door with stay open feature.
- Magnetic door gasket of one piece construction, removable without tools for ease of cleaning.
- "Low-E", triple pane thermal insulated glass door.
- Patented True Level leveling systems for a quick install.
- Self-contained factory charged and sealed refrigerator system.
- Viewable glass height of 70" for maximum product display.
- Exterior Digital Temperature Display.
- Unit completely pre-wired at factory and ready for final connection to a 208-240V-1PH-60Hz, cord and plug set included.



TRM® RETAIL MERCHANDISER FREEZERS

Model	# of Refrigerator Decks*	# of Doors	# of Shelves	HP per Deck	Amps	Crated Weight lb. (kg.)	Cabinet Dimensions W D† H (in)	Cabinet Dimensions W D† H (mm)
SWING DOORS REFRIGERATORS								
TRM2L-NN-BLK-WHT-1BLKLL-4	2	2	10	1¼	13.8	1020 (463)	67½ x 38⅞ x 102	1715 x 988 x 2591
TRM2L-NY-BLK-WHT-1BLKLL-4	2	2	10	1¼	13.8	1020 (463)	67⅞ x 38⅞ x 102	1712 x 988 x 2591
TRM2L-YN-BLK-WHT-1BLKLL-4	2	2	10	1¼	13.8	1020 (463)	66⅜ x 38⅞ x 102	1686 x 988 x 2591
TRM2L-YY-BLK-WHT-1BLKLL-4	2	2	10	1¼	13.8	1020 (463)	66¼ x 38⅞ x 102	1683 x 988 x 2591
TRM3L-NN-BLK-WHT-1BLKLLL-4	2	3	15	1¼	13.8	1318 (598)	98 x 38⅞ x 102	2490 x 988 x 2591
TRM3L-NY-BLK-WHT-1BLKLLL-4	2	3	15	1¼	13.8	1318 (598)	97⅞ x 38⅞ x 102	2486 x 988 x 2591
TRM3L-YN-BLK-WHT-1BLKLLL-4	2	3	15	1¼	13.8	1318 (598)	96⅞ x 38⅞ x 102	2461 x 988 x 2591
TRM3L-YY-BLK-WHT-1BLKLLL-4	2	3	15	1¼	13.8	1318 (598)	96⅝ x 38⅞ x 102	2455 x 988 x 2591
TRM4L-NN-BLK-WHT-1BLKLLLL-4	3	4	20	1¼	19.6	1760 (799)	128⅜ x 38⅞ x 102	3261 x 988 x 2591
TRM4L-NY-BLK-WHT-1BLKLLLL-4	3	4	20	1¼	19.6	1760 (799)	128¼ x 38⅞ x 102	3258 x 988 x 2591
TRM4L-YN-BLK-WHT-1BLKLLLL-4	3	4	20	1¼	19.6	1760 (799)	127¼ x 38⅞ x 102	3233 x 988 x 2591
TRM4L-YY-BLK-WHT-1BLKLLLL-4	3	4	20	1¼	19.6	1760 (799)	127⅝ x 38⅞ x 102	3229 x 988 x 2591
TRM5L-NN-BLK-WHT-1BLKLLLLL-4	3	5	25	1¼	18.3	2050 (930)	158¾ x 38⅞ x 102	4032 x 988 x 2591
TRM5L-NY-BLK-WHT-1BLKLLLLL-4	3	5	25	1¼	18.3	2050 (930)	158¾ x 38⅞ x 102	4032 x 988 x 2591
TRM5L-YN-BLK-WHT-1BLKLLLLL-4	3	5	25	1¼	18.3	2050 (930)	157⅞ x 38⅞ x 102	4004 x 988 x 2591
TRM5L-YY-BLK-WHT-1BLKLLLLL-4	3	5	25	1¼	18.3	2050 (930)	157⅝ x 38⅞ x 102	4004 x 988 x 2591

† Depth does not include 1½" (39mm) for door handles.
 * Refrigeration decks ship separately and individually.

Bankable Units to Create Seamless Look

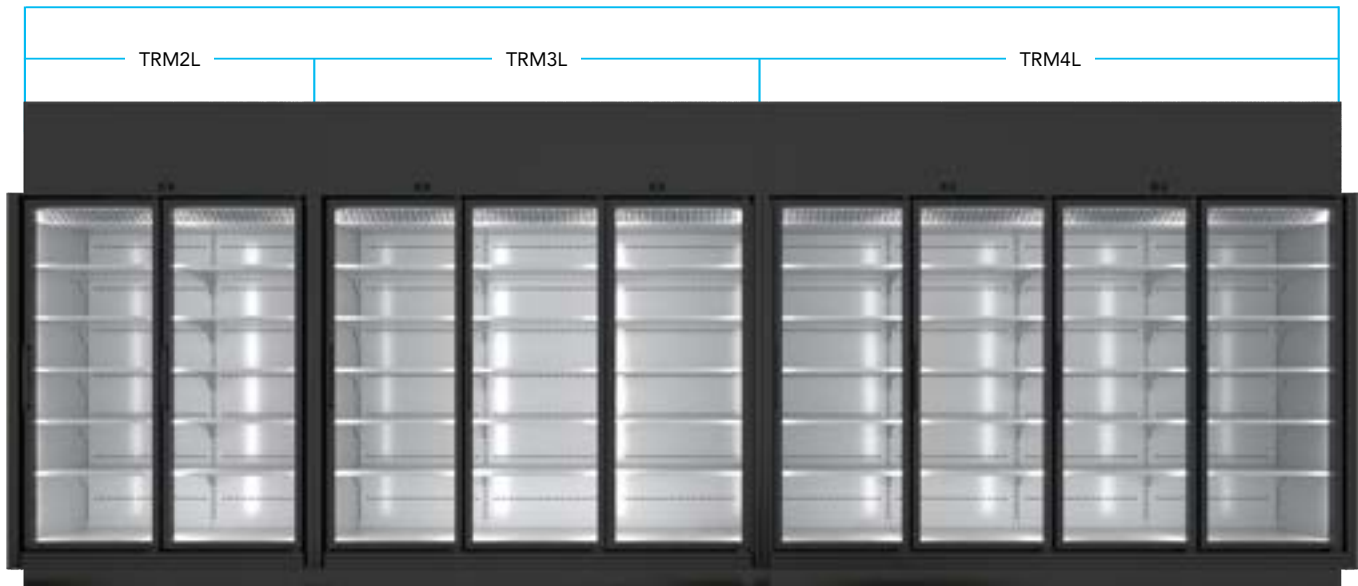

END PANEL CONFIGURATION

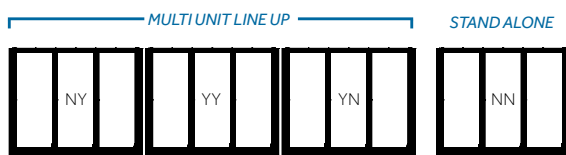

PANELS:
 N = 2 ½" (End panel)
 Y = 1 ½" (In-line panel)

Environmentally friendly R290 hydrocarbon refrigeration system for the best in food preservation.



RETAIL MERCHANDISER - ICE STORAGE

Swing Doors

Take advantage of the install flexibility, convenience, and efficiency of this self-contained case. Fit TRM's through doorways, move the case into location, install the compact sealed condensing systems and plug it in. No refrigeration connections or technicians needed for install



Holds (220) 8lbs. (4kg) bags of ice.

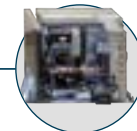

The True Dynamic Refrigeration Response System® allows for quick product pull down where and when cooling demand is needed

The entire cabinet structure is built using high-density, polyurethane insulation that has zero ozone depletion potential

TRM2I-NN-BLK-WHT-1BLKLL-4

Features/Benefits

- Freezers maintain holding temperatures of 12°F (-11.1°C) to 18°F (-7.8°C).
- True's Retail Merchandiser (TRM) is an advanced self-contained cabinet built for large storage capacity and exceptional product display.
- TRM's are ideal for multi-door case lineups, end cap placements, and general refrigeration storage applications.
- Exterior - non-peel or chip black powder coated cold rolled steel; durable and permanent.
- Interior - attractive, white aluminum interior liner with stainless steel floor. Black aluminum interior available.
- Plug-and-play electrical system for seamless installation (No refrigeration tech or electrician needed).
- 4000k color temperature LED interior lighting, provides brilliant lighting throughout the cabinet.
- Self closing door with stay open feature.
- Magnetic door gasket of one piece construction, removable without tools for ease of cleaning.
- "Low-E", triple pane thermal insulated glass door.
- Patented True Level leveling systems for a quick install.
- Self-contained factory charged and sealed refrigerator system.
- Viewable glass height of 70" for maximum product display.
- Exterior Digital Temperature Display.
- Unit completely pre-wired at factory and ready for final connection to a 208-240V-1PH-60Hz, cord and plug set included.

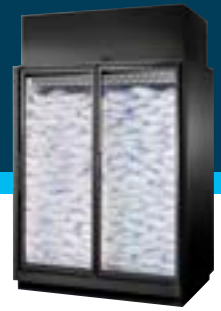

TRM[®] RETAIL MERCHANDISER - ICE STORAGE

Model	# of Refrigerator Decks*	# of Doors	# of Shelves	HP per Deck	Amps	Crated Weight lb. (kg.)	Cabinet Dimensions W D† H (in)	Cabinet Dimensions W D† H (mm)
SWING DOORS REFRIGERATORS								
TRM2I-NN-BLK-WHT-1BLKLL-4	1	2	0	1¼	6.9	1000 (454)	67½ x 38¾ x 102	1715 x 988 x 2591
TRM2I-NY-BLK-WHT-1BLKLL-4	1	2	0	1¼	6.9	1000 (454)	67¾ x 38¾ x 102	1712 x 988 x 2591
TRM2I-YN-BLK-WHT-1BLKLL-4	1	2	0	1¼	6.9	1000 (454)	66¾ x 38¾ x 102	1686 x 988 x 2591
TRM2I-YY-BLK-WHT-1BLKLL-4	1	2	0	1¼	6.9	1000 (454)	66¼ x 38¾ x 102	1683 x 988 x 2591

† Depth does not include 1½" (39mm) for door handles.

* Refrigeration decks ship separately and individually.

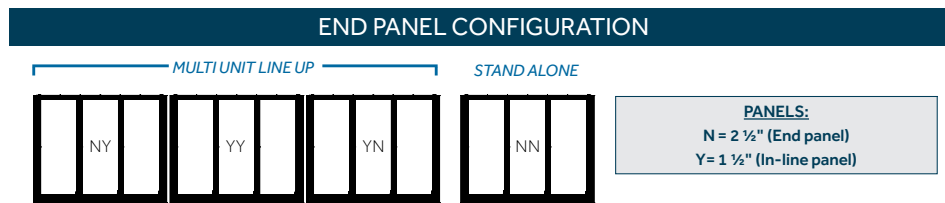

Environmentally friendly R290 hydrocarbon refrigeration system for the best in food preservation.





CURVED GLASS DISPLAY MERCHANDISERS



The innovative curved glass display merchandiser design marries the sophistication of a curved glass display with enhanced performance. The TDM™ Series display merchandisers are ideally suited for high-end interiors that demand premium materials and technical innovation.

TDM™ & TGM™ NOMENCLATURE

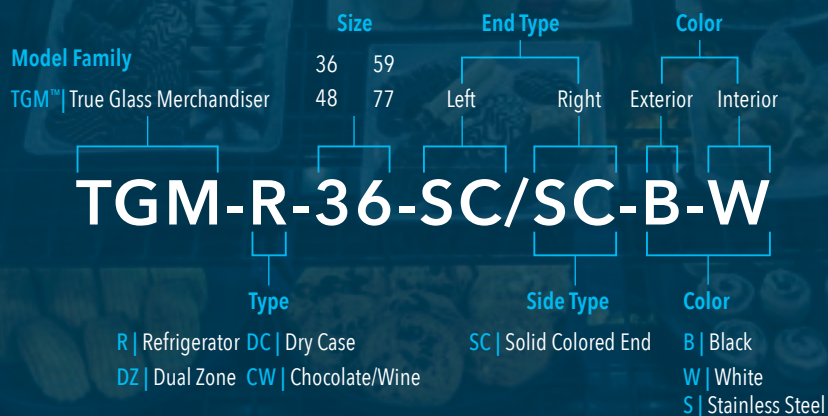
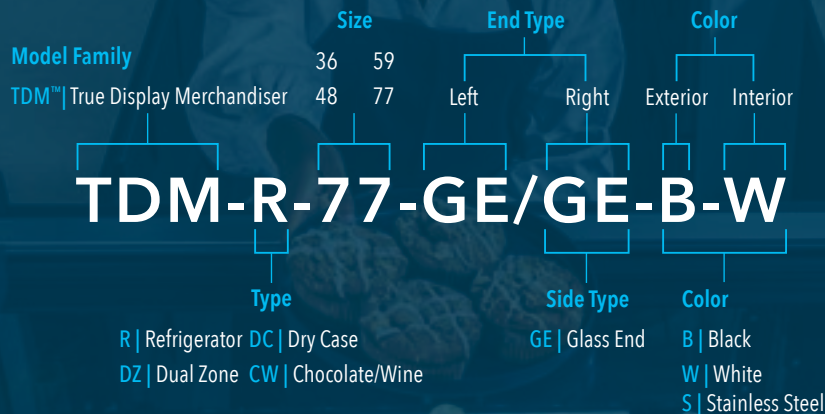



Curved Glass Display Merchandisers | TDM™-R

FRONT-ACCESS REFRIGERATED DISPLAY MERCHANDISERS

Glass & Mirrored Ends

Three (3) tiered levels of adjustable wire cantilever shelves that match cabinet interior color. Chrome plated wire shelves standard on stainless interior units



Front glass swings up for easy cleaning access



Two (2) rear sliding glass doors for back access

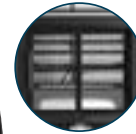

Exclusive reversing condenser fan motor. Fan motor reverses during defrost off cycles to help keep condenser coil free from dirt, dust and debris. Keeping coils clean optimizes the unit's performance providing colder holding temperatures and increased energy efficiency. Regularly scheduled thorough cleaning of coils still recommended

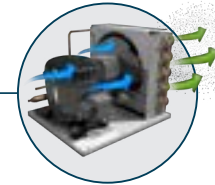

TDM-R-36-GE/GE-B-W



TDM-R-36-GE/GE-S-W



TDM-R-48-GE/GE-W-W



TDM-R-59-GE/GE-B-W



TDM-R-77-GE/GE-B-W

Features/Benefits

- Refrigeration system that has two (2) temperature range options. Standard temperature range maintains cabinet temperatures of 33°F to 41°F (.5°C to 5°C), ideally suited for refrigerated bakery and cold deli products. Optional temperature range maintains cabinet temperatures of 42°F to 65°F (5.5°C to 18.3°C), ideally suited for chocolate & wine options.
- True's refrigerated display case combines efficient, high volume merchandising and exceptional refrigeration with an elegant curved glass front for sophisticated presentation of high-end deli, desserts and pastries.
- NSF/ANSI Standard 7 compliant for open food product. Tested and certified for performance at NSF Type II: 80°F (27°C) and 55% relative humidity.
- Exterior - powder coated FDA black rounded front and back, black aluminum aesthetic side and front panels. Color options available at no charge - white or stainless. Curved glass front and side glass panels.
- Interior - powder coated FDA white over CRS material. Color options available (upcharge applies) - black or stainless.
- LED interior lighting provides more even lighting throughout the cabinet. Safety shielded.
- Standard in Clear Glass Ends (GE).
- TDM's have a variety of optional interior/exterior shelving available (see accessory section for details).
- Designed to provide an attractive companion to our TDM-DC "dry case" display merchandiser.



TDM™-R FRONT-ACCESS REFRIGERATED DISPLAY MERCHANDISERS

Model	# of Doors	# of Shelves	HP	Amps	Crated Weight lb. (kg.)	Cabinet Dimensions W D† H* (in)	Cabinet Dimensions W D† H* (mm)
GLASS END/GLASS END WITH BLACK EXTERIOR/WHITE INTERIOR							
TDM-R-36-GE/GE-B-W	2	3	¼	10.0	540 (245)	36¼ x 39 x 49½	921 x 991 x 1248
TDM-R-48-GE/GE-B-W	2	3	½	12.0	645 (293)	48¼ x 39 x 49½	1226 x 991 x 1248
TDM-R-59-GE/GE-B-W	2	3	½	12.0	760 (345)	59¼ x 39 x 49½	1505 x 991 x 1248
TDM-R-77-GE/GE-B-W	2	3	½	12.0	845 (384)	77¼ x 39 x 49½	1963 x 991 x 1248
GLASS END/GLASS END WITH WHITE EXTERIOR/WHITE INTERIOR							
TDM-R-36-GE/GE-W-W	2	3	¼	10.0	540 (245)	36¼ x 39 x 49½	921 x 991 x 1248
TDM-R-48-GE/GE-W-W	2	3	½	12.0	645 (293)	48¼ x 39 x 49½	1226 x 991 x 1248
TDM-R-59-GE/GE-W-W	2	3	½	12.0	760 (345)	59¼ x 39 x 49½	1505 x 991 x 1248
TDM-R-77-GE/GE-W-W	2	3	½	12.0	845 (384)	77¼ x 39 x 49½	1963 x 991 x 1248
GLASS END/GLASS END WITH STAINLESS EXTERIOR/WHITE INTERIOR							
TDM-R-36-GE/GE-S-W	2	3	¼	10.0	660 (300)	36¼ x 39 x 49½	921 x 991 x 1248
TDM-R-48-GE/GE-S-W	2	3	½	12.0	645 (293)	48¼ x 39 x 49½	1226 x 991 x 1248
TDM-R-59-GE/GE-S-W	2	3	½	12.0	760 (345)	59¼ x 39 x 49½	1505 x 991 x 1248
TDM-R-77-GE/GE-S-W	2	3	½	12.0	850 (386)	77¼ x 39 x 49½	1963 x 991 x 1248
GLASS END/GLASS END WITH STAINLESS EXTERIOR/STAINLESS INTERIOR							
TDM-R-36-GE/GE-S-S	2	3	¼	10.0	660 (300)	36¼ x 39 x 49½	921 x 991 x 1248
TDM-R-48-GE/GE-S-S	2	3	½	12.0	645 (293)	48¼ x 39 x 49½	1226 x 991 x 1248
TDM-R-59-GE/GE-S-S	2	3	½	12.0	760 (345)	59¼ x 39 x 49½	1505 x 991 x 1248
TDM-R-77-GE/GE-S-S	2	3	½	12.0	850 (386)	77¼ x 39 x 49½	1963 x 991 x 1248

EXTERIORS (Custom color available upon request)

GE



Clear Glass Interior / Clear Glass Exterior with Black Trim

Environmentally friendly R290 hydrocarbon refrigeration system for the best in food preservation.



Curved Glass Display Merchandisers | TDM™-DZ

FRONT-ACCESS DUAL ZONE DISPLAY MERCHANDISERS

Glass & Mirrored Ends

Three (3) tiered levels of adjustable wire cantilever shelves that match cabinet interior color. Chrome plated wire shelves standard on stainless interior units



Front glass swings up for easy cleaning access



Two (2) rear sliding glass doors for back access

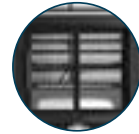

Exclusive reversing condenser fan motor. Fan motor reverses during defrost off cycles to help keep condenser coil free from dirt, dust and debris. Keeping coils clean optimizes the unit's performance providing colder holding temperatures and increased energy efficiency. Regularly scheduled thorough cleaning of coils still recommended

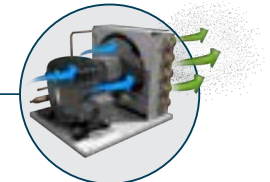

TDM-DZ-59-GE/GE-B-W



TDM-DZ-48-GE/GE-S-W



TDM-DZ-59-GE/GE-S-S



TDM-DZ-77-GE/GE-B-W

Features/Benefits

- Refrigeration system that has two (2) temperature range options. Standard temperature range maintains cabinet temperatures of 33°F to 41°F (5°C to 5°C), ideally suited for refrigerated bakery and cold deli products. Optional temperature range maintains cabinet temperatures of 42°F to 65°F (5.5°C to 18.3°C), ideally suited for chocolate & wine options.
- True's combination "refrigerated" and "dry" display case combines efficient, high volume merchandising and exceptional refrigeration with an elegant curved glass front for sophisticated presentation of high-end deli, desserts and pastries.
- NSF/ANSI Standard 7 compliant for open food product. Tested and certified for performance at NSF Type II: 80°F (27°C) and 55% relative humidity.
- Exterior - powder coated FDA black rounded front and back, black aluminum aesthetic side and front panels. Color options available at no charge - white or stainless. Curved glass front and side glass panels.
- Interior - powder coated FDA white over CRS material. Color options available (upcharge applies) - black or stainless.
- LED interior lighting provides more even lighting throughout the cabinet. Safety shielded.
- Standard in Clear Glass Ends (GE).
- TDM's have a variety of optional interior/exterior shelving available (see accessory section for details).
- Designed to provide an attractive companion to our TDM-R "refrigerated" or TDM-DC "dry case" display merchandiser.



TDM™-DZ FRONT-ACCESS DUAL ZONE DISPLAY MERCHANDISERS

Model	# of Doors	# of Shelves	HP	Amps	Crated Weight lb. (kg.)	Cabinet Dimensions W D† H* (in)	Cabinet Dimensions W D† H* (mm)
GLASS END/GLASS END WITH BLACK EXTERIOR/WHITE INTERIOR							
TDM-DZ-48-GE/GE-B-W	2	6	¼	10.0	690 (313)	48¼ x 39 x 49½	1226 x 991 x 1248
TDM-DZ-59-GE/GE-B-W	2	6	¼	10.0	770 (350)	59¼ x 39 x 49½	1505 x 991 x 1248
TDM-DZ-77-GE/GE-B-W	2	6	¼	10.0	795 (361)	77¼ x 39 x 49½	1963 x 991 x 1248
GLASS END/GLASS END WITH WHITE EXTERIOR/WHITE INTERIOR							
TDM-DZ-48-GE/GE-W-W	2	6	¼	10.0	690 (313)	48¼ x 39 x 49½	1226 x 991 x 1248
TDM-DZ-59-GE/GE-W-W	2	6	¼	10.0	770 (350)	59¼ x 39 x 49½	1505 x 991 x 1248
TDM-DZ-77-GE/GE-W-W	2	6	¼	10.0	920 (418)	77¼ x 39 x 49½	1963 x 991 x 1248
GLASS END/GLASS END WITH STAINLESS EXTERIOR/WHITE INTERIOR							
TDM-DZ-48-GE/GE-S-W	2	6	¼	10.0	665 (302)	48¼ x 39 x 49½	1226 x 991 x 1248
TDM-DZ-59-GE/GE-S-W	2	6	¼	10.0	680 (309)	59¼ x 39 x 49½	1505 x 991 x 1248
TDM-DZ-77-GE/GE-S-W	2	6	¼	10.0	920 (418)	77¼ x 39 x 49½	1963 x 991 x 1248
GLASS END/GLASS END WITH STAINLESS EXTERIOR/STAINLESS INTERIOR							
TDM-DZ-48-GE/GE-S-S	2	6	¼	10.0	665 (302)	48¼ x 39 x 49½	1226 x 991 x 1248
TDM-DZ-59-GE/GE-S-S	2	6	¼	10.0	680 (309)	59¼ x 39 x 49½	1505 x 991 x 1248
TDM-DZ-77-GE/GE-S-S	2	6	¼	10.0	920 (418)	77¼ x 39 x 49½	1963 x 991 x 1248

EXTERIORS (Custom color available upon request)

GE



Clear Glass Interior / Clear Glass Exterior with Black Trim

Environmentally friendly R290 hydrocarbon refrigeration system for the best in food preservation.



FRONT-ACCESS DRY DISPLAY MERCHANDISERS

Glass & Mirrored Ends

Three (3) tiered levels of adjustable wire cantilever shelves that match cabinet interior color. Chrome plated wire shelves standard on stainless interior units



Front glass swings up for easy cleaning access



Two (2) rear sliding glass doors for back access

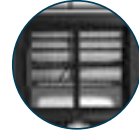

TDM-DC-48-GE/GE-B-W



TDM-DC-36-GE/GE-B-W



TDM-DC-48-GE/GE-S-S



TDM-DC-59-GE/GE-B-W



TDM-DC-77-GE/GE-W-W

Features/Benefits

- True's "dry" display case combines efficient, high volume merchandising with an elegant curved glass front for sophisticated presentation of high-end desserts and pastries.
- Cabinet is NSF/ANSI Standard 2 certified to hold open food product.
- Exterior - powder coated FDA black rounded front and back, black aluminum aesthetic side and front panels. Color options available at no charge - white or stainless. Curved glass front and side glass panels.
- Interior - powder coated FDA white over CRS material. Color options available (upcharge applies) - black or stainless.
- LED interior lighting provides more even lighting throughout the cabinet. Safety shielded.
- Standard in Clear Glass Ends (GE).
- TDM's have a variety of optional interior/exterior shelving available (see accessory section for details).
- Designed to provide an attractive companion to our TDM-R "refrigerated" display merchandiser. TDM-DC "dry case" cabinets do not require refrigeration



TDM™-DC FRONT-ACCESS DRY DISPLAY MERCHANDISERS

Model	# of Doors	# of Shelves	Amps	Crated Weight lb. (kg.)	Cabinet Dimensions W D† H* (in)	Cabinet Dimensions W D† H* (mm)
GLASS END/GLASS END WITH BLACK EXTERIOR/WHITE INTERIOR						
TDM-DC-36-GE/GE-B-W	2	3	7.0	485 (220)	36¼ x 39 x 49½	921 x 991 x 1248
TDM-DC-48-GE/GE-B-W	2	3	7.0	580 (264)	48¼ x 39 x 49½	1226 x 991 x 1248
TDM-DC-59-GE/GE-B-W	2	3	7.0	665 (302)	59¼ x 39 x 49½	1505 x 991 x 1248
TDM-DC-77-GE/GE-B-W	2	3	7.0	685 (311)	77¼ x 39 x 49½	1963 x 991 x 1248
GLASS END/GLASS END WITH WHITE EXTERIOR/WHITE INTERIOR						
TDM-DC-36-GE/GE-W-W	2	3	7.0	485 (220)	36¼ x 39 x 49½	921 x 991 x 1248
TDM-DC-48-GE/GE-W-W	2	3	7.0	580 (264)	48¼ x 39 x 49½	1226 x 991 x 1248
TDM-DC-59-GE/GE-W-W	2	3	7.0	665 (302)	59¼ x 39 x 49½	1505 x 991 x 1248
TDM-DC-77-GE/GE-W-W	2	3	7.0	685 (311)	77¼ x 39 x 49½	1963 x 991 x 1248
GLASS END/GLASS END WITH STAINLESS EXTERIOR/WHITE INTERIOR						
TDM-DC-36-GE/GE-S-W	2	3	7.0	490 (223)	36¼ x 39 x 49½	921 x 991 x 1248
TDM-DC-48-GE/GE-S-W	2	3	7.0	580 (264)	48¼ x 39 x 49½	1226 x 991 x 1248
TDM-DC-59-GE/GE-S-W	2	3	7.0	665 (302)	59¼ x 39 x 49½	1505 x 991 x 1248
TDM-DC-77-GE/GE-S-W	2	3	7.0	830 (377)	77¼ x 39 x 49½	1963 x 991 x 1248
GLASS END/GLASS END WITH STAINLESS EXTERIOR/STAINLESS INTERIOR						
TDM-DC-36-GE/GE-S-S	2	3	7.0	485 (220)	36¼ x 39 x 49½	921 x 991 x 1248
TDM-DC-48-GE/GE-S-S	2	3	7.0	580 (264)	48¼ x 39 x 49½	1226 x 991 x 1248
TDM-DC-59-GE/GE-S-S	2	3	7.0	665 (302)	59¼ x 39 x 49½	1505 x 991 x 1248
TDM-DC-77-GE/GE-S-S	2	3	7.0	830 (377)	77¼ x 39 x 49½	1963 x 991 x 1248

EXTERIORS (Custom color available upon request)

GE



Clear Glass Interior / Clear Glass Exterior with Black Trim

FIXED GLASS REFRIGERATED MERCHANDISERS

Solid Colored & Mirrored Ends

Two (2) rear sliding glass doors for back access



Curved glass front and side glass panels



Three (3) tiered levels of adjustable wire cantilever shelves that match cabinet interior color. Chrome plated wire shelves standard on stainless interior units



Exclusive reversing condenser fan motor. Fan motor reverses during defrost off cycles to help keep condenser coil free from dirt, dust and debris. Keeping coils clean optimizes the unit's performance providing colder holding temperatures and increased energy efficiency. Regularly scheduled thorough cleaning of coils still recommended

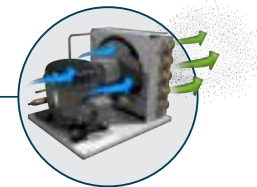

TGM-R-34-SC/SC-B-S



TGM-R-36-SC/SC-W-W



TGM-R-59-SC/SC-S-W



TGM-R-77-SC/SC-B-W

Features/Benefits

- Refrigeration system that has two (2) temperature range options. Standard temperature range maintains cabinet temperatures of 33°F to 41°F (.5°C to 5°C), ideally suited for refrigerated bakery and cold deli products. Optional temperature range maintains cabinet temperatures of 42°F to 65°F (5.5°C to 18.3°C), ideally suited for chocolate & wine options.
- True's refrigerated display case combines efficient, high volume merchandising and exceptional refrigeration with an elegant curved glass front for sophisticated presentation of high-end deli, desserts and pastries.
- NSF/ANSI Standard 7 compliant for open food product. Tested and certified for performance at NSF Type II: 80°F (27°C) and 55% relative humidity.
- Exterior - powder coated FDA black rounded front and back, solid wood sides with aluminum cover and front panels. Color options available (upcharge may apply) - white or stainless.
- Interior - powder coated FDA white over CRS material. Color options available (upcharge applies) - black or stainless.
- LED interior lighting provides more even lighting throughout the cabinet. Safety shielded.
- Standard in Solid Colored Ends (SC).
- TGM's have a variety of optional interior/exterior shelving available (see accessory section for details).
- Designed to provide an attractive companion to our TDM-DC "dry case" display merchandiser.



TGM™-R FIXED GLASS REFRIGERATED MERCHANDISERS

Model	# of Doors	# of Shelves	HP	Amps	Crated Weight lb. (kg.)	Cabinet Dimensions W D† H* (in)	Cabinet Dimensions W D† H* (mm)
SOLID COLORED END/SOLID COLORED END WITH BLACK EXTERIOR/WHITE INTERIOR							
TGM-R-36-SC/SC-B-W	2	6	¼	10.0	580 (264)	36¼ x 39 x 49½	921 x 991 x 1248
TGM-R-48-SC/SC-B-W	2	6	½	12.0	685 (311)	48¼ x 39 x 49½	1226 x 991 x 1248
TGM-R-59-SC/SC-B-W	2	6	½	12.0	760 (345)	59¼ x 39 x 49½	1505 x 991 x 1248
TGM-R-77-SC/SC-B-W	2	6	½	12.0	935 (425)	77¼ x 39 x 49½	1963 x 991 x 1248
SOLID COLORED END/SOLID COLORED END WITH WHITE EXTERIOR/WHITE INTERIOR							
TGM-R-36-SC/SC-W-W	2	6	¼	10.0	580 (264)	36¼ x 39 x 49½	921 x 991 x 1248
TGM-R-48-SC/SC-W-W	2	6	½	12.0	685 (311)	48¼ x 39 x 49½	1226 x 991 x 1248
TGM-R-59-SC/SC-W-W	2	6	½	12.0	760 (345)	59¼ x 39 x 49½	1505 x 991 x 1248
TGM-R-77-SC/SC-W-W	2	6	½	12.0	935 (425)	77¼ x 39 x 49½	1963 x 991 x 1248
SOLID COLORED END/SOLID COLORED END WITH STAINLESS EXTERIOR/WHITE INTERIOR							
TGM-R-36-SC/SC-S-W	2	6	¼	10.0	580 (264)	36¼ x 39 x 49½	921 x 991 x 1248
TGM-R-48-SC/SC-S-W	2	6	½	12.0	685 (311)	48¼ x 39 x 49½	1226 x 991 x 1248
TGM-R-59-SC/SC-S-W	2	6	½	12.0	760 (345)	59¼ x 39 x 49½	1505 x 991 x 1248
TGM-R-77-SC/SC-S-W	2	6	½	12.0	855 (388)	77¼ x 39 x 49½	1963 x 991 x 1248
SOLID COLORED END/SOLID COLORED END WITH STAINLESS EXTERIOR/STAINLESS INTERIOR							
TGM-R-36-SC/SC-S-S	2	6	¼	10.0	580 (264)	36¼ x 39 x 49½	921 x 991 x 1248
TGM-R-48-SC/SC-S-S	2	6	½	12.0	685 (311)	48¼ x 39 x 49½	1226 x 991 x 1248
TGM-R-59-SC/SC-S-S	2	6	½	12.0	760 (345)	59¼ x 39 x 49½	1505 x 991 x 1248
TGM-R-77-SC/SC-S-S	2	6	½	12.0	855 (388)	77¼ x 39 x 49½	1963 x 991 x 1248

Environmentally friendly R290 hydrocarbon refrigeration system for the best in food preservation.



FIXED GLASS DUAL ZONE MERCHANDISERS

Solid Colored & Mirrored Ends

Two (2) rear sliding glass doors for back access



Three (3) tiered levels of adjustable wire cantilever shelves that match cabinet interior color. Chrome plated wire shelves standard on stainless interior units



Curved glass front and side glass panels

Exclusive reversing condenser fan motor. Fan motor reverses during defrost off cycles to help keep condenser coil free from dirt, dust and debris. Keeping coils clean optimizes the unit's performance providing colder holding temperatures and increased energy efficiency. Regularly scheduled thorough cleaning of coils still recommended

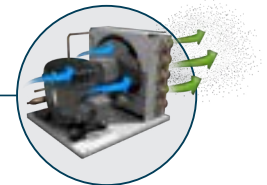

TGM-DZ-59-SC/SC-B-W



TGM-DZ-48-SC/SC-S-W



TGM-DZ-59-SC/SC-W-W



TGM-DZ-77-SC/SC-B-W

Features/Benefits

- Refrigeration system that has two (2) temperature range options. Standard temperature range maintains cabinet temperatures of 33°F to 41°F (.5°C to 5°C), ideally suited for refrigerated bakery and cold deli products. Optional temperature range maintains cabinet temperatures of 42°F to 65°F (5.5°C to 18.3°C), ideally suited for chocolate & wine options.
- True's combination "refrigerated" and "dry" glass merchandiser combines efficient, high volume merchandising and exceptional refrigeration with an elegant curved glass front for sophisticated presentation of high-end deli, desserts and pastries.
- NSF/ANSI Standard 7 compliant for open food product. Tested and certified for performance at NSF Type II: 80°F (27°C) and 55% relative humidity.
- Exterior - powder coated FDA black rounded front and back, solid wood sides with aluminum cover and front panels. Color options available (upcharge may apply) - white or stainless.
- Interior - powder coated FDA white over CRS material. Color options available (upcharge applies) - black or stainless.
- LED interior lighting provides more even lighting throughout the cabinet. Safety shielded.
- Standard in Solid Colored Ends (SC).
- TGM's have a variety of optional interior/exterior shelving available (see accessory section for details).
- Designed to provide an attractive companion to our TGM-R "refrigerated" or TGM-DC "dry case" display merchandiser.



TGM™-DZ FIXED GLASS DUAL ZONE MERCHANDISERS

Model	# of Doors	# of Shelves	HP	Amps	Crated Weight lb. (kg.)	Cabinet Dimensions W D† H* (in)	Cabinet Dimensions W D† H* (mm)
SOLID COLORED END/SOLID COLORED END WITH BLACK EXTERIOR/WHITE INTERIOR							
TGM-DZ-48-SC/SC-B-W	2	6	¼	10.0	710 (323)	48¼ x 39 x 49½	1226 x 991 x 1248
TGM-DZ-59-SC/SC-B-W	2	6	¼	10.0	800 (363)	59¼ x 39 x 49½	1505 x 991 x 1248
TGM-DZ-77-SC/SC-B-W	2	6	¼	10.0	940 (427)	77¼ x 39 x 49½	1962 x 991 x 1248
SOLID COLORED END/SOLID COLORED END WITH WHITE EXTERIOR/WHITE INTERIOR							
TGM-DZ-48-SC/SC-W-W	2	6	¼	10.0	665 (302)	48¼ x 39 x 49½	1226 x 991 x 1248
TGM-DZ-59-SC/SC-W-W	2	6	¼	10.0	800 (363)	59¼ x 39 x 49½	1505 x 991 x 1248
TGM-DZ-77-SC/SC-W-W	2	6	¼	10.0	940 (427)	77¼ x 39 x 49½	1962 x 991 x 1248
SOLID COLORED END/SOLID COLORED END WITH STAINLESS EXTERIOR/WHITE INTERIOR							
TGM-DZ-48-SC/SC-S-W	2	6	¼	10.0	710 (323)	48¼ x 39 x 49½	1226 x 991 x 1248
TGM-DZ-59-SC/SC-S-W	2	6	¼	10.0	770 (350)	59¼ x 39 x 49½	1505 x 991 x 1248
TGM-DZ-77-SC/SC-S-W	2	6	¼	10.0	940 (427)	77¼ x 39 x 49½	1962 x 991 x 1248
SOLID COLORED END/SOLID COLORED END WITH STAINLESS EXTERIOR/STAINLESS INTERIOR							
TGM-DZ-48-SC/SC-S-S	2	6	¼	10.0	665 (302)	48¼ x 39 x 49½	1226 x 991 x 1248
TGM-DZ-59-SC/SC-S-S	2	6	¼	10.0	800 (363)	59¼ x 39 x 49½	1505 x 991 x 1248
TGM-DZ-77-SC/SC-S-S	2	6	¼	10.0	940 (427)	77¼ x 39 x 49½	1962 x 991 x 1248

Environmentally friendly R290 hydrocarbon refrigeration system for the best in food preservation.



FIXED GLASS DRY MERCHANDISERS

Sold Colored & Mirrored Ends

Two (2) rear sliding glass doors for back access



Curved glass front and side glass panels



Three (3) tiered levels of adjustable wire cantilever shelves that match cabinet interior color. Chrome plated wire shelves standard on stainless interior units



TGM-DC-48-SC/SC-B-W



TGM-DC-36-SC/SC-B-W



TGM-DC-48-SC/SC-W-W



TGM-DC-59-SC/SC-S-S



TDM-DC-77-SC/SC-S-W

Features/Benefits

- True's "dry" display case combines efficient, high volume merchandising with an elegant curved glass front for sophisticated presentation of high-end desserts and pastries.
- Cabinet is NSF/ANSI Standard 2 certified to hold open food product.
- Exterior - powder coated FDA black rounded front and back, solid wood sides with aluminum cover and front panels. Color options available (upcharge may apply) - white or stainless.
- Interior - powder coated FDA white over CRS material. Color options available (upcharge applies) - black or stainless.
- LED interior lighting provides more even lighting throughout the cabinet. Safety shielded.
- Standard in Solid Colored Ends (SC).
- TDM's have a variety of optional interior/exterior shelving available (see accessory section for details).
- Designed to provide an attractive companion to our TGM-R "refrigerated" display merchandiser. TGM-DC "dry case" cabinets do not require refrigeration



TGM™-DC FIXED GLASS DRY MERCHANDISERS

Model	# of Doors	# of Shelves	Amps	Crated Weight lb. (kg.)	Cabinet Dimensions W D† H* (in)	Cabinet Dimensions W D† H* (mm)
SOLID COLORED END/SOLID COLORED END WITH BLACK EXTERIOR/WHITE INTERIOR						
TGM-DC-36-SC/SC-B-W	2	6	7.0	540 (245)	36¼ x 39 x 49½	921 x 991 x 1248
TGM-DC-48-SC/SC-B-W	2	6	7.0	660 (300)	48¼ x 39 x 49½	1226 x 991 x 1248
TGM-DC-59-SC/SC-B-W	2	6	7.0	660 (300)	59¼ x 39 x 49½	1505 x 991 x 1248
TGM-DC-77-SC/SC-B-W	2	6	7.0	825 (375)	77¼ x 39 x 49½	1962 x 991 x 1248
SOLID COLORED END/SOLID COLORED END WITH WHITE EXTERIOR/WHITE INTERIOR						
TGM-DC-36-SC/SC-W-W	2	6	7.0	540 (245)	36¼ x 39 x 49½	921 x 991 x 1248
TGM-DC-48-SC/SC-W-W	2	6	7.0	660 (300)	48¼ x 39 x 49½	1226 x 991 x 1248
TGM-DC-59-SC/SC-W-W	2	6	7.0	660 (300)	59¼ x 39 x 49½	1505 x 991 x 1248
TGM-DC-77-SC/SC-W-W	2	6	7.0	825 (375)	77¼ x 39 x 49½	1962 x 991 x 1248
SOLID COLORED END/SOLID COLORED END WITH STAINLESS EXTERIOR/WHITE INTERIOR						
TGM-DC-36-SC/SC-S-W	2	6	7.0	540 (245)	36¼ x 39 x 49½	921 x 991 x 1248
TGM-DC-48-SC/SC-S-W	2	6	7.0	660 (300)	48¼ x 39 x 49½	1226 x 991 x 1248
TGM-DC-59-SC/SC-S-W	2	6	7.0	660 (300)	59¼ x 39 x 49½	1505 x 991 x 1248
TGM-DC-77-SC/SC-S-W	2	6	7.0	825 (375)	77¼ x 39 x 49½	1962 x 991 x 1248
SOLID COLORED END/SOLID COLORED END WITH STAINLESS EXTERIOR/STAINLESS INTERIOR						
TGM-DC-36-SC/SC-S-S	2	6	7.0	540 (245)	36¼ x 39 x 49½	921 x 991 x 1248
TGM-DC-48-SC/SC-S-S	2	6	7.0	660 (300)	48¼ x 39 x 49½	1226 x 991 x 1248
TGM-DC-59-SC/SC-S-S	2	6	7.0	660 (300)	59¼ x 39 x 49½	1505 x 991 x 1248
TGM-DC-77-SC/SC-S-S	2	6	7.0	825 (375)	77¼ x 39 x 49½	1962 x 991 x 1248

REFRIGERATED DELI CASES

White & Stainless Exterior

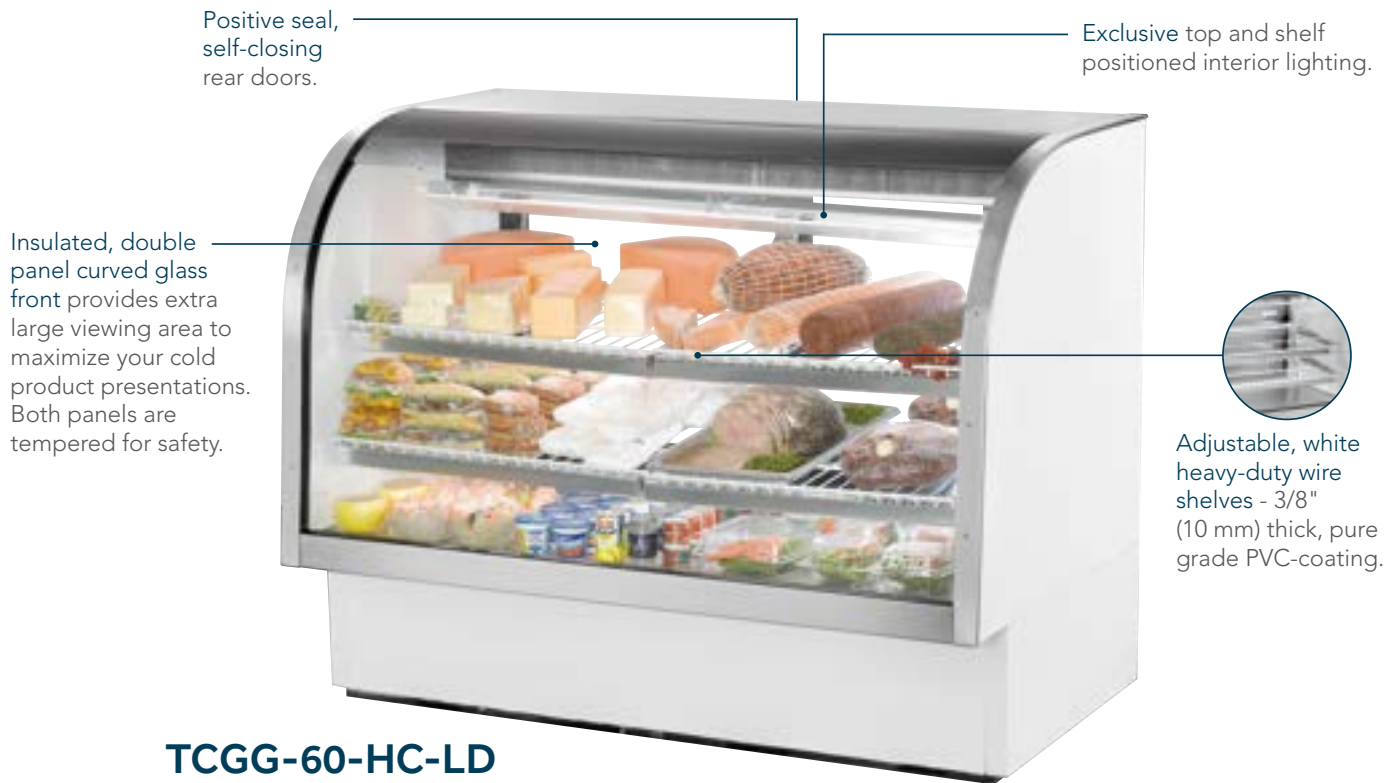

TCGG-60-HC-LD



TCGG-36-HC-LD



TCGG-48-HC-LD



TCGG-60-S-HC-LD



TCGG-77-S-HC-LD

Features/Benefits

- Refrigerator holds ideal 38°F to 40°F (3.3°C to 4.5°C) case temperature for fresher deli products.
 - Exterior - durable and permanent no peel or chip powder coated steel with stainless steel cabinet top and trim.
 - Interior - attractive, clear aluminum sides and top, stainless steel floor with coved corners.
 - LED interior lighting provides more even lighting throughout the cabinet. Safety shielded.
 - Energy efficient, "Low-E", thermal insulated glass rear doors provide maximum insulation.
 - 4 amp exterior scale receptacle.
 - Automatic defrost time clock.
 - Central electrical connections.
 - Space saving design.
 - Self-contained system.
 - Optional lighted and non-lighted stainless steel mezzanine shelves available.
 - Optional 2-1/2" (64mm) castors or 6" (153mm) legs available.
- Stainless Steel models have...**
- Stainless steel interior and exterior, stainless steel floor with coved corners.



TCGG™ REFRIGERATED DELI CASES

Model	# of Doors	# of Shelves	HP	Amps	Crated Weight lb. (kg.)	Cabinet Dimensions W D† H* (in)	Cabinet Dimensions W D† H* (mm)
WHITE EXTERIOR							
TCGG-36-HC-LD	2	2	1/3	3.3	400 (182)	36¼ x 35¼ x 47¾	921 x 896 x 1213
TCGG-48-HC-LD	2	2	1/3	3.3	550 (250)	48¼ x 35¼ x 47¾	1226 x 896 x 1213
TCGG-60-HC-LD	2	4	1/2	5.3	550 (250)	60¼ x 35¼ x 47¾	1531 x 896 x 1213
TCGG-72-HC-LD	2	2	1/2	5.3	725 (329)	72¼ x 35¼ x 47¾	1836 x 896 x 1213
STAINLESS EXTERIOR							
TCGG-36-S-HC-LD	2	2	1/3	3.3	400 (182)	36¼ x 35¼ x 47¾	921 x 896 x 1213
TCGG-48-S-HC-LD	2	2	1/3	3.3	465 (211)	48¼ x 35¼ x 47¾	1226 x 896 x 1213
TCGG-60-S-HC-LD	2	4	1/2	5.3	555 (252)	60¼ x 35¼ x 47¾	1531 x 896 x 1213
TCGG-72-S-HC-LD	2	2	1/2	5.3	730 (331)	72¼ x 35¼ x 47¾	1836 x 896 x 1213

Environmentally friendly R290 hydrocarbon refrigeration system for the best in food preservation.





MILK COOLERS



True Milk Coolers provide safer, better-tasting milk with colder holding temperatures for less spoilage. Each features conveniently designed self-service drop-front and flip-top doors. True's forced-air advantage allows milk products to remain cold even with access doors open.





MILK COOLERS

Single & Dual-Sided



TMC-58-DS-SS-HC



TMC-34-S-DS-SS-HC



TMC-49-HC



TMC-49-S-DS-SS-HC



TMC-58-S-SS-HC

Features/Benefits

- High capacity, factory balanced, forced-air refrigeration system maintains milk temperatures of 33°F to 38°F (.5°C to 3.3°C). Colder holding temperatures provide better tasting milk, increased sales and less product waste..
- Exterior - white or stainless steel exterior front, sides, back and top.
- Interior - Stainless steel walls and reinforced floor.
- Standard with heavy duty floor racks and convenient clean out drain.
- Entire cabinet structure is foamed-in-place using a high density, polyurethane insulation that has zero ozone depletion potential (ODP) and zero global warming potential (GWP).
- Magnetic door gaskets of one piece construction, removable without tools for ease of cleaning.
- All stainless steel self-service doors feature convenient drop front and "hold-open" flip-up top. Door support bumpers standard.
- NSF/ANSI Standard 7 compliant for the storage and/or display of packaged or bottled product.
- Convenient clean out drain with ½" (13mm) NPT-PVC drain plug.
- Condensing unit accessed from behind back grill, slides out for easy cleaning and maintenance.



TMC™ SINGLE-SIDED MILK COOLERS

Model	# of Doors	Capacity - Milk Crates	# of Floor Racks	HP	Amps	Crated Weight lb. (kg.)	Cabinet Dimensions W** D† H* (in)	Cabinet Dimensions W** D† H* (mm)
WHITE & STAINLESS STEEL EXTERIOR/CLEAR ALUMINUM INTERIOR								
TMC-34-HC	2	8	2	½	2.7	305 (139)	34 x 33 x 41½	864 x 839 x 1058
TMC-49-HC	2	12	3	½	2.7	380 (173)	49 x 33 x 41½	1245 x 839 x 1058
TMC-58-HC	2	16	3	½	2.7	425 (193)	58 x 33 x 41½	1474 x 839 x 1058
STAINLESS STEEL EXTERIOR/CLEAR ALUMINUM INTERIOR								
TMC-34-S-HC	2	8	2	½	2.7	290 (132)	34 x 33 x 41½	864 x 839 x 1058
TMC-49-S-HC	2	12	3	½	2.7	365 (166)	49 x 33 x 41½	1245 x 839 x 1058
TMC-58-S-HC	2	16	3	½	2.7	410 (186)	58 x 33 x 41½	1474 x 839 x 1058
WHITE & STAINLESS STEEL EXTERIOR/STAINLESS STEEL INTERIOR								
TMC-34-SS-HC	2	8	2	½	2.7	360 (164)	34 x 33 x 41½	864 x 839 x 1058
TMC-49-SS-HC	2	12	3	½	2.7	395 (180)	49 x 33 x 41½	1245 x 839 x 1058
TMC-58-SS-HC	2	16	3	½	2.7	440 (200)	58 x 33 x 41½	1474 x 839 x 1058
STAINLESS STEEL EXTERIOR/STAINLESS STEEL INTERIOR								
TMC-34-S-SS-HC	2	8	2	½	2.7	345 (157)	34 x 33 x 41½	864 x 839 x 1058
TMC-49-S-SS-HC	2	12	3	½	2.7	430 (195)	49 x 33 x 41½	1245 x 839 x 1058
TMC-58-S-SS-HC	2	16	3	½	2.7	445 (202)	58 x 33 x 41½	1474 x 839 x 1058

**Width does not include ½" (4mm) each side for lid pins.

† Depth does not include 1" (26 mm) each for side bumpers.

* Height does not include 5½" (130 mm) for castors.

note: Milk crate dimensions: L=13" (331mm)/D=13 (331mm)/H=11½"(296mm).

TMC™ DUAL-SIDED MILK COOLERS

Model	# of Doors	Capacity - Milk Crates	# of Floor Racks	HP	Amps	Crated Weight lb. (kg.)	Cabinet Dimensions W** D† H* (in)	Cabinet Dimensions W** D† H* (mm)
WHITE & STAINLESS STEEL EXTERIOR/CLEAR ALUMINUM INTERIOR								
TMC-34-DS-HC	4	8	2	½	2.7	320 (146)	34 x 33 x 41½	864 x 839 x 1058
TMC-49-DS-HC	4	12	3	½	2.7	395 (180)	49 x 33 x 41½	1245 x 839 x 1058
TMC-58-DS-HC	4	16	3	½	2.7	440 (200)	58 x 33 x 41½	1474 x 839 x 1058
STAINLESS STEEL EXTERIOR/CLEAR ALUMINUM INTERIOR								
TMC-34-S-DS-HC	4	8	2	½	2.7	360 (164)	34 x 33 x 41½	864 x 839 x 1058
TMC-49-S-DS-HC	4	12	3	½	2.7	405 (184)	49 x 33 x 41½	1245 x 839 x 1058
TMC-58-S-DS-HC	4	16	3	½	2.7	485 (220)	58 x 33 x 41½	1474 x 839 x 1058
WHITE & STAINLESS STEEL EXTERIOR/STAINLESS STEEL INTERIOR								
TMC-34-DS-SS-HC	4	8	2	½	2.7	350(159)	34 x 33 x 41½	864 x 839 x 1058
TMC-49-DS-SS-HC	4	12	3	½	2.7	400 (182)	49 x 33 x 41½	1245 x 839 x 1058
TMC-58-DS-SS-HC	4	16	3	½	2.7	460 (209)	58 x 33 x 41½	1474 x 839 x 1058
STAINLESS STEEL EXTERIOR/STAINLESS STEEL INTERIOR								
TMC-34-S-DS-SS-HC	4	8	2	½	2.7	355 (162)	34 x 33 x 41½	864 x 839 x 1058
TMC-49-S-DS-SS-HC	4	12	3	½	2.7	425 (193)	49 x 33 x 41½	1245 x 839 x 1058
TMC-58-S-DS-SS-HC	4	16	3	½	2.7	485 (220)	58 x 33 x 41½	1474 x 839 x 1058

**Width does not include ½" (4mm) each side for lid pins.

† Depth does not include 1" (26 mm) each for side bumpers.

* Height does not include 5½" (130 mm) for castors.

note: Milk crate dimensions: L=13" (331mm)/D=13 (331mm)/H=11½"(296mm).

Environmentally friendly R290 hydrocarbon refrigeration system for the best in food preservation.





HEATED CABINETS



Heated holding cabinets provide a consistent heat designed to keep baked and cooked food warm. Low-velocity fans evenly circulate air to keep the food warm, while the top vent can be adjusted to control the humidity levels, so food doesn't dry out.



TRUVE

Bottom Mount Reach-Ins | TH Series

HEATED CABINETS *Solid & Glass Doors*

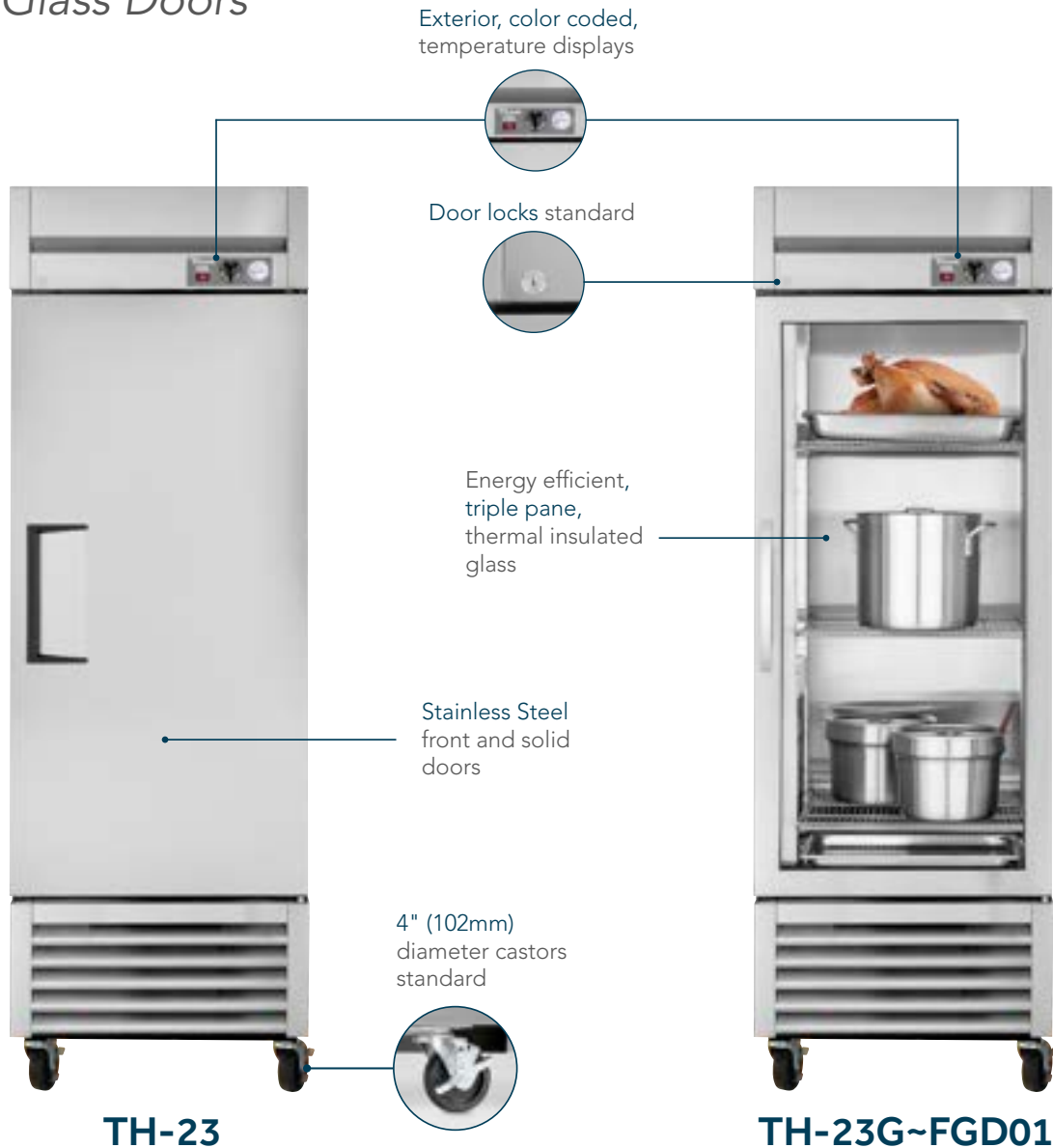

Features/Benefits

- Powerful forced-air heating provides holding temperatures of 80°F (22.7°C) to 180°F (82.2°C) uniformly throughout the cabinet.
- Low velocity fans assure even temperature throughout cabinet. A vent is located at the top of the cabinet for positive humidity control.
- Heater - sheathed for corrosion resistance.
- 12" x 20" (305mm x 508mm) water pan standard for contents requiring high humidity.
- Adjustable dial control is a standard feature for low humidity application (turn counter clockwise to ventilate).
- Adjustable, heavy-duty chrome-plated shelves.
- Positive seal self-closing doors with factory tested (over 1,000,000 times) lifetime guaranteed door hinges and torsion type closure system.
- Incandescent interior lighting, safety shielded.
- Self-contained system - simple installation. Equipped with 9-foot cord.
- Stainless Steel front. Anodized quality aluminum ends. Corrosion resistant GalFan coated steel back.
- Bun tray rack (optional) - solid door heated cabinet interior accommodates this option (glass door model does not accommodate this option).



TH SERIES HEATED CABINETS

Model	# of Doors	# of Shelves	Watts	Amps	Crated Weight lb. (kg.)	Cabinet Dimensions W D† H* (in)	Cabinet Dimensions W D† H* (mm)
SOLID DOORS							
TH-23	1	3	850	7.8	260 (118)	27 x 29½ x 78¾	686 x 750 x 1991
GLASS DOORS							
TH-23G~FGD01	1	3	850	7.8	290 (132)	27 x 29½ x 78¾	686 x 750 x 1991

† Depth does not include 1¾" (35 mm) for door handles (glass door model only).
 * Height does not include 5" (127mm) for castors or 6" (153mm) for optional legs.
 * Height does not include 1" (26mm) for ventilator cap.

Top Mount Reach-Ins | SPEC SERIES® Heated Cabinets

STR/STA/STG REACH-IN & PASS-THRU HEATED CABINETS

Solid & Glass, Full & Half Doors

Lifetime guaranteed
bolt style door locks

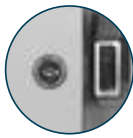

Lifetime guaranteed
heavy-duty, all metal
working door handles

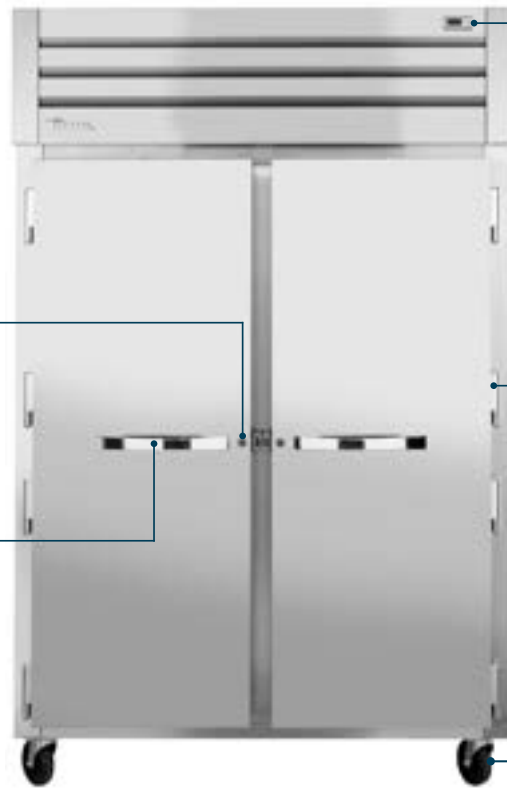

STR2H-2S

Exterior digital
temperature display
standard for easy visibility



Positive seal self-closing door with
120° stay open feature. Lifetime
guaranteed external cam lift door
hinges, four (4) per door section

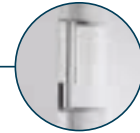

5" (127 mm) diameter
plate castors - locks
provided on front set



STG1H-2HS



STR2H-2S



STA2H-2G



STG2HPT-2S-2S

Features/Benefits

- Cabinet designed to provide holding temperatures of 140°F to 180°F (60°C to 82.2°C). Heating system controlled by exterior on/off switch and electronic temperature control.
- One (1) stainless steel (for corrosion resistance) heating element per section for uniform generation of electric heat. 1500 Watts per heating element.
- ANSI/NSF Standard 4 compliant for open food product.
- Pilasters and tray slides/shelving are factory installed at no charge on STR units.
- Incandescent interior lighting.
- Energy efficient, "Low-E", thermal insulated glass doors on glass door models.
- Extruded, aluminum door frames on glass doors.
- STR & STA Series Exterior - Stainless steel door, front & sides.
- STG Series Exterior - stainless steel doors & front, with matching aluminum sides.
- STR Series Interior - Stainless steel side walls, back, floor, door liner, & ceiling.
- STA & STG Series Interior - Aluminum side walls & back. Stainless steel floor & ceiling.
- Self-contained system.



STR/STA/STG REACH-IN HEATED CABINETS

Model	# of Doors	# of Shelves STA/STG models	Watts	Crated Weight lb. (kg.)	Cabinet Dimensions W D† H* (in)	Cabinet Dimensions W D† H* (mm)
SOLID DOORS						
STR1H-1S†	1	3	1500	350 (159)	27½ x 33¾ x 77¾	699 x 858 x 1975
STR2H-2S††	2	6	3000	570 (259)	52½ x 33¾ x 77¾	1337 x 858 x 1975
SOLID HALF DOORS						
STR1H-2HS†	2	3	1500	385 (175)	27½ x 33¾ x 77¾	699 x 858 x 1975
STR2H-4HS††	4	6	3000	650 (295)	52½ x 33¾ x 77¾	1337 x 858 x 1975
GLASS DOORS						
STR1H-1G†	1	3	1500	370 (168)	27½ x 33¾ x 77¾	699 x 858 x 1975
STR2H-2G††	2	6	3000	N/A	52½ x 33¾ x 77¾	1337 x 858 x 1975
GLASS HALF DOORS						
STR1H-2HG†	2	3	1500	370 (168)	27½ x 33¾ x 77¾	699 x 858 x 1975
STR2H-4HG††	4	6	3000	650 (295)	52½ x 33¾ x 77¾	1337 x 858 x 1975

† Depth does not include 1½" (39 mm) for door handles.

* Height does not include 6½" (156mm) for castors or 6" (153mm) for optional legs.

* Height does not include ¼" (7mm) for system mechanical components.

† Requires 208-240/60 single phase, 15 amp dedicated outlet for single section heated cabinets.

†† Requires 208-240/60 single phase, 20 amp dedicated circuit for two section heated cabinets. Two section heated cabinets require hard wiring.

note: Crated weight listed on the chart is for STR model, STA & STG versions may have different weights.

STR/STA/STG PASS-THRU HEATED CABINETS

Model	# of Doors	# of Shelves STA/STG models	Watts	Crated Weight lb. (kg.)	Cabinet Dimensions W D† H* (in)	Cabinet Dimensions W D† H* (mm)
SOLID DOORS						
STR1HPT-1S-1S†	1 fr / 1 bk	3	1500	400 (182)	27½ x 36½ x 77¾	699 x 918 x 1975
STR2HPT-2S-2S††	2 fr / 2 bk	6	3000	680 (309)	52½ x 36½ x 77¾	1337 x 918 x 1975
SOLID HALF DOORS						
STR1HPT-1G-1S†	1 fr / 1 bk	3	1500	400 (182)	27½ x 36½ x 77¾	699 x 918 x 1975
STR2HPT-2G-2S††	2 fr / 2 bk	6	3000	650 (295)	52½ x 36½ x 77¾	1337 x 918 x 1975

† Depth does not include 1½" (39 mm) for door handles.

* Height does not include 6½" (156mm) for castors or 6" (153mm) for optional legs.

* Height does not include ¼" (7mm) for system mechanical components.

† Requires 208-240/60 single phase, 15 amp dedicated outlet for single section heated cabinets.

†† Requires 208-240/60 single phase, 20 amp dedicated circuit for two section heated cabinets. Two section heated cabinets require hard wiring.

note: Crated weight listed on the chart is for STR model, STA & STG versions may have different weights.

Series Shelving

STR Series Shelving - (1) interior kit option included per full section at no charge.

(4) different interior kits available.

STA Series Shelving - (3) heavy-duty, chrome-plated wire shelves per section.

(4) different interior kits available.

STG Series Shelving - (3) heavy-duty, PVC-coated wire shelves per section.

(4) different interior kits available.

See "Spec Series accessories" (pg. 211) for additional details.

Top Mount Reach-Ins | SPEC SERIES® Heated Cabinets

STR/STA/STG ROLL-IN & ROLL-THRU HEATED CABINETS

Solid, Full Doors



STR1HRI-1S



STA1HRT-1S-1S



STG2HRT-2S-2S



STR2HRI-2S



STR1HRI89-1S

Features/Benefits

- Cabinet designed to provide holding temperatures of 140°F to 180°F (60°C to 82.2°C). Heating system controlled by exterior on/off switch and electronic temperature control.
- Accepts roll-in rack (inboard castor) with maximum dimensions of 27"W x 29"D x 66"H (686mm x 737mm x 1,677mm). STR/STA/STG1RRI89-1S and STR/STA/STG2RRI89-2S accept roll-in rack (inboard castor) with maximum dimensions of 27"W x 29"D x 72"H (686mm x 737mm x 1,829mm) (supplied by others).
- One (1) stainless steel (for corrosion resistance) heating element per section for uniform generation of electric heat. 1500 Watts per heating element.
- ANSI/NSF Standard 4 compliant for open food product.
- Pilasters and tray slides/shelving are factory installed at no charge on STR units.
- Positive seal self-closing door with 120° stay open feature. Lifetime guaranteed external cam lift door hinges, four (4) per door section.
- Incandescent interior lighting.
- Energy efficient, "Low-E", thermal insulated glass doors on glass door models.
- Extruded, aluminum door frames on glass doors.
- STR & STA Series Exterior - Stainless steel door, front & sides.
- STG Series Exterior - stainless steel doors & front, with matching aluminum sides.
- STR Series Interior - Stainless steel side walls, back, floor, door liner, & ceiling.
- STA & STG Series Interior - Aluminum side walls & back. Stainless steel floor & ceiling.
- Self-contained system.



STR/STA/STG ROLL-IN HEATED CABINETS

Model	# of Doors	Watts	Crated Weight lb. (kg.)	Cabinet Dimensions W D† H* (in)	Cabinet Dimensions W D† H* (mm)
SOLID DOORS					
STR1HRI-1S‡	1	2000	445 (202)	35 x 34¾ x 83¾	889 x 883 x 1975
STR2HRI-2S	2	4000	760 (345)	68 x 34¾ x 83¾	1723 x 883 x 1975
SOLID DOORS 89" HIGH					
STR1HRI89-1S	1	2000	380 (173)	35 x 34¾ x 88¾	889 x 883 x 2255

† Depth does not include 4¼" (108 mm) for ramp.

* Height does not include ¼" (7mm) for system mechanical components.

‡ Requires 115/208-240/60/1 Hz, single phase, 20 amp dedicated outlet.

note: STR/STA/STG2HRI-2S requires hard wiring.

note: Crated weight listed on the chart is for STR model, STA & STG versions may have different weights.

STR/STA/STG ROLL-THRU HEATED CABINETS

Model	# of Doors	Watts	Crated Weight lb. (kg.)	Cabinet Dimensions W D† H* (in)	Cabinet Dimensions W D† H* (mm)
SOLID DOORS					
STR1HRT-1S-1S‡	1 fr / 1 bk	2000	480 (218)	35 x 37½ x 83¾	889 x 953 x 1975
STR2HRT-2S-2S	2 fr / 2 bk	4000	825 (375)	68 x 37½ x 83¾	1337 x 953 x 1975
SOLID HALF DOORS					
STR1HRT89-1S-1S‡	1 fr / 1 bk	2000	480 (218)	35 x 37½ x 88¾	889 x 953 x 2255

† Depth does not include 4¼" (108 mm) for ramp.

* Height does not include ¼" (7mm) for system mechanical components.

‡ Requires 115/208-240/60/1 Hz, single phase, 20 amp dedicated outlet.

note: STR/STA/STG2HRT-2S-2S requires hard wiring.

note: Crated weight listed on the chart is for STR model, STA & STG versions may have different weights.



BAR REFRIGERATION



True's line of bar refrigerators offers multiple options to choose from. Whether it's temperature range, door type, or lighting color, True Bar refrigerators can be customized to fit the functionality and style of any bar.

TBR™/TDR™ NOMENCLATURE

Model Family

TBR™ | True Bar Refrigerator

TDR™ | True Draft Refrigerator

Type

RI | Reach-In

PT | Pass Thru

RO | Reach-In Panel Ready

PO | Pass Thru Panel Ready

Refrigeration System Side

L | Left

R | Right

Front Side Cabinet Type

S | Solid

G | Glass

1 | Sliding Glass

TBR72-RISZ1-L-B-GGG-1

Length

32" | 36" | One Section

48" | 52" | 60" | Two Section

72" | 84" | Three Section

92" | 108" | Four Section

Temperature

SZ1 | Single Zone (35°F)

SZ2 | Single Zone (55°F)

SZ3 | Single Zone (45°F)

Main Cabinet Finish

B | Black (Black Cabinet/
SS Countertop)

Z | Black (Black Cabinet/
Black Countertop*)

S | Stainless Steel

X | Custom

Voltage

1 | 115/60 Hz

2 | 220-40 / 50-60 Hz

***NOTE:** Black countertops not offered on the 108" models.



BAR REFRIGERATION REACH-IN & PASS-THRU, BLACK EXTERIOR

Solid & Glass, Swing & Slide Doors



TBR48-RISZ1-L-B-SS-1



TBR60-RISZ1-L-B-GG-1



TBR72-RISZ1-L-B-SSS-1



TBR108-RISZ1-L-B-GGGG-1

Features/Benefits

- Maintains cold 33°F to 38°F (0.5°C to 3.3°C) product temperatures.
 - Exterior - Black, powder coated cold-rolled steel with stainless steel countertop.
 - Interior - stainless steel floor and sides.
 - White LED Interior Lighting standard on solid door models. (14-color TruLumina® optional)
 - NSF/ANSI Standard 7 compliant for open food product.
 - Front Air Intake & Front Air Discharge.
 - 24" (610mm) depth makes for easy placement in tight areas. Conserves valuable work space.
 - Positive seal doors. (Excludes slide door models)
 - Each cabinet designed to accommodate a variety of beer kegs.
 - Leg levelers standard with 7 other castor/leg options for various heights.
 - Three (3) interior access ports.
 - All TBR models also available in right side compressor versions.
- Glass door models only...**
- Energy efficient, "Low-E", thermal glass doors.
 - 14-color TruLumina® standard on all glass door models.
- Pass-Thru models only...**
- Designed for convenient front and rear access for serving.



TBR™ BAR REFRIGERATION REACH-IN, BLACK EXTERIOR

Model	# of Doors	# of Shelves	HP	Amps	Crated Weight lb. (kg.)	Cabinet Dimensions W D† H* (in)	Cabinet Dimensions W D† H* (mm)
SOLID SWING DOORS & LEFT SIDE REFRIGERATION SYSTEM							
TBR32-RISZ1-L-B-S-1	1	3	½	1.8	240 (109)	32 x 24⅞ x 34¾	813 x 631 x 881
TBR36-RISZ1-L-B-S-1	1	3	½	1.8	255 (116)	36 x 24⅞ x 34¾	914 x 631 x 881
TBR48-RISZ1-L-B-SS-1	2	6	½	1.8	320 (145)	48 x 24⅞ x 34¾	1219 x 631 x 881
TBR52-RISZ1-L-B-SS-1	2	6	½	1.8	355 (161)	52 x 24⅞ x 34¾	1321 x 631 x 881
TBR60-RISZ1-L-B-SS-1	2	6	¾	3.2	380 (173)	60 x 24⅞ x 34¾	1524 x 631 x 881
TBR72-RISZ1-L-B-SSS-1	3	9	¾	3.2	435 (198)	72 x 24⅞ x 34¾	1829 x 631 x 881
TBR84-RISZ1-L-B-SSS-1	3	9	¾	3.2	470 (214)	84 x 24⅞ x 34¾	2134 x 631 x 881
TBR92-RISZ1-L-B-SSSS-1	4	12	¾	3.2	510 (232)	92 x 24⅞ x 34¾	2337 x 631 x 881
TBR108-RISZ1-L-B-SSSS-1	4	12	¾	3.2	595 (270)	108 x 24⅞ x 34¾	2744 x 631 x 881
GLASS SWING DOORS & LEFT SIDE REFRIGERATION SYSTEM							
TBR32-RISZ1-L-B-G-1	1	3	½	1.8	245 (112)	32 x 24⅞ x 34¾	813 x 631 x 881
TBR36-RISZ1-L-B-G-1	1	3	½	1.8	285 (130)	36 x 24⅞ x 34¾	915 x 631 x 881
TBR48-RISZ1-L-B-GG-1	2	6	½	1.8	335 (152)	48 x 24⅞ x 34¾	1219 x 631 x 881
TBR52-RISZ1-L-B-GG-1	2	6	½	1.8	350 (159)	52 x 24⅞ x 34¾	1321 x 631 x 881
TBR60-RISZ1-L-B-GG-1	2	6	¾	3.2	390 (177)	60 x 24⅞ x 34¾	1524 x 631 x 881
TBR72-RISZ1-L-B-GGG-1	3	9	¾	3.2	445 (202)	72 x 24⅞ x 34¾	1829 x 631 x 881
TBR84-RISZ1-L-B-GGG-1	3	9	¾	3.2	470 (214)	84 x 24⅞ x 34¾	2134 x 631 x 881
TBR92-RISZ1-L-B-GGGG-1	4	12	¾	3.2	510 (232)	92 x 24⅞ x 34¾	2337 x 631 x 881
TBR108-RISZ1-L-B-GGGG-1	4	12	¾	3.2	610 (277)	108 x 24⅞ x 34¾	2744 x 631 x 881
GLASS SLIDE DOORS & LEFT SIDE REFRIGERATION SYSTEM							
TBR48-RISZ1-L-B-11-1	2	6	½	1.8	325 (148)	48 x 24⅞ x 34¾	1219 x 631 x 881
TBR52-RISZ1-L-B-11-1	2	6	½	1.8	350 (159)	52 x 24⅞ x 34¾	1321 x 631 x 881
TBR60-RISZ1-L-B-11-1	2	6	¾	3.2	385 (175)	60 x 24⅞ x 34¾	1524 x 631 x 881
TBR72-RISZ1-L-B-111-1	3	9	¾	3.2	445 (202)	72 x 24⅞ x 34¾	1829 x 631 x 881

† Depth does not include 1½" (35mm) for swing door handles, ¾" (16mm) for slide door handles.

TBR™ BAR REFRIGERATION PASS-THRU, BLACK EXTERIOR

Model	# of Doors	# of Shelves	HP	Amps	Crated Weight lb. (kg.)	Cabinet Dimensions W D† H* (in)	Cabinet Dimensions W D† H* (mm)
SOLID SWING DOORS (FRONT & REAR), LEFT SIDE REFRIGERATION SYSTEM							
TBR36-PTSZ1-L-B-S-S-1	2	3	½	1.8	265 (121)	36 x 27 x 34¾	915 x 684 x 881
TBR60-PTSZ1-L-B-SS-SS-1	4	6	¾	3.2	395 (180)	60 x 27 x 34¾	684 x 684 x 881
TBR84-PTSZ1-L-B-SSS-SSS-1	6	9	¾	3.2	470 (214)	84 x 27 x 34¾	2134 x 684 x 881
GLASS SWING DOORS (FRONT & REAR), LEFT SIDE REFRIGERATION SYSTEM							
TBR36-PTSZ1-L-B-G-G-1	2	3	½	1.8	265 (121)	36 x 27 x 34¾	915 x 684 x 881
TBR60-PTSZ1-L-B-GG-GG-1	4	6	¾	3.2	395 (180)	60 x 27 x 34¾	1524 x 684 x 881
TBR84-PTSZ1-L-B-GGG-GGG-1	3	9	¾	3.2	555 (252)	84 x 24⅞ x 34¾	2134 x 631 x 881
GLASS SLIDE DOORS (FRONT & REAR), LEFT SIDE REFRIGERATION SYSTEM							
TBR60-PTSZ1-L-B-11-11-1	2	6	¾	3.2	395 (180)	60 x 24⅞ x 34¾	1524 x 631 x 881

† Depth does not include 1½" (35mm) for swing door handles, ¾" (16mm) for slide door handles.

Environmentally friendly R290 hydrocarbon refrigeration system for the best in food preservation.



BAR REFRIGERATION REACH-IN & PASS-THRU, STAINLESS EXTERIOR *Solid & Glass, Swing & Slide Doors*



TBR48-RISZ1-L-S-GG-1



TBR52-RISZ1-L-S-11-1



TBR60-RISZ1-L-S-SS-1



TBR72-RISZ1-L-S-GGG-1

Features/Benefits

- Maintains cold 33°F to 38°F (0.5°C to 3.3°C) product temperatures.
 - Exterior - Stainless steel exterior for those who appreciate the value of stainless.
 - Interior - stainless steel floor and sides.
 - White LED Interior Lighting standard on solid door models. (optional 14-color TruLumina®)
 - NSF/ANSI Standard 7 compliant for open food product.
 - Front Air Intake & Front Air Discharge.
 - 24" (610mm) depth makes for easy placement in tight areas. Conserves valuable work space.
 - Positive seal doors. (Excludes slide door models)
 - Each cabinet designed to accommodate a variety of beer kegs. See our beer keg footprint brochure on our website.
 - Leg levelers standard with 7 other castor/leg options for various heights.
 - Three (3) interior access ports.
 - All TBR models also available in right side compressor versions.
- Glass door models only...**
- Energy efficient, "Low-E", thermal glass doors.
 - 14-color TruLumina® standard on all glass door models.
- Pass-Thru models only...**
- Designed for convenient front and rear access for serving.



TBR™ BAR REFRIGERATION REACH-IN, STAINLESS EXTERIOR

Model	# of Doors	# of Shelves	HP	Amps	Crated Weight lb. (kg.)	Cabinet Dimensions W D† H* (in)	Cabinet Dimensions W D† H* (mm)
SOLID SWING DOORS & LEFT SIDE REFRIGERATION SYSTEM							
TBR32-RISZ1-L-S-S-1	1	3	½	1.8	240 (109)	32 x 24¾ x 34¾	813 x 631 x 881
TBR36-RISZ1-L-S-S-1	1	3	½	1.8	290 (132)	36 x 24¾ x 34¾	914 x 631 x 881
TBR48-RISZ1-L-S-SS-1	2	6	½	1.8	335 (152)	48 x 24¾ x 34¾	1219 x 631 x 881
TBR52-RISZ1-L-S-SS-1	2	6	½	1.8	355 (161)	52 x 24¾ x 34¾	1321 x 631 x 881
TBR60-RISZ1-L-S-SS-1	2	6	¾	3.2	395 (180)	60 x 24¾ x 34¾	1524 x 631 x 881
TBR72-RISZ1-L-S-SSS-1	3	9	¾	3.2	440 (200)	72 x 24¾ x 34¾	1829 x 631 x 881
TBR84-RISZ1-L-S-SSS-1	3	9	¾	3.2	470 (214)	84 x 24¾ x 34¾	2134 x 631 x 881
TBR92-RISZ1-L-S-SSSS-1	4	12	¾	3.2	510 (232)	92 x 24¾ x 34¾	2337 x 631 x 881
TBR108-RISZ1-L-S-SSSS-1	4	12	¾	3.2	630 (286)	108 x 24¾ x 34¾	2744 x 631 x 881
GLASS SWING DOORS & LEFT SIDE REFRIGERATION SYSTEM							
TBR32-RISZ1-L-S-G-1	1	3	½	1.8	290 (132)	32 x 24¾ x 34¾	813 x 631 x 881
TBR36-RISZ1-L-S-G-1	1	3	½	1.8	290 (132)	36 x 24¾ x 34¾	915 x 631 x 881
TBR48-RISZ1-L-S-GG-1	2	6	½	1.8	335 (152)	48 x 24¾ x 34¾	1219 x 631 x 881
TBR52-RISZ1-L-S-GG-1	2	6	½	1.8	365 (166)	52 x 24¾ x 34¾	1321 x 631 x 881
TBR60-RISZ1-L-S-GG-1	2	6	¾	3.2	395 (180)	60 x 24¾ x 34¾	1524 x 631 x 881
TBR72-RISZ1-L-S-GGG-1	3	9	¾	3.2	440 (200)	72 x 24¾ x 34¾	1829 x 631 x 881
TBR84-RISZ1-L-S-GGG-1	3	9	¾	3.2	470 (214)	84 x 24¾ x 34¾	2134 x 631 x 881
TBR92-RISZ1-L-S-GGGG-1	4	12	¾	3.2	510 (232)	92 x 24¾ x 34¾	2337 x 631 x 881
TBR108-RISZ1-L-S-GGGG-1	4	12	¾	3.2	610 (277)	108 x 24¾ x 34¾	2744 x 631 x 881
GLASS SLIDE DOORS & LEFT SIDE REFRIGERATION SYSTEM							
TBR48-RISZ1-L-S-11-1	2	6	½	1.8	330 (150)	48 x 24¾ x 34¾	1219 x 631 x 881
TBR52-RISZ1-L-S-11-1	2	6	½	1.8	350 (159)	52 x 24¾ x 34¾	1321 x 631 x 881
TBR60-RISZ1-L-S-11-1	2	6	¾	3.2	395 (180)	60 x 24¾ x 34¾	1524 x 631 x 881
TBR72-RISZ1-L-S-111-1	3	9	¾	3.2	450 (205)	72 x 24¾ x 34¾	1829 x 631 x 881

† Depth does not include 1½" (35mm) for swing door handles, ¾" (16mm) for slide door handles.

TBR™ BAR REFRIGERATION PASS-THRU, STAINLESS EXTERIOR

Model	# of Doors	# of Shelves	HP	Amps	Crated Weight lb. (kg.)	Cabinet Dimensions W D† H* (in)	Cabinet Dimensions W D† H* (mm)
SOLID SWING DOORS (FRONT & REAR), LEFT SIDE REFRIGERATION SYSTEM							
TBR36-PTSZ1-L-S-S-S-1	2	3	½	1.8	290 (132)	36 x 27 x 34¾	915 x 684 x 881
TBR60-PTSZ1-L-S-SS-SS-1	4	6	¾	3.2	395 (180)	60 x 27 x 34¾	1524 x 684 x 881
TBR84-PTSZ1-L-S-SSS-SSS-1	6	9	¾	3.2	470 (214)	84 x 27 x 34¾	2134 x 684 x 881
GLASS SWING DOORS (FRONT & REAR), LEFT SIDE REFRIGERATION SYSTEM							
TBR36-PTSZ1-L-S-G-G-1	2	3	½	1.8	290 (132)	36 x 27 x 34¾	915 x 684 x 881
TBR60-PTSZ1-L-S-GG-GG-1	4	6	¾	3.2	395 (180)	60 x 27 x 34¾	1524 x 684 x 881
TBR84-PTSZ1-L-S-GGG-GGG-1	3	9	¾	3.2	535 (243)	84 x 24¾ x 34¾	2134 x 631 x 881
GLASS SLIDE DOORS (FRONT & REAR), LEFT SIDE REFRIGERATION SYSTEM							
TBR60-PTSZ1-L-S-11-11-1	2	6	¾	3.2	395 (180)	60 x 24¾ x 34¾	1524 x 631 x 881

† Depth does not include 1½" (35mm) for swing door handles, ¾" (16mm) for slide door handles.

Environmentally friendly R290 hydrocarbon refrigeration system for the best in food preservation.



BACK BAR REACH-IN, STAINLESS TOP, BLACK & STAINLESS EXTERIOR *Solid & Glass, Swing Doors*

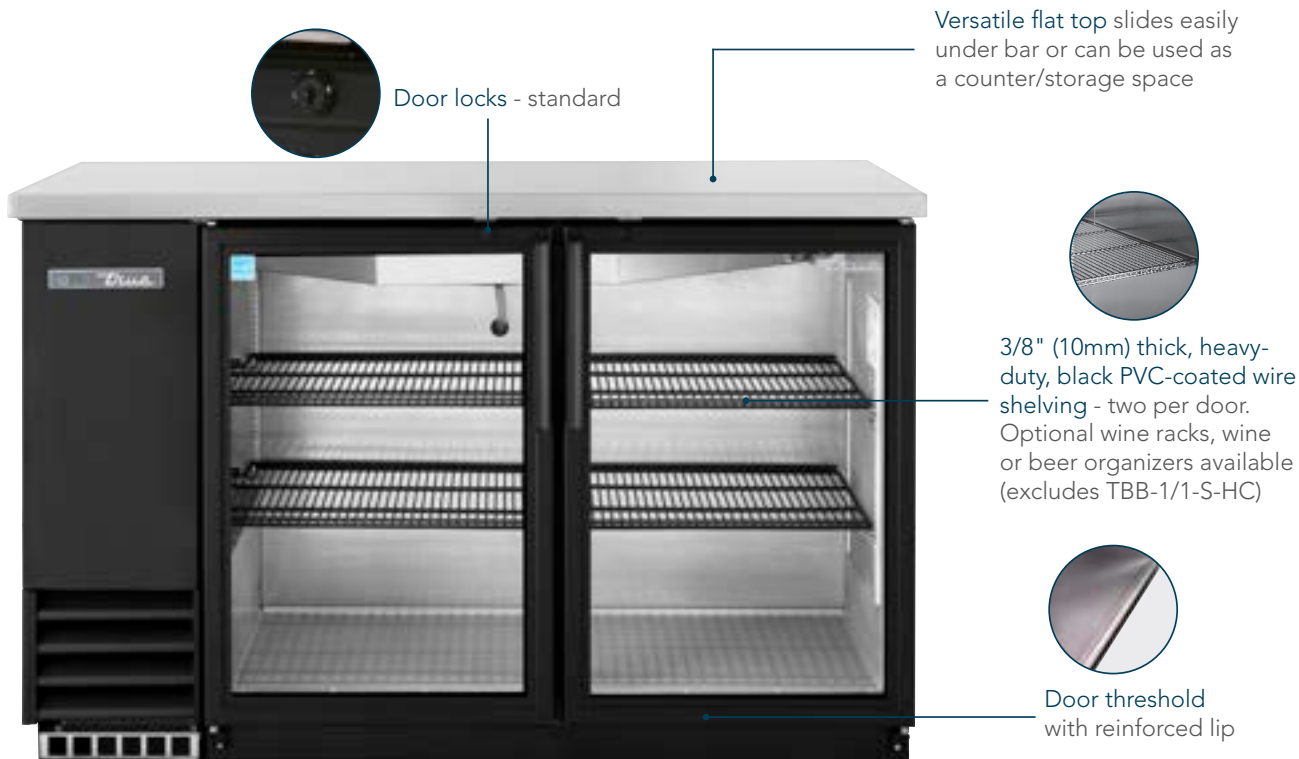

TBB-2G-HC-LD



TBB-1-HC



TBB-2G-S-HC



TBB-3G-HC



TBB-4PT-S

Features/Benefits

- Maintains cold 33°F to 38°F (0.5°C to 3.3°C) product temperatures.
- Exterior - Black, powder coated cold-rolled steel with stainless steel countertop.
- Interior - Stainless steel floor with ½" (13mm) lip & heavy galvanized steel walls.
- Recessed handles on solid door models.
- LED interior lighting.
- Air vents on side to maximize flow of fresh air through condenser.
- Positive seal doors.
- Self-contained installation.
- Available with optional legs or 2½" (64mm) or 4" (102mm) diameter castors (TBB-1 & TBB-1-S: 4" diameter castors standard equipment; 2½" (64mm) diameter castors & legs not available).

Glass door models have...

- Energy efficient, "Low-E", thermal glass doors.
- Extruded, aluminum door frames on glass doors.
- LED interior lighting provides more even lighting throughout the cabinet. Safety shielded.

Pass-Thru models have...

- Designed for convenient front and rear access for serving.

Stainless Steel models have...

- Heavy duty stainless steel exterior and countertop.



TBB® BACK BAR REACH-IN, STAINLESS TOP, BLACK EXTERIOR

Model	# of Doors	# of Shelves	HP	Amps	Crated Weight lb. (kg.)	Cabinet Dimensions W D† H* (in)	Cabinet Dimensions W D† H* (mm)
SOLID SWING DOORS							
TBB-1-HC	1	2	1/10	1.4	210 (96)	23½ x 31¾ x 38¾	597 x 810 x 985
TBB-2-HC	2	4	¼	2.8	360 (164)	58¾ x 27¾ x 37	1496 x 705 x 940
TBB-3-HC	2	4	¼	2.8	400 (182)	69½ x 27¾ x 37	1756 x 705 x 940
TBB-4-HC	3	6	¼	2.8	485 (220)	90¾ x 27¾ x 37	2296 x 705 x 940
GLASS SWING DOORS							
TBB-2G-HC-LD	2	4	¼	2.8	365 (166)	58¾ x 27¾ x 37	1496 x 705 x 940
TBB-3G-HC-LD	2	4	¼	2.8	440 (200)	69½ x 27¾ x 37	1756 x 705 x 940
TBB-4G-HC-LD	3	6	¼	2.8	595 (270)	90¾ x 27¾ x 37	2296 x 705 x 940

† Depth does not include 1¾" (35mm) for door handle (glass door models) or 1" (26mm) for rear bumpers (excludes TBB-1-HC).
 note: TBB-2G-HC-LD not available with door locks.

TBB® BACK BAR PASS-THRU, STAINLESS TOP, BLACK EXTERIOR

Model	# of Doors	# of Shelves	HP	Amps	Crated Weight lb. (kg.)	Cabinet Dimensions W D† H* (in)	Cabinet Dimensions W D† H* (mm)
SOLID SWING DOORS (FRONT & REAR)							
TBB-4PT-HC	3 fr / 3 bk	6	¼	2.9	580 (263)	90¾ x 31 x 37	2296 x 788 x 940

TBB® BACK BAR REACH-IN, STAINLESS TOP, STAINLESS EXTERIOR

Model	# of Doors	# of Shelves	HP	Amps	Crated Weight lb. (kg.)	Cabinet Dimensions W D† H* (in)	Cabinet Dimensions W D† H* (mm)
SOLID SWING DOORS							
TBB-1-S-HC	1	2	1/10	1.4	210 (96)	23½ x 31¾ x 38¾	597 x 810 x 985
TBB-2-S-HC	2	4	¼	2.8	385 (175)	58¾ x 27¾ x 37	1496 x 705 x 940
TBB-3-S-HC	2	4	¼	2.8	415 (189)	69½ x 27¾ x 37	1756 x 705 x 940
TBB-4-S-HC	3	6	¼	2.8	530 (241)	90¾ x 27¾ x 37	2296 x 705 x 940
GLASS SWING DOORS							
TBB-2G-S-HC-LD	2	4	¼	2.8	395 (180)	58¾ x 27¾ x 37	1496 x 705 x 940
TBB-3G-S-HC-LD	2	4	¼	2.8	440 (200)	69½ x 27¾ x 37	1756 x 705 x 940
TBB-4G-S-HC-LD	3	6	¼	2.8	595 (270)	90¾ x 27¾ x 37	2296 x 705 x 940

† Depth does not include 1¾" (35mm) for door handle (glass door models) or 1" (26mm) for rear bumpers (excludes TBB-1-S-HC).
 note: TBB-2G-S-HC-LD not available with door locks.

TBB® BACK BAR PASS-THRU, STAINLESS TOP, STAINLESS EXTERIOR

Model	# of Doors	# of Shelves	HP	Amps	Crated Weight lb. (kg.)	Cabinet Dimensions W D† H* (in)	Cabinet Dimensions W D† H* (mm)
SOLID SWING DOORS (FRONT & REAR)							
TBB-4PT-S-HC	3 fr / 3 bk	6	¼	2.9	585 (266)	90¾ x 31 x 37	2296 x 788 x 940

Environmentally friendly R290 hydrocarbon refrigeration system for the best in food preservation.



Bar Refrigeration | TBB[®]24

BACK BAR REACH-IN, STAINLESS TOP, BLACK & STAINLESS EXTERIOR *Solid & Glass, Swing Doors*

TBB24 models feature a finished stainless steel top (SFT) providing an excellent work or storage area, or a black sub-top (BST) feature designed to slide under existing cabinetry providing a built-in look

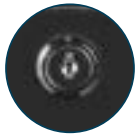

Door locks - standard

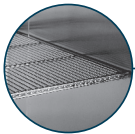
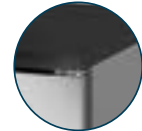

3/8" (10mm) thick, heavy-duty, PVC-coated wire shelving. Two shelves per door on two door models. Three door models feature two shelves for the right door and two long shelves which span both the left and center doors



TBB24-48-2G-Z1-SFT-B-1



TBB24-48-2S-Z1-BST-S-1



TBB24-60-2S-Z1-SFT-B-1



TBB24-60-2G-Z1-SFT-S-1



TBB24-72-3G-Z1-BST-B-1

Features/Benefits

- Maintains cold 33°F to 38°F (0.5°C to 3.3°C) product temperatures.
 - 24" (610mm) depth makes for easy placement in tight areas. Conserves valuable work space.
 - Exterior - Black, powder coated cold-rolled steel with stainless steel countertop or black sub-top..
 - Interior - Stainless steel floor with heavy gauge galvanized steel walls.
 - Recessed handles on solid door models.
 - Interior LED lighting.
 - NSF/ANSI Standard 7 compliant for packaged and bottle product.
 - Air vents on side to maximize flow of fresh air through condenser.
 - Optional wine racks, wine or beer organizers available.
 - Positive seal doors.
 - Self-contained system.
 - Ideal for bottle beer or can accommodate a variety of beer kegs.
 - Available with optional legs or 2½" (64mm) or 4" (102mm) diameter castors.
- Glass door models have...**
- Energy efficient, "Low-E", thermal glass doors.
 - Extruded, aluminum door frames on glass doors.
 - Glass doors fitted with flat top door handles.
- Stainless Steel models have...**
- Heavy duty stainless steel exterior and countertop.



TBB[®]24 BACK BAR REACH-IN, STAINLESS FINISHED TOP, BLACK EXTERIOR

Model	# of Doors	# of Shelves	HP	Amps	Crated Weight lb. (kg.)	Cabinet Dimensions W D† H* (in)	Cabinet Dimensions W D† H* (mm)
SOLID SWING DOORS							
TBB24-48-2S-Z1-SFT-B-1	2	4	1/5	1.8	290 (132)	48 7/8 x 24 7/8 x 34 3/4	1220 x 632 x 882
TBB24-60-2S-Z1-SFT-B-1	2	4	1/4	3.2	345 (157)	60 7/8 x 24 7/8 x 34 3/4	1525 x 632 x 882
TBB24-72-3S-Z1-SFT-B-1	3	6	1/4	3.2	415 (189)	72 7/8 x 24 7/8 x 34 3/4	1829 x 632 x 882
GLASS SWING DOORS							
TBB24-48-2G-Z1-SFT-B-1	2	4	1/5	1.8	290 (132)	48 7/8 x 24 7/8 x 34 3/4	1220 x 632 x 882
TBB24-60-2G-Z1-SFT-B-1	2	4	1/4	3.2	345 (157)	60 7/8 x 24 7/8 x 34 3/4	1525 x 632 x 882
TBB24-72-3G-Z1-SFT-B-1	3	6	1/4	3.2	415 (189)	72 7/8 x 24 7/8 x 34 3/4	1829 x 632 x 882

† Depth does not include 1 1/2" (39mm) for flat top door handle (glass door models).

* Height does not include 1/4" (7mm) for leg levelers.

TBB[®]24 BACK BAR REACH-IN, STAINLESS FINISHED TOP, STAINLESS EXTERIOR

Model	# of Doors	# of Shelves	HP	Amps	Crated Weight lb. (kg.)	Cabinet Dimensions W D† H* (in)	Cabinet Dimensions W D† H* (mm)
SOLID SWING DOORS							
TBB24-48-2S-Z1-SFT-S-1	2	4	1/5	1.8	290 (132)	48 7/8 x 24 7/8 x 34 3/4	1220 x 632 x 882
TBB24-60-2S-Z1-SFT-S-1	2	4	1/4	3.2	345 (157)	60 7/8 x 24 7/8 x 34 3/4	1525 x 632 x 882
TBB24-72-3S-Z1-SFT-S-1	3	6	1/4	3.2	415 (189)	72 7/8 x 24 7/8 x 34 3/4	1829 x 632 x 882
GLASS SWING DOORS							
TBB24-48-2G-Z1-SFT-S-1	2	4	1/5	1.8	290 (132)	48 7/8 x 24 7/8 x 34 3/4	1220 x 632 x 882
TBB24-60-2G-Z1-SFT-S-1	2	4	1/4	3.2	345 (157)	60 7/8 x 24 7/8 x 34 3/4	1525 x 632 x 882
TBB24-72-3G-Z1-SFT-S-1	3	6	1/4	3.2	415 (189)	72 7/8 x 24 7/8 x 34 3/4	1829 x 632 x 882

† Depth does not include 1 1/2" (39mm) for flat top door handle (glass door models).

* Height does not include 1/4" (7mm) for leg levelers.

TBB[®]24 BACK BAR REACH-IN, BLACK SUB-TOP, BLACK EXTERIOR

Model	# of Doors	# of Shelves	HP	Amps	Crated Weight lb. (kg.)	Cabinet Dimensions W D† H* (in)	Cabinet Dimensions W D† H* (mm)
SOLID SWING DOORS							
TBB24-48-2S-Z1-BST-B-1	2	4	1/5	1.8	290 (132)	48 7/8 x 24 7/8 x 34 1/4	1220 x 632 x 870
TBB24-60-2S-Z1-BST-B-1	2	4	1/4	3.2	345 (157)	60 7/8 x 24 7/8 x 34 1/4	1525 x 632 x 870
TBB24-72-3S-Z1-BST-B-1	3	6	1/4	3.2	415 (189)	72 7/8 x 24 7/8 x 34 1/4	1829 x 632 x 870
GLASS SWING DOORS							
TBB24-48-2G-Z1-BST-B-1	2	4	1/5	1.8	290 (132)	48 7/8 x 24 7/8 x 34 1/4	1220 x 632 x 870
TBB24-60-2G-Z1-BST-B-1	2	4	1/4	3.2	345 (157)	59 7/8 x 23 3/4 x 34 1/4	1521 x 616 x 870
TBB24-72-3G-Z1-BST-B-1	3	6	1/4	3.2	415 (189)	72 7/8 x 24 7/8 x 34 1/4	1829 x 632 x 870

† Depth does not include 1 1/2" (39mm) for flat top door handle (glass door models).

* Height does not include 1/4" (7mm) for leg levelers.

TBB[®]24 BACK BAR REACH-IN, BLACK SUB-TOP, STAINLESS EXTERIOR

Model	# of Doors	# of Shelves	HP	Amps	Crated Weight lb. (kg.)	Cabinet Dimensions W D† H* (in)	Cabinet Dimensions W D† H* (mm)
SOLID SWING DOORS							
TBB24-48-2S-Z1-BST-S-1	2	4	1/5	1.8	290 (132)	48 7/8 x 24 7/8 x 34 1/4	1220 x 632 x 870
TBB24-60-2S-Z1-BST-S-1	2	4	1/4	3.2	345 (157)	60 7/8 x 24 7/8 x 34 1/4	1525 x 632 x 870
TBB24-72-3S-Z1-BST-S-1	3	6	1/4	3.2	415 (189)	72 7/8 x 24 7/8 x 34 1/4	1829 x 632 x 870
GLASS SWING DOORS							
TBB24-48-2G-Z1-BST-S-1	2	4	1/5	1.8	290 (132)	48 7/8 x 24 7/8 x 34 1/4	1220 x 632 x 870
TBB24-60-2G-Z1-BST-S-1	2	4	1/4	3.2	345 (157)	60 7/8 x 24 7/8 x 34 1/4	1525 x 632 x 870
TBB24-72-3G-Z1-BST-S-1	3	6	1/4	3.2	415 (189)	72 7/8 x 24 7/8 x 34 1/4	1829 x 632 x 870

† Depth does not include 1 1/2" (39mm) for flat top door handle (glass door models).

* Height does not include 1/4" (7mm) for leg levelers.

Environmentally friendly R290 hydrocarbon refrigeration system for the best in food preservation.



DRAFT REFRIGERATION REACH-IN & PASS-THRU, BLACK EXTERIOR

Solid & Glass, Swing Doors

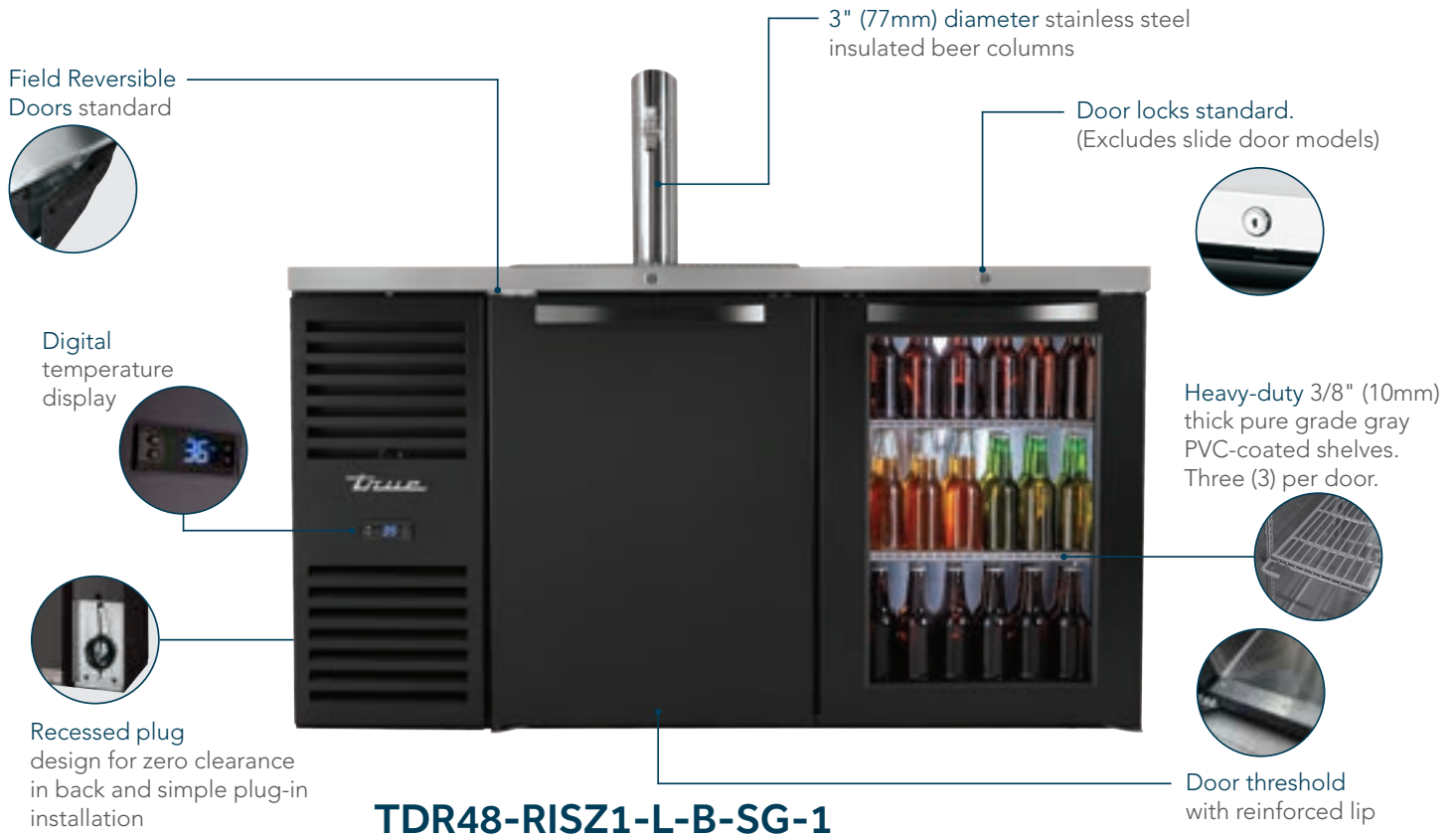

TDR48-RISZ1-L-B-SG-1



TDR32-RISZ1-L-B-S-1



TDR60-RISZ1-L-B-SS-1



TDR84-RISZ1-L-B-SSS-1



TDR108-RISZ1-L-B-SSSS-1

Features/Benefits

- Maintains cold 33°F to 38°F (0.5°C to 3.3°C) product temperatures.
 - Exterior - Black, powder coated cold-rolled steel with stainless steel countertop.
 - Interior - stainless steel floor and sides.
 - Insulated and chilled draft columns.
 - Fan motors direct large volume of cold air into draft columns.
 - White LED Interior Lighting for excellent visibility. (optional 14-color TruLumina® on glass and solid door combos)
 - NSF/ANSI Standard 7 compliant for packaged and bottled product.
 - Zero clearance recessed plug and front breathing.
 - 24" (610mm) depth makes for easy placement in tight areas. Conserves valuable work space.
 - Positive seal doors.
 - Each cabinet designed to accommodate a variety of beer kegs. See keg brochure on website for details.
 - Leg levelers standard with 7 other castor/leg options for various heights.
 - Three (3) interior access ports.
 - All TDR models also available in right side compressor versions.
- Glass door models only...**
- Shelves included.
 - Energy efficient, "Low-E", thermal glass doors.
 - 14-color TruLumina® lighting standard.
- Pass-Thru models only...**
- Designed for convenient front and rear access for serving.



TDR™ DRAFT REFRIGERATION, BLACK EXTERIOR

Model	# of Doors	# of Shelves	HP	Amps	Crated Weight lb. (kg.)	Cabinet Dimensions W D† H* (in)	Cabinet Dimensions W D† H* (mm)
SOLID SWING DOORS & LEFT SIDE REFRIGERATION SYSTEM							
TDR32-RISZ1-L-B-S-1	1	0	½	1.8	240 (109)	32 x 24⅞ x 34¾	813 x 631 x 881
TDR36-RISZ1-L-B-S-1	1	0	½	1.8	270 (123)	36 x 24⅞ x 34¾	914 x 631 x 881
TDR48-RISZ1-L-B-SS-1	2	0	½	1.8	310 (141)	48 x 24⅞ x 34¾	1219 x 631 x 881
TDR52-RISZ1-L-B-SS-1	2	0	½	1.8	320 (146)	52 x 24⅞ x 34¾	1321 x 631 x 881
TDR60-RISZ1-L-B-SS-1	2	0	¼	3.2	330 (150)	60 x 24⅞ x 34¾	1524 x 631 x 881
TDR72-RISZ1-L-B-SSS-1	3	0	¼	3.2	395 (180)	72 x 24⅞ x 34¾	1829 x 631 x 881
TDR84-RISZ1-L-B-SSS-1	3	0	¼	3.2	440 (200)	84 x 24⅞ x 34¾	2134 x 631 x 881
TDR92-RISZ1-L-B-SSSS-1	4	0	¼	3.2	475 (215)	92 x 24⅞ x 34¾	2337 x 631 x 881
TDR108-RISZ1-L-B-SSSS-1	4	0	¼	3.2	535 (243)	108 x 24⅞ x 34¾	2744 x 631 x 881
COMBO SOLID & GLASS SWING DOORS, LEFT SIDE REFRIGERATION SYSTEM							
TDR48-RISZ1-L-B-SG-1	2	3	½	1.8	320 (146)	48 x 24⅞ x 34¾	1219 x 631 x 881
TDR52-RISZ1-L-B-SG-1	2	3	½	1.8	365 (166)	52 x 24⅞ x 34¾	1321 x 631 x 881

† Depth does not include 1½" (39mm) for swing door handles.

* Height does not include 15¾" (400mm) for draft tower.

TDR™ DRAFT REFRIGERATION PASS-THRU, BLACK EXTERIOR

Model	# of Doors	# of Shelves	HP	Amps	Crated Weight lb. (kg.)	Cabinet Dimensions W D† H* (in)	Cabinet Dimensions W D† H* (mm)
SOLID SWING DOORS & LEFT SIDE REFRIGERATION SYSTEM							
TDR36-PTSZ1-L-B-S-S-1	2	0	½	1.8	270 (122)	36 x 24⅞ x 34¾	914 x 631 x 881
TDR60-PTSZ1-L-B-SS-SS-1	4	0	¼	3.2	365 (166)	60 x 24⅞ x 34¾	1524 x 631 x 881
TDR84-PTSZ1-L-B-SSS-SSS-1	6	0	¼	3.2	490 (222)	84 x 24⅞ x 34¾	2134 x 631 x 881

† Depth does not include 1½" (39mm) for swing door handles.

* Height does not include 15¾" (400mm) for draft tower.

Environmentally friendly R290 hydrocarbon refrigeration system for the best in food preservation.



DRAFT REFRIGERATION REACH-IN & PASS-THRU, STAINLESS EXTERIOR *Solid & Glass, Swing Doors*



TDR36-RISZ1-L-S-S-1



TDR52-RISZ1-L-S-SG-1



TDR72-RISZ1-L-S-SSS-1



TDR92-RISZ1-L-S-SSSS-1

Features/Benefits

- Maintains cold 33°F to 38°F (0.5°C to 3.3°C) product temperatures.
 - Exterior - Black, powder coated cold-rolled steel with stainless steel countertop.
 - Interior - stainless steel floor and sides.
 - Insulated and chilled draft columns.
 - Fan motors direct large volume of cold air into draft columns.
 - White LED Interior Lighting for excellent visibility. (optional 14-color TruLumina® on glass and solid door combos)
 - NSF/ANSI Standard 7 compliant for packaged and bottled product.
 - Zero clearance recessed plug and front breathing.
 - 24" (610mm) depth makes for easy placement in tight areas. Conserves valuable work space.
 - Positive seal doors.
 - Each cabinet designed to accommodate a variety of beer kegs. See keg brochure on website for details.
 - Leg levelers standard with 7 other castor/leg options for various heights.
 - Three (3) interior access ports.
 - All TDR models also available in right side compressor versions.
- Glass door models only...**
- Shelves included.
 - Energy efficient, "Low-E", thermal glass doors.
 - 14-color TruLumina® lighting standard.
- Pass-Thru models only...**
- Designed for convenient front and rear access for serving.



TDR™ DRAFT REFRIGERATION REACH-IN, STAINLESS EXTERIOR

Model	# of Doors	# of Shelves	HP	Amps	Crated Weight lb. (kg.)	Cabinet Dimensions W D† H* (in)	Cabinet Dimensions W D† H* (mm)
SOLID SWING DOORS & LEFT SIDE REFRIGERATION SYSTEM							
TDR32-RISZ1-L-S-S-1	1	0	½	1.8	240 (109)	32 x 24 ⁷ / ₈ x 34 ³ / ₄	813 x 631 x 881
TDR36-RISZ1-L-S-S-1	1	0	½	1.8	270 (123)	36 x 24 ⁷ / ₈ x 34 ³ / ₄	914 x 631 x 881
TDR48-RISZ1-L-S-SS-1	2	0	½	1.8	320 (146)	48 x 24 ⁷ / ₈ x 34 ³ / ₄	1219 x 631 x 881
TDR52-RISZ1-L-S-SS-1	2	0	½	1.8	355 (161)	52 x 24 ⁷ / ₈ x 34 ³ / ₄	1321 x 631 x 881
TDR60-RISZ1-L-S-SS-1	2	0	¼	3.2	330 (150)	60 x 24 ⁷ / ₈ x 34 ³ / ₄	1524 x 631 x 881
TDR72-RISZ1-L-S-SSS-1	3	0	¼	3.2	395 (179)	72 x 24 ⁷ / ₈ x 34 ³ / ₄	1829 x 631 x 881
TDR84-RISZ1-L-S-SSS-1	3	0	¼	3.2	440 (200)	84 x 24 ⁷ / ₈ x 34 ³ / ₄	2134 x 631 x 881
TDR92-RISZ1-L-S-SSSS-1	4	0	¼	3.2	475 (215)	92 x 24 ⁷ / ₈ x 34 ³ / ₄	2337 x 631 x 881
TDR108-RISZ1-L-S-SSSS-1	4	0	¼	3.2	535 (243)	108 x 24 ⁷ / ₈ x 34 ³ / ₄	2744 x 631 x 881
COMBO SOLID & GLASS SWING DOORS, LEFT SIDE REFRIGERATION SYSTEM							
TDR48-RISZ1-L-S-SG-1	2	3	½	1.8	330 (150)	48 x 24 ⁷ / ₈ x 34 ³ / ₄	1219 x 631 x 881
TDR52-RISZ1-L-S-SG-1	2	3	½	1.8	365 (166)	52 x 24 ⁷ / ₈ x 34 ³ / ₄	1321 x 631 x 881

† Depth does not include 1½" (39mm) for swing door handles.

* Height does not include 15¾" (400mm) for draft tower.

TDR™ DRAFT REFRIGERATION PASS-THRU, STAINLESS EXTERIOR

Model	# of Doors	# of Shelves	HP	Amps	Crated Weight lb. (kg.)	Cabinet Dimensions W D† H* (in)	Cabinet Dimensions W D† H* (mm)
SOLID SWING DOORS & LEFT SIDE REFRIGERATION SYSTEM							
TDR36-PTSZ1-L-S-S-1	2	0	½	1.8	270 (122)	36 x 24 ⁷ / ₈ x 34 ³ / ₄	914 x 631 x 881
TDR60-PTSZ1-L-S-SS-SS-1	4	0	¼	3.2	365 (166)	60 x 24 ⁷ / ₈ x 34 ³ / ₄	1524 x 631 x 881
TDR84-PTSZ1-L-S-SSS-SSS-1	6	0	¼	3.2	490 (222)	84 x 24 ⁷ / ₈ x 34 ³ / ₄	2134 x 631 x 881

† Depth does not include 1½" (39mm) for swing door handles.

* Height does not include 15¾" (400mm) for draft tower.

Environmentally friendly R290 hydrocarbon refrigeration system for the best in food preservation.



DIRECT DRAW BEER DISPENSERS, BLACK & STAINLESS EXTERIORS

Solid Swing Doors



TDD-1-HC



TDD-3-HC



TDD-3CT-HC



TDD-4-S-HC

Features/Benefits

- Provides ice cold products 33°F to 38°F (0.5°C to 3.3°C) (normal ambient conditions).
- Exterior - Black, powder coated cold-rolled steel with stainless steel countertop.
- Interior - Stainless steel floor with ½" (13mm) lip & heavy galvanized steel walls.
- Insulated and chilled draft columns.
- LED interior lighting.
- NSF/ANSI Standard 7 compliant for open food product.
- Air vents on side to maximize flow of fresh air through condenser.
- Positive seal doors.
- Self-contained system.
- Each cabinet designed to accommodate a variety of beer kegs. See keg brochure on website for details.

- Available with optional legs or 2½" (64mm) or 4" (102mm) diameter castors (TDD-1-HC/1-S-HC: 4" (102mm) diameter castors standard equipment; 2½" (64mm) diameter castors & legs not available).

Club-Top models have...

- One, 3/8" (10mm) easy to reach, heavy-duty, black PVC-coated wire refrigerated storage shelf for chilled beer or wine glasses.
- Anodized aluminum glass rail provides convenient storage area for glasses on top.
- Convenient easy-glide lid.
- Flip-lock to secure stainless steel lid.

Stainless Steel models have...

- Stainless steel exterior and countertop for those who appreciate the value of stainless.



TDD™ DIRECT DRAW BEER DISPENSERS, STAINLESS TOP, BLACK EXTERIOR

Model	# of Doors	HP	Amps	Crated Weight lb. (kg.)	Cabinet Dimensions W D† H* (in)	Cabinet Dimensions W D† H* (mm)
SOLID SWING DOORS						
TDD-1-HC	1	1/10	1.4	205 (93)	23½ x 31¼ x 39¾	597 x 794 x 1010
TDD-2-HC	2	¼	2.8	330 (150)	58⅞ x 27⅞ x 37	1496 x 689 x 940
TDD-3-HC	2	¼	2.8	365 (166)	69⅞ x 27⅞ x 37	1756 x 689 x 940
TDD-4-HC	3	¼	2.8	445 (225)	90⅝ x 27⅞ x 37	2296 x 689 x 940

† Depth does not include 1" (26mm) for rear bumpers (excludes TDD-1-HC).

* Height does not include 15¼" (388mm) for draft arm.

TDD™ DIRECT DRAW BEER DISPENSERS, STAINLESS EXTERIOR

Model	# of Doors	HP	Amps	Crated Weight lb. (kg.)	Cabinet Dimensions W D† H* (in)	Cabinet Dimensions W D† H* (mm)
SOLID SWING DOORS						
TDD-1-S-HC	1	1/10	1.4	215 (98)	23½ x 31¼ x 39¾	597 x 794 x 1010
TDD-2-S-HC	2	¼	2.8	330 (150)	58⅞ x 27⅞ x 37	1496 x 689 x 940
TDD-3-S-HC	2	¼	2.8	360 (164)	69⅞ x 27⅞ x 37	1756 x 689 x 940
TDD-4-S-HC	3	¼	2.8	405 (184)	90⅝ x 27⅞ x 37	2296 x 689 x 940

† Depth does not include 1" (26mm) for rear bumpers (excludes TDD-1-S-HC).

* Height does not include 15¼" (388mm) for draft arm.

TDD™ CLUB-TOP DIRECT DRAW BEER DISPENSERS, STAINLESS TOP, BLACK EXTERIOR

Model	# of Doors	HP	Amps	Crated Weight lb. (kg.)	Cabinet Dimensions W D† H* (in)	Cabinet Dimensions W D† H* (mm)
SOLID SWING DOORS						
TDD-2CT-HC	2	¼	2.8	350 (159)	58⅞ x 27⅞ x 38½	1496 x 689 x 940
TDD-3CT-HC	2	¼	2.8	385 (175)	69⅞ x 27⅞ x 38½	1756 x 689 x 940
TDD-4CT-HC	3	¼	2.8	465 (211)	90⅝ x 27⅞ x 38½	2296 x 689 x 940

† Depth does not include 1" (26mm) for rear bumpers.

* Height does not include 13¾" (350mm) for draft arm.

TDD™ CLUB-TOP DIRECT DRAW BEER DISPENSERS, STAINLESS TOP, STAINLESS EXTERIOR

Model	# of Doors	HP	Amps	Crated Weight lb. (kg.)	Cabinet Dimensions W D† H* (in)	Cabinet Dimensions W D† H* (mm)
SOLID SWING DOORS						
TDD-2CT-S-HC	2	¼	2.8	350 (159)	58⅞ x 27⅞ x 38½	1496 x 689 x 940
TDD-3CT-S-HC	2	¼	2.8	385 (175)	69⅞ x 27⅞ x 38½	1756 x 689 x 940
TDD-4CT-S-HC	3	¼	2.8	485 (220)	90⅝ x 27⅞ x 38½	2296 x 689 x 940

† Depth does not include 1" (26mm) for rear bumpers.

* Height does not include 13¾" (350mm) for draft arm.

TDD™ NITRO KIT MODELS

Sold Separately. See "accessories" section for additional individual nomenclature.

Environmentally friendly R290 hydrocarbon refrigeration system for the best in food preservation.



HORIZONTAL BOTTLE COOLERS - DEEP WELL & GLASS & PLATE CHILLERS/FROSTERS

Solid Slide Lids

Heavy-duty 3/8" (10mm) thick pure grade PVC-coated adjustable bin dividers for maximum storage use



Heavy-duty PVC-coated wire shelves for maximum flexibility



Huge capacity requires minimum floor space



Largest storage capacity in the industry - meets supply and demand requirements during peak hours

TD-36-12-HC

T-36-GC-S-HC



TD-24-7-HC



TD-50-18-S-HC



TD-80-30-HC



T-36-GC-HC



T-50-GC-S-HC

Features/Benefits

Horizontal Bottle Coolers - Deep Well

- Provides ice cold products 33°F to 38°F (0.5°C to 3.3°C) – very fast pull-down capacity.
- Positive guided, forced air cooling - cools bottles on top first.
- Exterior - Black, powder coated cold-rolled steel with stainless steel countertop and lids.
- Interior - long lasting heavy-duty galvanized steel. Complies with NSF/ANSI Standard 7 for packaged and bottled product.
- LED interior lighting.
- Huge capacity requires minimum floor space.
- Rugged, removable, bottle cap opener and cap catcher included. Field installed.
- Self-contained system.
- Available with optional 6" (153mm) legs or 3" (77mm) or 2½" (64mm) diameter castors.

Glass & Plate Chillers/Frosters

- Save time - load glasses dry and frost even faster with temperature 0°F (-17.8°C) and below.
 - Exterior - Black, powder coated cold-rolled steel with stainless steel countertop and lids.
 - Interior - long lasting heavy-duty galvanized steel.
 - Listed under NSF/ANSI standard 7 for the storage and/or display of packaged or bottled product..
 - Automatic defrost system time-initiated, time-terminated.
 - Self-contained system.
 - Available with optional legs or 3" (77mm) or 2½" (64mm) diameter castors.
 - Available with optional ratchet locks for added security.
- Stainless Steel models have...**
- Stainless steel exterior and countertop for those who appreciate the value of stainless.



TD™ HORIZONTAL BOTTLE COOLERS - DEEP WELL

Model	# of Lids	# of Dividers	HP	Amps	Crated Weight lb. (kg.)	Cabinet Dimensions W D† H* (in)	Cabinet Dimensions W D† H* (mm)
BLACK EXTERIOR							
TD-24-7-HC	1	2	1/10	1.4	180 (82)	24½ x 26⅞ x 33½	623 x 683 x 850
TD-36-12-HC	1	2	1/10	1.4	230 (105)	36⅞ x 26⅞ x 33½	931 x 683 x 850
TD-50-18-HC	2	3	1/5	1.9	280 (128)	49½ x 26⅞ x 33½	1255 x 683 x 850
TD-65-24-HC	2	4	1/5	1.9	370 (168)	64½ x 26⅞ x 33½	1636 x 683 x 850
TD-80-30-HC	3	6	1/4	2.8	415 (188)	80⅞ x 26⅞ x 33½	2035 x 683 x 850
TD-95-38-HC	3	7	1/4	3.1	480 (218)	95⅞ x 26⅞ x 33½	2416 x 683 x 850
STAINLESS EXTERIOR							
TD-24-7-S-HC	1	2	1/10	1.4	180 (82)	24½ x 26⅞ x 33½	623 x 683 x 850
TD-36-12-S-HC	1	2	1/10	1.4	225 (103)	36⅞ x 26⅞ x 33⅜	934 x 677 x 848
TD-50-18-S-HC	2	3	1/5	1.9	280 (128)	49⅞ x 26⅞ x 33⅜	1261 x 677 x 848
TD-65-24-S-HC	2	4	1/5	1.9	370 (168)	64⅞ x 26⅞ x 33⅜	1642 x 677 x 848
TD-80-30-S-HC	3	6	1/4	2.8	415 (189)	80⅞ x 26⅞ x 33½	2035 x 683 x 850
TD-95-38-S-HC	3	7	1/4	3.1	470 (214)	95⅞ x 26⅞ x 33⅜	2423 x 677 x 848

† Depth does not include 1½" (39mm) for cap catcher or 1" (26mm) for rear bumpers.
 note: 12 oz. bottles refers to 12 oz. longneck bottles.

T-GC™ GLASS & PLATE CHILLERS/FROSTERS

Model	# of Lids	# of Dividers	HP	Amps	Crated Weight lb. (kg.)	Cabinet Dimensions W D† H* (in)	Cabinet Dimensions W D† H* (mm)
BLACK EXTERIOR							
T-24-GC-HC	1	3	1/5	2.3	180 (82)	24½ x 26⅞ x 33½	623 x 683 x 850
T-36-GC-HC	1	3	1/4	2.3	240 (109)	36¾ x 26⅞ x 33⅜	934 x 677 x 848
T-50-GC-HC	2	5	1/3	3.5	290 (132)	49⅞ x 26⅞ x 33⅜	1261 x 677 x 848
STAINLESS EXTERIOR							
T-24-GC-S-HC	1	3	1/5	2.3	185 (84)	24½ x 26⅞ x 33½	623 x 683 x 850
T-36-GC-S-HC	1	3	1/4	2.3	245 (112)	36¾ x 26⅞ x 33⅜	934 x 677 x 848
T-50-GC-S-HC	2	5	1/3	3.5	290 (132)	49⅞ x 26⅞ x 33⅜	1261 x 677 x 848

† Depth does not include 1" (26mm) for rear bumpers.

T-GC™ GLASS LID OPTIONS

Model
GLASS LIDS "GLID"
TD-24-7-HC
TD-36-12-HC
TD-50-18-HC
TD-65-24-HC
TD-80-30-HC
TD-95-38-HC

Environmentally friendly R290 hydrocarbon refrigeration system for the best in food preservation.



BAR REFRIGERATION CAN/BOTTLE/BARREL CAPACITY

Model	Capacity (12oz. Cans)	Capacity (12oz. Bottles)	Capacity (Barrels)
TBR - REACH-IN, BLACK EXTERIOR			
TBR32-RISZ1-L-B-S-1	38 - 6pk.12oz.	21 - 6pk.12oz.	2 - 1/6
TBR36-RISZ1-L-B-S-1	44 - 6pk.12oz.	27 - 6pk.12oz.	4 - 1/6
TBR48-RISZ1-L-B-SS-1	76 - 6pk.12oz.	43 - 6pk.12oz.	6 - 1/6
TBR52-RISZ1-L-B-SS-1	78 - 6pk.12oz.	49 - 6pk.12oz.	2 - 1/2
TBR60-RISZ1-L-B-SS-1	101 - 6pk.12oz.	63 - 6pk.12oz.	2 - 1/2
TBR72-RISZ1-L-B-SSS-1	125 - 6pk.12oz.	78 - 6pk.12oz.	3 - 1/2
TBR84-RISZ1-L-B-SSS-1	164 - 6pk.12oz.	96 - 6pk.12oz.	3 - 1/2
TBR92-RISZ1-L-B-SSSS-1	182 - 6pk.12oz.	108 - 6pk.12oz.	4 - 1/2
TBR108-RISZ1-L-B-SSSS-1	220 - 6pk.12oz.	132 - 6pk.12oz.	4 - 1/2
TBR32-RISZ1-L-B-G-1	38 - 6pk.12oz.	21 - 6pk.12oz.	2 - 1/6
TBR36-RISZ1-L-B-G-1	44 - 6pk.12oz.	27 - 6pk.12oz.	4 - 1/6
TBR48-RISZ1-L-B-GG-1	76 - 6pk.12oz.	43 - 6pk.12oz.	6 - 1/6
TBR52-RISZ1-L-B-GG-1	78 - 6pk.12oz.	49 - 6pk.12oz.	2 - 1/2
TBR60-RISZ1-L-B-GG-1	101 - 6pk.12oz.	63 - 6pk.12oz.	2 - 1/2
TBR72-RISZ1-L-B-GGG-1	125 - 6pk.12oz.	78 - 6pk.12oz.	3 - 1/2
TBR84-RISZ1-L-B-GGG-1	164 - 6pk.12oz.	96 - 6pk.12oz.	3 - 1/2
TBR92-RISZ1-L-B-GGGG-1	182 - 6pk.12oz.	108 - 6pk.12oz.	4 - 1/2
TBR108-RISZ1-L-B-GGGG-1	220 - 6pk.12oz.	132 - 6pk.12oz.	4 - 1/2
TBR48-RISZ1-L-B-11-1	68 - 6pk.12oz.	43 - 6pk.12oz.	5 - 1/6
TBR52-RISZ1-L-B-11-1	78 - 6pk.12oz.	48 - 6pk.12oz.	2 - 1/2
TBR60-RISZ1-L-B-11-1	100 - 6pk.12oz.	59 - 6pk.12oz.	2 - 1/2
TBR72-RISZ1-L-B-111-1	120 - 6pk.12oz.	73 - 6pk.12oz.	3 - 1/2
TBR - PASS-THRU, BLACK EXTERIOR			
TBR36-PTSZ1-L-B-S-S-1	38 - 6pk.12oz.	25 - 6pk.12oz.	6 - 1/6
TBR60-PTSZ1-L-B-SS-SS-1	89 - 6pk.12oz.	57 - 6pk.12oz.	2 - 1/2
TBR84-PTSZ1-L-B-SSS-SSS-1	164 - 6pk.12oz.	88 - 6pk.12oz.	3 - 1/2
TBR36-PTSZ1-L-B-G-G-1	38 - 6pk.12oz.	25 - 6pk.12oz.	6 - 1/6
TBR60-PTSZ1-L-B-GG-GG-1	89 - 6pk.12oz.	57 - 6pk.12oz.	2 - 1/2
TBR84-PTSZ1-L-B-GGG-GGG-1	164 - 6pk.12oz.	88 - 6pk.12oz.	3 - 1/2
TBR60-PTSZ1-L-B-11-11-1	88 - 6pk.12oz.	54 - 6pk.12oz.	2 - 1/2
TBR - REACH-IN, STAINLESS EXTERIOR			
TBR32-RISZ1-L-S-S-1	38 - 6pk.12oz.	21 - 6pk.12oz.	2 - 1/6
TBR36-RISZ1-L-S-S-1	44 - 6pk.12oz.	27 - 6pk.12oz.	4 - 1/6
TBR48-RISZ1-L-S-SS-1	76 - 6pk.12oz.	43 - 6pk.12oz.	6 - 1/6
TBR52-RISZ1-L-S-SS-1	78 - 6pk.12oz.	49 - 6pk.12oz.	2 - 1/2
TBR60-RISZ1-L-S-SS-1	101 - 6pk.12oz.	63 - 6pk.12oz.	2 - 1/2
TBR72-RISZ1-L-S-SSS-1	125 - 6pk.12oz.	78 - 6pk.12oz.	3 - 1/2
TBR84-RISZ1-L-S-SSS-1	164 - 6pk.12oz.	96 - 6pk.12oz.	3 - 1/2
TBR92-RISZ1-L-S-SSSS-1	182 - 6pk.12oz.	108 - 6pk.12oz.	4 - 1/2
TBR108-RISZ1-L-S-SSSS-1	220 - 6pk.12oz.	132 - 6pk.12oz.	4 - 1/2
TBR32-RISZ1-L-S-G-1	38 - 6pk.12oz.	21 - 6pk.12oz.	2 - 1/6
TBR36-RISZ1-L-S-G-1	44 - 6pk.12oz.	27 - 6pk.12oz.	4 - 1/6
TBR48-RISZ1-L-S-GG-1	76 - 6pk.12oz.	43 - 6pk.12oz.	6 - 1/6
TBR52-RISZ1-L-S-GG-1	78 - 6pk.12oz.	49 - 6pk.12oz.	2 - 1/2
TBR60-RISZ1-L-S-GG-1	101 - 6pk.12oz.	63 - 6pk.12oz.	2 - 1/2
TBR72-RISZ1-L-S-GGG-1	125 - 6pk.12oz.	78 - 6pk.12oz.	3 - 1/2
TBR84-RISZ1-L-S-GGG-1	164 - 6pk.12oz.	96 - 6pk.12oz.	3 - 1/2
TBR92-RISZ1-L-S-GGGG-1	182 - 6pk.12oz.	108 - 6pk.12oz.	4 - 1/2
TBR108-RISZ1-L-S-GGGG-1	220 - 6pk.12oz.	132 - 6pk.12oz.	4 - 1/2

note: 12 oz. bottles refers to 12 oz. longneck bottles.

Model	Capacity (12oz. Cans)	Capacity (12oz. Bottles)	Capacity (Barrels)
TBR - REACH-IN, STAINLESS EXTERIOR (CONT.)			
TBR48-RISZ1-L-S-11-1	68 - 6pk.12oz.	43 - 6pk.12oz.	5 - 1/6
TBR52-RISZ1-L-S-11-1	78 - 6pk.12oz.	48 - 6pk.12oz.	2 - 1/2
TBR60-RISZ1-L-S-11-1	100 - 6pk.12oz.	59 - 6pk.12oz.	2 - 1/2
TBR72-RISZ1-L-S-111-1	120 - 6pk.12oz.	73 - 6pk.12oz.	3 - 1/2
TBR - PASS THRU, STAINLESS EXTERIOR			
TBR36-PTSZ1-L-S-S-S-1	38 - 6pk.12oz.	25 - 6pk.12oz.	6 - 1/6
TBR60-PTSZ1-L-S-SS-SS-1	89 - 6pk.12oz.	57 - 6pk.12oz.	2 - 1/2
TBR84-PTSZ1-L-S-SSS-SSS-1	164 - 6pk.12oz.	88 - 6pk.12oz.	3 - 1/2
TBR36-PTSZ1-L-S-G-G-1	38 - 6pk.12oz.	25 - 6pk.12oz.	6 - 1/6
TBR60-PTSZ1-L-S-GG-GG-1	89 - 6pk.12oz.	57 - 6pk.12oz.	2 - 1/2
TBR84-PTSZ1-L-S-GGG-GGG-1	164 - 6pk.12oz.	88 - 6pk.12oz.	3 - 1/2
TBR60-PTSZ1-L-S-11-11-1	88 - 6pk.12oz.	54 - 6pk.12oz.	2 - 1/2
TDR - REACH-IN, BLACK EXTERIOR			
TDR32-RISZ1-L-B-S-1	38 - 6pk.12oz.	21 - 6pk.12oz.	2 - 1/6
TDR36-RISZ1-L-B-S-1	44 - 6pk.12oz.	27 - 6pk.12oz.	4 - 1/6
TDR48-RISZ1-L-B-SS-1	76 - 6pk.12oz.	43 - 6pk.12oz.	6 - 1/6
TDR52-RISZ1-L-B-SS-1	78 - 6pk.12oz.	49 - 6pk.12oz.	2 - 1/2
TDR60-RISZ1-L-B-SS-1	101 - 6pk.12oz.	63 - 6pk.12oz.	2 - 1/2
TDR72-RISZ1-L-B-SSS-1	125 - 6pk.12oz.	78 - 6pk.12oz.	2 - 1/2
TDR84-RISZ1-L-B-SSS-1	164 - 6pk.12oz.	96 - 6pk.12oz.	2 - 1/2
TDR92-RISZ1-L-B-SSSS-1	182 - 6pk.12oz.	108 - 6pk.12oz.	2 - 1/2
TDR108-RISZ1-L-B-SSSS-1	220 - 6pk.12oz.	132 - 6pk.12oz.	2 - 1/2
TDR48-RISZ1-L-B-SG-1	38 - 6pk.12oz.	21 - 6pk.12oz.	3 - 1/6
TDR52-RISZ1-L-B-SG-1	38 - 6pk.12oz.	24 - 6pk.12oz.	2 - 1/2
TDR - PASS-THRU, BLACK EXTERIOR			
TDR36-PTSZ1-L-B-S-S-1	38 - 6pk.12oz.	25 - 6pk.12oz.	6 - 1/6
TDR60-PTSZ1-L-B-SS-SS-1	89 - 6pk.12oz.	57 - 6pk.12oz.	2 - 1/2
TDR84-PTSZ1-L-B-SSS-SSS-1	164 - 6pk.12oz.	88 - 6pk.12oz.	6 - 1/2
TDR - REACH-IN, STAINLESS EXTERIOR			
TDR32-RISZ1-L-S-S-1	38 - 6pk.12oz.	21 - 6pk.12oz.	2 - 1/6
TDR36-RISZ1-L-S-S-1	44 - 6pk.12oz.	27 - 6pk.12oz.	4 - 1/6
TDR48-RISZ1-L-S-SS-1	76 - 6pk.12oz.	43 - 6pk.12oz.	6 - 1/6
TDR52-RISZ1-L-S-SS-1	78 - 6pk.12oz.	49 - 6pk.12oz.	2 - 1/2
TDR60-RISZ1-L-S-SS-1	101 - 6pk.12oz.	63 - 6pk.12oz.	2 - 1/2
TDR72-RISZ1-L-S-SSS-1	125 - 6pk.12oz.	78 - 6pk.12oz.	2 - 1/2
TDR84-RISZ1-L-S-SSS-1	164 - 6pk.12oz.	96 - 6pk.12oz.	2 - 1/2
TDR92-RISZ1-L-S-SSSS-1	182 - 6pk.12oz.	108 - 6pk.12oz.	2 - 1/2
TDR108-RISZ1-L-S-SSSS-1	220 - 6pk.12oz.	132 - 6pk.12oz.	2 - 1/2
TDR48-RISZ1-L-S-SG-1	38 - 6pk.12oz.	21 - 6pk.12oz.	3 - 1/6
TDR52-RISZ1-L-S-SG-1	38 - 6pk.12oz.	24 - 6pk.12oz.	2 - 1/2
TDR - PASS-THRU, STAINLESS EXTERIOR			
TDR36-PTSZ1-L-S-S-S-1	38 - 6pk.12oz.	25 - 6pk.12oz.	6 - 1/6
TDR60-PTSZ1-L-S-SS-SS-1	89 - 6pk.12oz.	57 - 6pk.12oz.	2 - 1/2
TDR84-PTSZ1-L-S-SSS-SSS-1	164 - 6pk.12oz.	88 - 6pk.12oz.	6 - 1/2
TBB - REACH-IN, STAINLESS TOP, BLACK EXTERIOR			
TBB-1-HC	30 6-pks12oz.	-	1 - 1/2
TBB-2-HC	88 6-pks12oz.	-	2 - 1/2
TBB-3-HC	112 6-pks12oz.	-	3 - 1/2
TBB-4-HC	152 6-pks12oz.	-	4 - 1/2

note: 12 oz. bottles refers to 12 oz. longneck bottles.

Model	Capacity (12oz. Cans)	Capacity (12oz. Bottles)	Capacity (Barrels)
TBB - REACH-IN, STAINLESS TOP, BLACK EXTERIOR			
TBB-2G-HC-LD	88 6-pks.12oz.	-	2 - 1/2
TBB-3G-HC-LD	112 6-pks.12oz.	-	3 - 1/2
TBB-4G-HC-LD	152 6-pks.12oz.	-	4 - 1/2
TBB - PASS-THRU, STAINLESS TOP, BLACK EXTERIOR			
TBB-4PT	152 6-pks.12oz.	-	4 - 1/2
TBB - REACH-IN, STAINLESS TOP, STAINLESS EXTERIOR			
TBB-1-S-HC	30 6-pks.12oz.	-	1 - 1/2
TBB-2-S-HC	88 6-pks.12oz.	-	2 - 1/2
TBB-3-S-HC	112 6-pks.12oz.	-	3 - 1/2
TBB-4-S-HC	152 6-pks.12oz.	-	4 - 1/2
TBB-2G-S-HC-LD	88 6-pks.12oz.	-	2 - 1/2
TBB-3G-S-HC-LD	112 6-pks.12oz.	-	3 - 1/2
TBB-4G-S-HC-LD	152 6-pks.12oz.	-	4 - 1/2
TBB - PASS-THRU, STAINLESS TOP, STAINLESS EXTERIOR			
TBB-4PT-S	152 6-pks.12oz.	-	4 - 1/2
TBB24 - 24" (610MM) REACH-IN, STAINLESS TOP, STAINLESS EXTERIOR			
TBB24-48-2S-Z1-SFT-B-1	76 6-pks.12oz.	43 6-pks.12oz.	6 - 1/6
TBB24-60-2S-Z1-SFT-B-1	89 6-pks.12oz.	57 6-pks.12oz.	2 - 1/2
TBB24-72-3S-Z1-SFT-B-1	125 6-pks.12oz.	78 6-pks.12oz.	3 - 1/2
TBB24-48-2G-Z1-SFT-B-1	76 6-pks.12oz.	43 6-pks.12oz.	6 - 1/6
TBB24-60-2G-Z1-SFT-B-1	89 6-pks.12oz.	57 6-pks.12oz.	2 - 1/2
TBB24-72-3G-Z1-SFT-B-1	125 6-pks.12oz.	78 6-pks.12oz.	3 - 1/2
TBB24 - 24" (610MM) REACH-IN, STAINLESS TOP, STAINLESS EXTERIOR			
TBB24-48-2S-Z1-SFT-S-1	76 6-pks.12oz.	43 6-pks.12oz.	6 - 1/6
TBB24-60-2S-Z1-SFT-S-1	89 6-pks.12oz.	57 6-pks.12oz.	2 - 1/2
TBB24-72-3S-Z1-SFT-S-1	125 6-pks.12oz.	78 6-pks.12oz.	3 - 1/2
TBB24-48-2G-Z1-SFT-S-1	76 6-pks.12oz.	43 6-pks.12oz.	6 - 1/6
TBB24-60-2G-Z1-SFT-S-1	89 6-pks.12oz.	57 6-pks.12oz.	2 - 1/2
TBB24-72-3G-Z1-SFT-S-1	125 6-pks.12oz.	78 6-pks.12oz.	3 - 1/2
TBB24 - 24" (610MM) REACH-IN, BLACK SUB-TOP, BLACK EXTERIOR			
TBB24-48-2S-Z1-BST-B-1	76 6-pks.12oz.	43 6-pks.12oz.	6 - 1/6
TBB24-60-2S-Z1-BST-B-1	89 6-pks.12oz.	57 6-pks.12oz.	2 - 1/2
TBB24-72-3S-Z1-BST-B-1	125 6-pks.12oz.	78 6-pks.12oz.	3 - 1/2
TBB24-48-2G-Z1-BST-B-1	76 6-pks.12oz.	43 6-pks.12oz.	6 - 1/6
TBB24-60-2G-Z1-BST-B-1	89 6-pks.12oz.	57 6-pks.12oz.	2 - 1/2
TBB24-72-3G-Z1-BST-B-1	125 6-pks.12oz.	78 6-pks.12oz.	3 - 1/2
TBB24 - 24" (610MM) REACH-IN, BLACK SUB-TOP, STAINLESS EXTERIOR			
TBB24-48-2S-Z1-BST-S-1	76 6-pks.12oz.	43 6-pks.12oz.	6 - 1/6
TBB24-60-2S-Z1-BST-S-1	89 6-pks.12oz.	57 6-pks.12oz.	2 - 1/2
TBB24-72-3S-Z1-BST-S-1	125 6-pks.12oz.	78 6-pks.12oz.	3 - 1/2
TBB24-48-2G-Z1-BST-S-1	76 6-pks.12oz.	43 6-pks.12oz.	6 - 1/6
TBB24-60-2G-Z1-BST-S-1	89 6-pks.12oz.	57 6-pks.12oz.	2 - 1/2
TBB24-72-3G-Z1-BST-S-1	125 6-pks.12oz.	78 6-pks.12oz.	3 - 1/2
TDD - STAINLESS TOP, BLACK EXTERIOR			
TDD-1-HC	-	-	1 - 1/2
TDD-2-HC	-	-	2 - 1/2
TDD-3-HC	-	-	3 - 1/2
TDD-4-HC	-	-	4 - 1/2

note: 12 oz. bottles refers to 12 oz. longneck bottles.

Model	Capacity (12oz. Cans)	Capacity (12oz. Bottles)	Capacity (Barrels)
TDD - STAINLESS EXTERIOR			
TDD-1-S-HC	-	-	1 - 1/2
TDD-2-S-HC	-	-	2 - 1/2
TDD-3-S-HC	-	-	3 - 1/2
TDD-4-S-HC	-	-	4 - 1/2
TDD - CLUB-TOP, STAINLESS TOP, BLACK EXTERIOR			
TDD-2CT-HC	-	-	2 - 1/2
TDD-3CT-HC	-	-	3 - 1/2
TDD-4CT-HC	-	-	4 - 1/2
TDD - CLUB-TOP, STAINLESS TOP, STAINLESS EXTERIOR			
TDD-2CT-S-HC	-	-	2 - 1/2
TDD-3CT-S-HC	-	-	3 - 1/2
TDD-4CT-S-HC	-	-	4 - 1/2
TD - HORIZONTAL BOTTLE COOLER - DEEP WELL			
TD-24-7-HC	6 Cases	4.5 Cases	-
TD-36-12-HC	14.5 Cases	11 Cases	-
TD-50-18-HC	24 Cases	16.5 Cases	-
TD-65-24-HC	32.5 Cases	22 Cases	-
TD-80-30-HC	42 Cases	30 Cases	-
TD-95-38-HC	55 Cases	37.5 Cases	-
TD-24-7-S-HC	6 Cases	4.5 Cases	-
TD-36-12-S-HC	14.5 Cases	11 Cases	-
TD-50-18-S-HC	24 Cases	16.5 Cases	-
TD-65-24-S-HC	32.5 Cases	22 Cases	-
TD-80-30-S-HC	42 Cases	30 Cases	-
TD-95-38-S-HC	55 Cases	37.5 Cases	-
T-GC - GLASS & PLATE CHILLERS/FROSTERS			
T-24-GC-HC	85	90	-
T-36-GC-HC	172	180	-
T-50-GC-HC	240	250	-
T-24-GC-S-HC	85	90	-
T-36-GC-S-HC	172	180	-
T-50-GC-S-HC	240	250	-

note: 12 oz. bottles refers to 12 oz. longneck bottles.



Bar Refrigeration | Keg Configurations

TBB®/TDD™ KEG CONFIGURATIONS

Common Draft Beer Keg Footprints

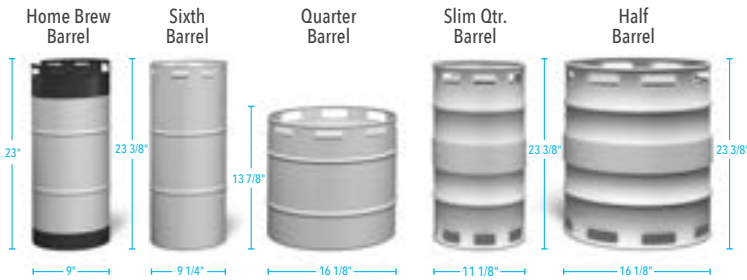

*Above dimensions may vary slightly as a result of differences between keg manufacturers.

DRAFT BEER KEG SPECIFICATIONS*

Size	Home Brew Barrel	Sixth Barrel	Quarter Barrel	Slim Quarter Barrel	Half Barrel
Gallons	5.00	5.16	7.75	7.75	15.50
Ounces	640	611	992	992	1984
# of 12 oz. Beers	53	55	82	82	165
Weight (Full)	49 lbs.	58 lbs.	87 lbs.	87 lbs.	161 lbs.

TBB/TDD-1*

19-3/4" interior width X 24-9/32" interior depth

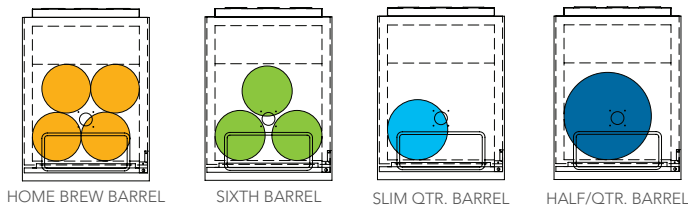

TBB/TDD-2*

43" interior width X 22" interior depth

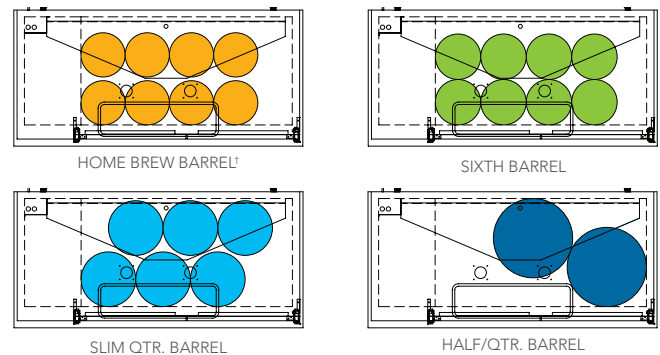

TBB/TDD-3*

53-1/4" interior width X 22" interior depth

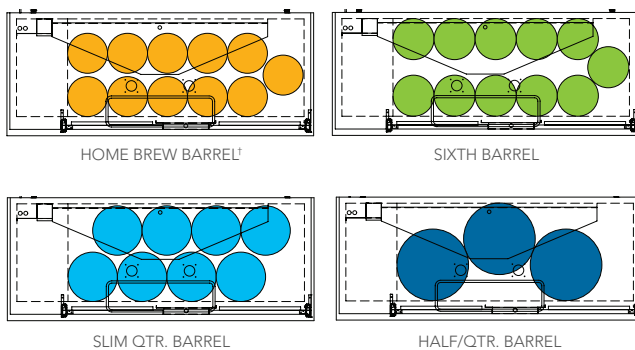

TBB/TDD-4*

72-1/4" interior width X 22" interior depth

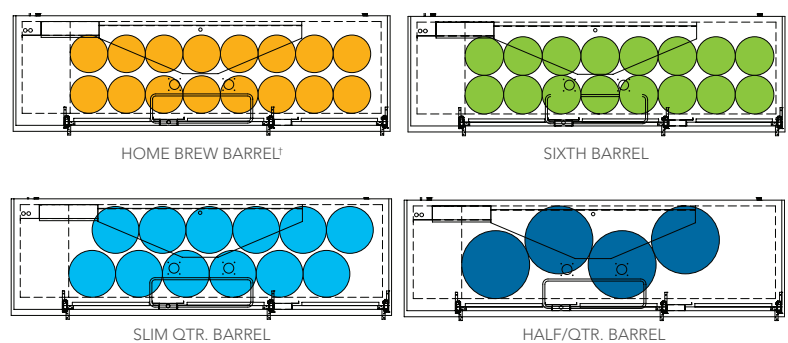

● Half/Quarter Barrel ● Slim Quarter Barrel ● Sixth Barrel ● Home Brew Barrel

* Top view shown. Please consult your beer distributor for specific sizes.
†25-25/32" usable interior height.



TBB[®]24 KEG CONFIGURATIONS

Common Draft Beer Keg Footprints

TBB24-48*

36-5/16" interior width X 18-3/4" interior depth

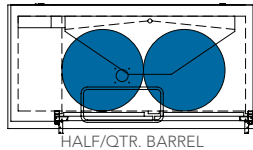
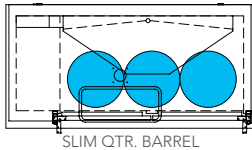
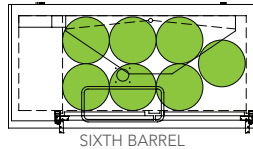
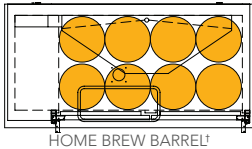

TBB24-60*

48-5/16" interior width X 18-3/4" interior depth

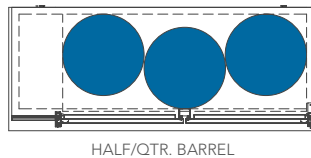
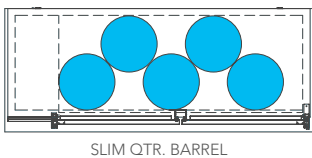
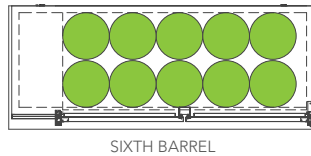
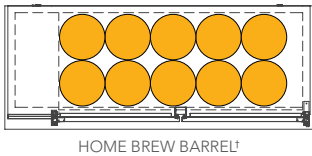

TBB24-72*

60-5/16" interior width X 18-3/4" interior depth

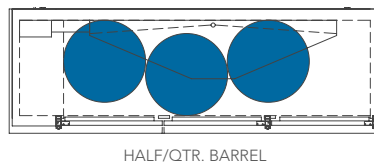
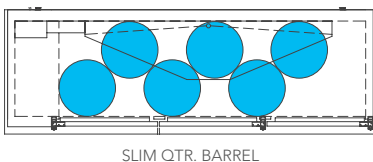
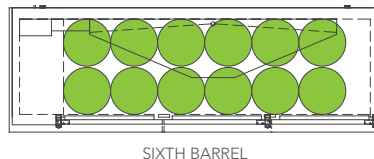
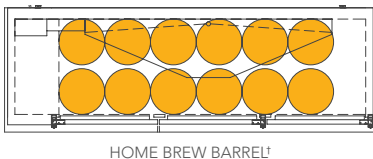

● Half/Quarter Barrel ● Slim Quarter Barrel ● Sixth Barrel ● Home Brew Barrel

* Top view shown. Please consult your beer distributor for specific sizes.
† 25-25/32" usable interior height.



Bar Refrigeration | Keg Configurations

TBR™/TDR™ KEG CONFIGURATIONS

Common Draft Beer Keg Footprints

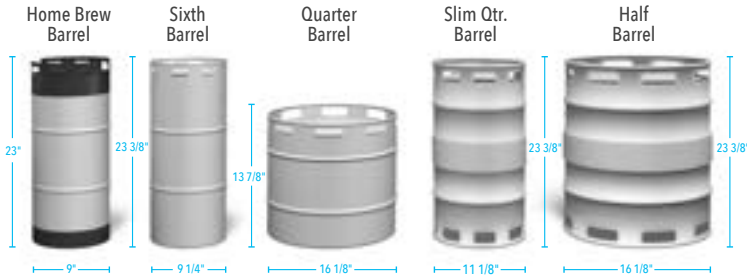

DRAFT BEER KEG SPECIFICATIONS*

Size	Home Brew Barrel	Sixth Barrel	Quarter Barrel	Slim Quarter Barrel	Half Barrel
Gallons	5.00	5.16	7.75	7.75	15.50
Ounces	640	611	992	992	1984
# of 12 oz. Beers	53	55	82	82	165
Weight (Full)	49 lbs.	58 lbs.	87 lbs.	87 lbs.	161 lbs.

*Above dimensions may vary slightly as a result of differences between keg manufacturers.

TBR/TDR-32*

16-13/32" interior width X 18-3/4" interior depth

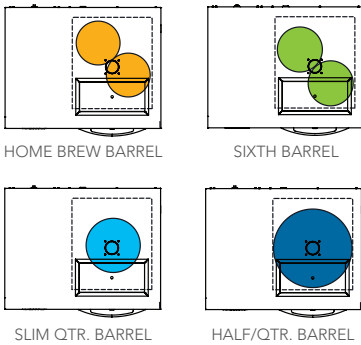

TBR/TDR-36*

20-13/32" interior width X 18-3/4" interior depth

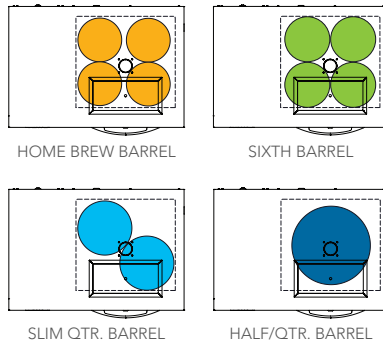

TBR/TDR-48*

32-13/32" interior width X 18-3/4" interior depth

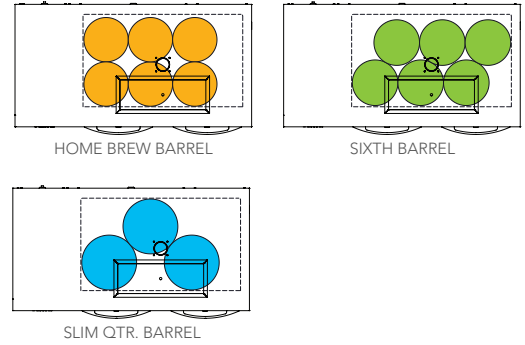

TBR/TDR-52*

36-13/32" interior width X 18-3/4" interior depth

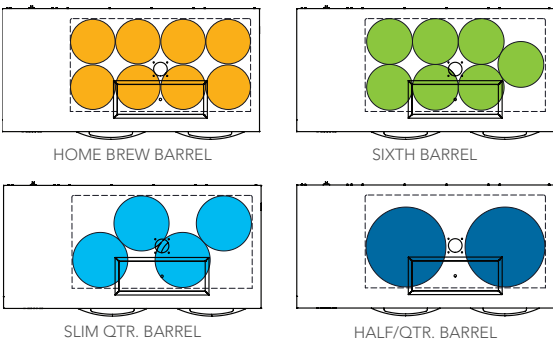

TBR/TDR-60*

44-13/32" interior width X 18-3/4" interior depth

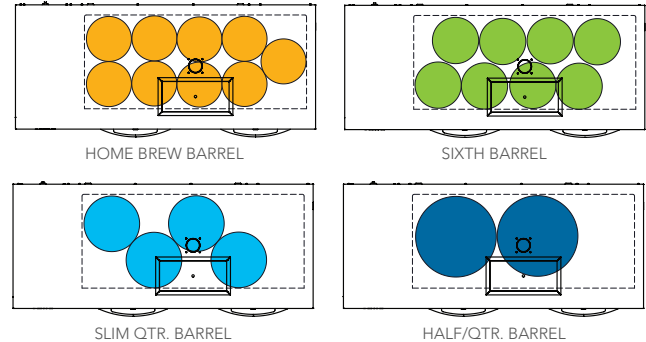

● Half/Quarter Barrel ● Slim Quarter Barrel ● Sixth Barrel ● Home Brew Barrel

* Top view shown. Please consult your beer distributor for specific sizes.
†25-25/32" usable interior height.



TBR/TDR-72*

56-13/32" interior width X 18-3/4" interior depth

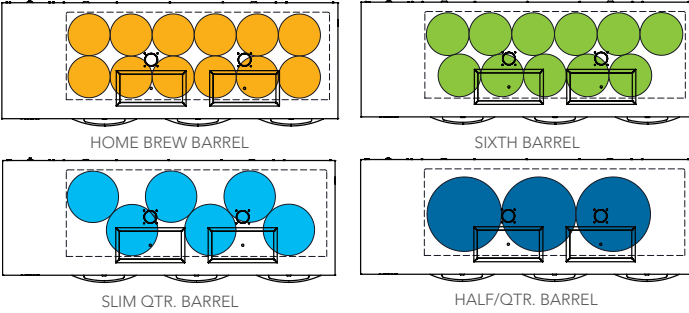

TBR/TDR-84*

68-13/32" interior width X 18-3/4" interior depth

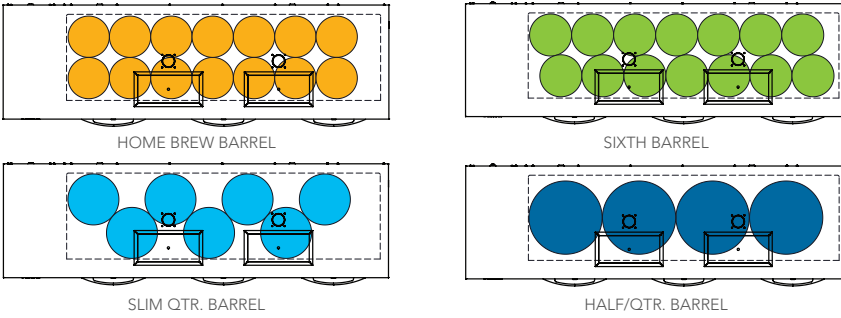

TBR/TDR-92*

76-13/32" interior width X 18-3/4" interior depth

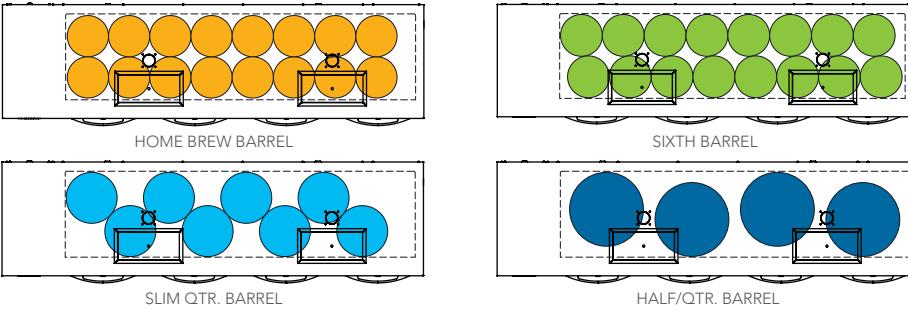

TBR/TDR-108*

92-13/32" interior width X 18-3/4" interior depth

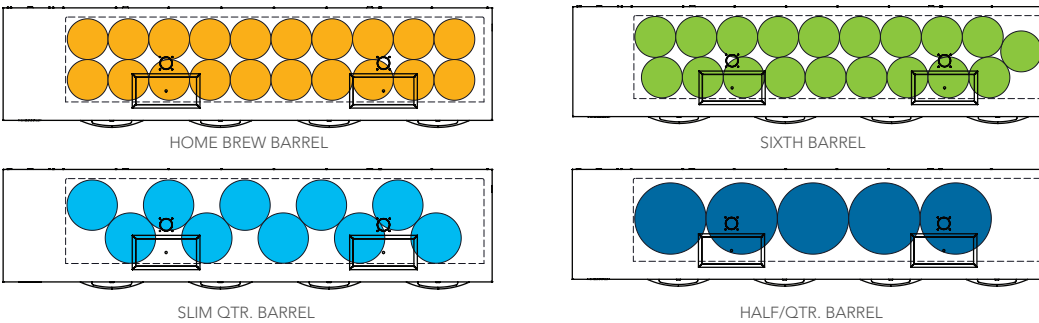

● Half/Quarter Barrel ● Slim Quarter Barrel ● Sixth Barrel ● Home Brew Barrel

* Top view shown. Please consult your beer distributor for specific sizes.
† 25-25/32" usable interior height.



Bar Refrigeration | Panel Ready Doors

TBR™/TDR™ PANEL READY DOORS

Match your style and decor!

True's line of refrigerated bar equipment now offers the option of Panel Ready Doors* which allow you to **enhance any bar with a custom look to match your cabinetry.**



TBR52-ROSZ1-R-B-SG-1

Please scan the QR code to access the TBR | TDR Bar Refrigeration Installation Manual and refer to the "Overlay Panel Specifications" (Pages 15-20).



Please Note

- True **does not** manufacture custom overlay panels.
- True cabinets with panel ready doors will ship **without** finished panels in place. (See black cabinet shown above).
- **Detailed drawings and measurements** are provided in the install manuals for aftermarket production of overlay panels.

Your cabinet will come without finished front panels but **ready for custom after-market panel installation** to further customize the look and style of your equipment.

Available on all TBR and TDR models.

*Custom overlay panels not sold by True. Cabinet ships ready for custom panel installation.

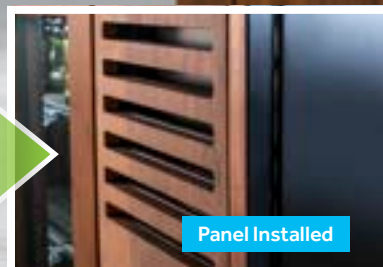



COMMERCIAL ICE MACHINES



With durable construction, True Ice® machines are built to thrive in any environment while maximizing ice production and reducing energy consumption. Additionally, True Ice® will change the game when it comes to ease of use and serviceability. Equipped with a smart board and 4.3" touch screen, True Ice® machines allow for diagnosing service issues, monitoring ice levels and simple yet effective cleaning routines.

TRUE ICE® NOMENCLATURE

Model Family

TCI | True Cubed Ice

TFI | True Flaked Ice

TNI | True Nugget Ice

TGI | True Gourmet Ice

Ice Capacity

(x100 lb/day)

Electrical Configuration

1 | 115V/60Hz/1Ø

2 | 230V/60Hz/1Ø

3 | 230V/50Hz/1Ø

4 | 230V/60Hz/3Ø

5 | 480V/60Hz/3Ø

Cube Size

H | Half

F | Full

L | Large

TCIM-422-HA1-A

Style

M | Modular

U | Undercounter

D | Dispenser

Width

(in.)

Condenser Type

A | Air

W | Water

R | Remote





True Ice Series | TCIM

MODULAR CUBED ICE MACHINE & SLOPED FRONT STORAGE BINS

TrueTech™ Aluminum Front & Sides

Sanitizes and purifies surrounding air from bin & food zone



4-3/8" (112 mm) front display – largest in the industry



TCIM-630-HA1-A



True Monitoring Solutions™

- Remote monitoring capabilities with easy back-end data access
- Location based performance enhancement plus low level ice protection
- Remote shut off



TCIM-430-HA1-A



TCIM-522-HA1-A



TCIM-622-HA1-A



TCIM-630-HA1-A



TCIM-822-HA1-A

* models shown mounted on slope front storage bins (TIB). TIB sold separately.

Features/Benefits

- Wide operating range: 35°F (1.7°C) to 110°F (43.3°C) ambient temperature. 35°F (1.7°C) to 100°F (37.7°C) water temperature.
- Construction - TrueTech™ aluminum front and sides, all plastic interior and single piece case for both 22" (559 mm) & 30" units (762 mm).
- Ultra quiet fan operation.
- Simple touch operation.
- Advanced diagnostics which allows for predictive and proactive measures.
- Built-in alarms & push notifications.
- Programmable ice production.
- Time of flight ice sensor eliminates the need for bin & dispenser thermostats.
- High & low pressure transducers for gauge-free servicing.
- Micro channel condenser for superior efficiency.
- No harvest assist necessary.
- Sanitary evaporator fully insulated & sealed for efficiency and cleanliness.
- High performance copper evaporator plate.



TCIM MODULAR CUBED ICE MACHINE

Model	Ice Production per 24hr - lb. (kg.)†	Ice Production per 24hr - lb. (kg.)*	Potable Water Consumption*	Electical Consumption*	Peak Heat of Rejection (BTU/hr)	Amps	Crated Weight lb. (kg.)	Cabinet Dimensions W D H* (in)	Cabinet Dimensions W D H* (mm)
ALUMINUM EXTERIOR									
TCIM-422-HA1-A**	450 (204)	348(158)	15.2 gal/100lb (58L/46 kg)	4.47 kWh/100lb (4.47 kWh/46kg)	5700	15	164 (74)	22 x 24 x 22	559 x 610 x 559
TCIM-422-FA1-A	440 (200)	330(150)	15.2 gal/100lb (58L/46 kg)	4.65 kWh/100lb (4.65 kWh/46kg)	5700	15	164 (74)	22 x 24 x 22	559 x 610 x 559
TCIM-422-LA1-A	430 (195)	310 (141)	15.2 gal/100lb (58L/46 kg)	4.80 kWh/100lb (4.80 kWh/46kg)	5700	15	164 (74)	22 x 24 x 22	559 x 610 x 559
TCIM-430-HA1-A**	450 (204)	346 (157)	14.9 gal/100lb (57L/46 kg)	4.27kWh/100lb (4.27 kWh/46kg)	5800	15	184 (84)	30 x 24 x 22	767 x 610 x 559
TCIM-430-FA1-A	440 (200)	330(150)	14.9 gal/100lb (57L/46 kg)	4.45 kWh/100lb (4.45 kWh/46kg)	5800	15	184 (84)	30 x 24 x 22	767 x 610 x 559
TCIM-430-LA1-A	430 (195)	310 (141)	14.9 gal/100lb (57L/46 kg)	4.60 kWh/100lb (4.60kWh/46kg)	5800	15	184 (84)	30 x 24 x 22	767 x 610 x 559
TCIM-522-HA1-A**	550 (250)	485 (220)	14.2 gal/100lb (54L/46 kg)	4.19 kWh/100lb (4.19 kWh/46kg)	7600	15	162 (74)	22 x 24 x 22	559 x 610 x 559
TCIM-522-FA1-A	535 (243)	465 (211)	14.2 gal/100lb (54L/46 kg)	4.40 kWh/100lb (4.40 kWh/46kg)	7600	15	162 (74)	22 x 24 x 22	559 x 610 x 559
TCIM-522-LA1-A	520 (236)	445 (202)	14.2 gal/100lb (54L/46 kg)	4.60 kWh/100lb (4.40 kWh/46kg)	7600	15	162 (74)	22 x 24 x 22	559 x 610 x 559
TCIM-530-HA1-A**	590 (268)	489 (222)	14.2 gal/100lb (54L/46 kg)	3.92 kWh/100lb (3.92 kWh/46kg)	7400	15	185 (84)	30 x 24 x 22	767 x 610 x 559
TCIM-530-FA1-A	575 (261)	470 (213)	14.2 gal/100lb (54L/46 kg)	4.15 kWh/100lb (4.15 kWh/46kg)	7400	15	185 (84)	30 x 24 x 22	767 x 610 x 559
TCIM-530-LA1-A	560 (254)	450 (204)	14.2 gal/100lb (54L/46 kg)	4.30 kWh/100lb (4.30 kWh/46kg)	7400	15	185 (84)	30 x 24 x 22	767 x 610 x 559
TCIM-622-HA1-A**	630 (286)	544 (247)	14.2 gal/100lb (54L/46 kg)	4.02 kWh/100lb (4.02 kWh/46kg)	8500	15	184 (84)	22 x 24 x 27	559 x 610 x 686
TCIM-622-FA1-A	615 (279)	525 (238)	14.2 gal/100lb (54L/46 kg)	4.02 kWh/100lb (4.02 kWh/46kg)	8500	15	184 (84)	22 x 24 x 27	559 x 610 x 686
TCIM-622-LA1-A	600 (272)	505 (229)	14.2 gal/100lb (54L/46 kg)	4.02 kWh/100lb (4.02 kWh/46kg)	8500	15	184 (84)	22 x 24 x 27	559 x 610 x 686
TCIM-630-HA1-A**	630 (286)	556 (252)	13.8 gal/100lb (53L/46 kg)	3.95 kWh/100lb (3.95 kWh/46kg)	8500	15	190 (86)	30 x 24 x 22	767 x 610 x 559
TCIM-630-FA1-A	615 (279)	508 (231)	14.2 gal/100lb (54L/46 kg)	4.25 kWh/100lb (4.25 kWh/46kg)	8500	15	190 (86)	30 x 24 x 22	767 x 610 x 559
TCIM-630-LA1-A	600 (272)	510 (232)	14.2 gal/100lb (54L/46 kg)	4.45 kWh/100lb (4.45 kWh/46kg)	8500	15	190 (86)	30 x 24 x 22	767 x 610 x 559
TCIM-822-HA1-A**	830 (377)	636 (289)	15.5 gal/100lb (59L/46 kg)	4.98 kWh/100lb (4.98 kWh/46kg)	10200	15	190 (86)	22 x 24 x 30	559 x 610 x 762
TCIM-822-FA1-A	800 (363)	646 (293)	14.5 gal/100lb (55L/46 kg)	4.82 kWh/100lb (4.82 kWh/46kg)	10200	15	190 (86)	22 x 24 x 30	559 x 610 x 762
TCIM-822-LA1-A	780 (354)	630 (286)	14.5 gal/100lb (55L/46 kg)	4.95 kWh/100lb (4.95 kWh/46kg)	10200	15	190 (86)	22 x 24 x 30	559 x 610 x 762
TCIM-830-HA1-A**	830 (376)	715 (325)	14.2 gal/100lb (54L/46 kg)	4.75 kWh/100lb (4.75 kWh/46kg)	10200	15	210 (95)	30 x 24 x 25	767 x 610 x 635
TCIM-830-FA1-A	800 (363)	650 (295)	14.2 gal/100lb (54L/46 kg)	4.85 kWh/100lb (4.85 kWh/46kg)	10200	15	210 (95)	30 x 24 x 25	767 x 610 x 635
TCIM-830-LA1-A	780 (354)	630 (286)	14.2 gal/100lb (54L/46 kg)	4.95 kWh/100lb (4.95 kWh/46kg)	10200	15	210 (95)	30 x 24 x 25	767 x 610 x 635

† at 70°F (21.1°C) air/50°F (10°C) water.

* at 90°F (33.2°C) air/70°F (21.1°C) water.

** Energy Star Model.

Water pressure: 20 psi (138 kPa) - 100psi (689 kPa).

Ice Cube Dimensions - inches (mm)	
Half	7/16" x 1-1/8" x 7/8" (11.1 x 28.6 x 22.2)
Full	7/8" x 7/8" x 7/8" (22.2 x 22.2 x 22.2)
Large	1-1/8" x 1-1/8" x 7/8" (28.6 x 28.6 x 22.2)



Environmentally friendly R290 hydrocarbon refrigeration system for the best in food preservation.



MODULAR ICE STORAGE BINS

TrueTech™ Aluminum Front & Sides, Slow-close hinged door



Magnascoop® included for easy ice scoop storage



Heavy duty slow-close plastic lid and hinge design

Tru-tech™ aluminum exterior

3" adjustable legs

TIB-530-A~T-1



TIB-322-A~T-1



TIB-422-A~T-1



TIB-430-A~T-1



TIB-948-A~T-1

Features/Benefits

Sloped Front Storage bins

- Tru-tech™ aluminum exterior with heavy duty plastic lid and frame.
- All plastic interior plus 100% antimicrobial plastic liner.
- Fully insulated with environmentally friendly high-density polyurethane foam.

- Slow Close Lid/Hinge design.
- Removable Ice Baffle.
- Magnascoop® included for easy ice scoop storage.
- 3" Adjustable legs.
- Adapter top for 22" machine head on 30" bin.



TIB SLOPE FRONT STORAGE BINS

Model	Capacity Weight lb. (kg.)	Crated Weight lb. (kg.)	Cabinet Dimensions W D† H* (in)	Cabinet Dimensions W D† H* (mm)
ALUMINUM EXTERIOR WITH PLASTIC LID & FRAME				
TIB-322-A~T-1	250 (114)	110 (50)	22 x 35 x 38	559 x 890 x 965
TIB-422-A~T-1	360 (164)	140 (64)	22 x 35 x 50	559 x 890 x 1270
TIB-430-A~T-1	365 (166)	150 (68)	30 x 35 x 38	762 x 890 x 965
TIB-530-A~T-1	515 (234)	180 (82)	30 x 35 x 50	762 x 890 x 1270
TIB-948-A~T-1	865 (393)	230 (105)	48 x 35 x 50	1219 x 890 x 1270

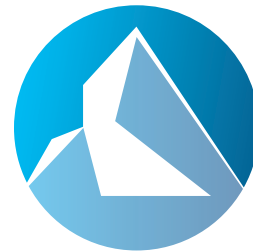



ACCESSORIES

True offers a large variety of accessories to compliment our cabinets, meeting the needs of our customers to customize their equipment for function and practicality in the busiest of locations.

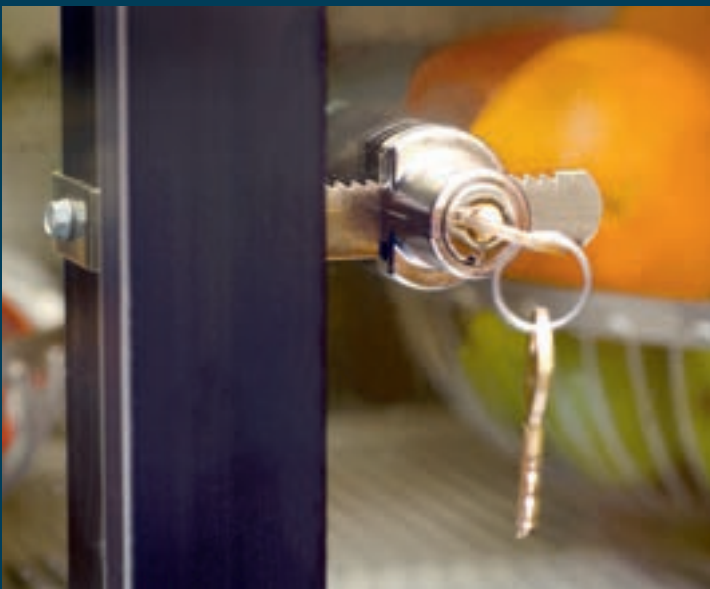

OEM Parts

Original Equipment Manufacturing Parts



Our experienced Global Customer Support Team combined with same day shipping gets you the parts you need when you need them.

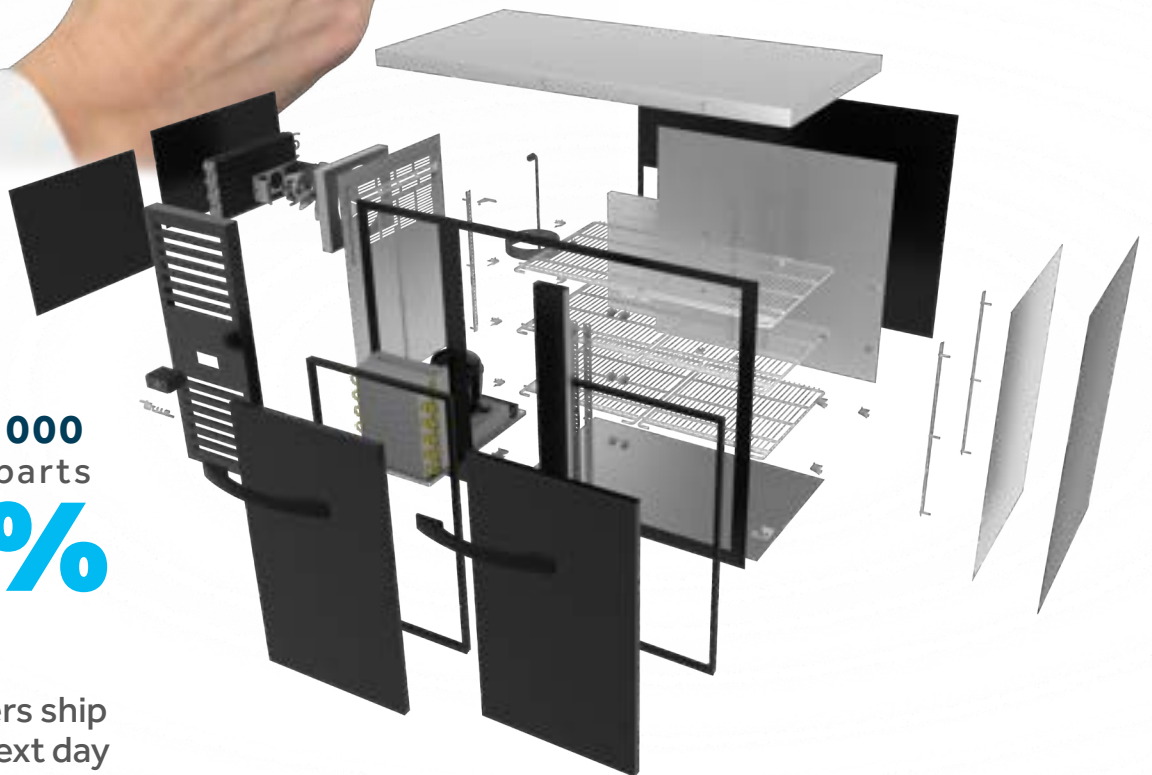

With over **100,000** ready-to-ship parts

80%

of True Parts orders ship out the same or next day

SPEC SERIES® OPTIONS

Legs & Castors

Description

- 6" (153mm) Legs (set of 4) - (stainless steel)
- 6" (153mm) Legs (set of 6) - (stainless steel)
- 6" (153mm) Legs (set of 4) - for one & two section units
- 6" (153mm) Seismic/Flanged Legs (set of 4) - for one & two section units
- 5" (127mm) Castors (set of 4) - for one & two section units w/brake
- 5" (127mm) Castors (set of 6) - 3 with brake & 3 without brake
- 3¼" (83mm) Castors (set of 4) - for one & two section units w/brake
- 3¼" (83mm) Castors (set of 6) - 3 with brake & 3 without brake



6" (153mm) Leg



6" (153mm) Seismic Leg

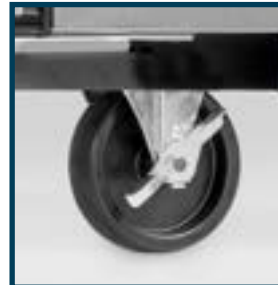

5" (127mm) Castor

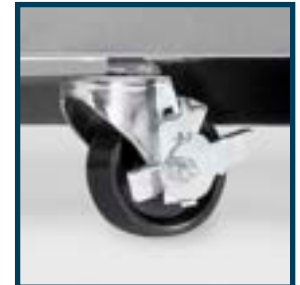

¾" (83mm) Castor

Shelving

Description

- PVC coated shelf
- Chrome plated shelf
- Stainless steel shelf

note: When ordering STR/STA/STG Series shelves please indicate model type and section in unit that shelf will be in (left, center, or right).



PVC coated wire shelf

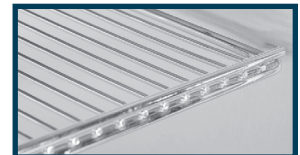

Chrome shelf

Hasp Lock

Description

- Single section hasp lock
- Double section hasp lock

note: Hasp locks not available on two section units with all right or all left hinges.



Single section hasp lock



Double section hasp lock

Accessories | Spec Series® Options

Interior Kit Options

Description

- Spec Kit #1 - (9) sets of #1 type tray slides and pilasters
- Spec. Kit #2 - (1) set of #2 type tray slides and pilasters (equips 1/2 section only)
- Spec. Kit #3 - (6) sets of universal type tray slides and pilasters
- Spec. Kit #4 - (3) chrome shelves and shelf supports**
(heated cabinets include wall mounted pilasters and shelf clips)
- #1 Type Tray Slide for (1) 18" x 26" (458mm x 661mm) or
(2) 14" x 18" (356mm x 458mm) pans - per set of 2 (STR/STA/STG)
- #2 Type Tray Slide for 18" x 26" (458mm x 661mm) pans per set of 2,
equips 1/2 section (STR/STA/STG)
- #3 Universal Type Tray Slide for (1) 18" x 26" (458mm x 661mm) or (2) 12" x 20" (305mm x 508mm)
or (2) 14" x 18" (356mm x 458mm) pans - per set of 2 (STR/STA/STG)
- #4 (1) Chrome shelf and shelf supports

note: when ordering interior kits for STR/STA/STG-Series units please indicate...

1. Model type
 2. Interior kit type and quantity (#1 type, #2 type, #3 type, #4 type)
 3. Section in unit that kit will be in (left, center, or right)
 4. Location in section that kit will be used in (top half, bottom half, full section)*
- * Pilasters are specific to interior kit type and are only available in half section and full section sizes.

** On refrigerators and freezers, shelves mounted with pilaster/clip assembly available in lieu of standard shelf support system if ordered with cabinet from factory.

† Pilasters and tray slides/shelving for STR series are factory installed at no charge. (please note: lead time is required depending on cabinet availability). Tray slides for STA/STG to be field installed.

Tray Slide	Spacings				
	2" 51mm	3" 77mm	4" 102mm	5" 127mm	6" 153mm
#1 Tray Slides					
Behind full door length	28	19	14	11	10
Behind upper half door	13	9	7	5	5
Behind lower half door	13	9	7	5	5
#2 Tray Slides 39mm O.C.	2" 51mm	3" 77mm	4" 102mm	5" 127mm	6" 153mm
Behind full door length	38				
Behind upper half door	18	not available			
Behind lower half door	18	not available			
Universal Tray Slides	2" 51mm	3" 77mm	4" 102mm	5" 127mm	6" 153mm
Behind full door length			14	11	9
Behind upper half door	not available		6	5	4
Behind lower half door			6	5	4



TYPE 1

16 ga. Stainless Steel
For Bottom Support of:
(1) 18" x 26" (458mm x 661mm) pan or
(2) 14" x 18" (356mm x 458mm) pan

Angle type tray slide



TYPE 2

Chrome Plated Steel Rod Type
For Rim Support of:
(1) 18" x 26" (458mm x 661mm) pan
note: One pair of #2 tray slides
accommodates one half section.
for light duty applications only.
Not available for ST()1DT-2HS-HC

Rod type tray slide



TYPE 3

16 ga. Stainless Steel
Angle Type for Bottom Support of:
(1) 18" x 26" (458mm x 661mm) pan or
(2) 14" x 18" (356mm x 458mm) pans or
(2) 12" x 20" (305mm x 508mm) pans

Universal tray slide



TYPE 4

Chrome Shelves:
Standard in STR & STA Series
refrigerators & freezers.
Stainless steel shelves also available.
PVC Coated Shelves:
Standard in STG refrigerators & freezers.

Chrome and PVC coated shelves with supports

Security Options - Reach-In & Pass Thru's

SECURITY PACKAGE 1

Reach-In/Pass-Thru Refrigerators & Freezers

Reach-In/Pass-Thru Heated Cabinets

Includes all correctional options below
 Tamper-proof Rainshield, Stainless Breaker Covers, Light Cover, Locking Hasp(s),
 Non-Removable Doors, Control Cover, Top Screen/Guards, Security Screws (includes/Requires Top
 Screen), Welded Tray Slides*, & Seismic/Flanged Legs. Remove Hinge Covers & True Logo.

SECURITY PACKAGE 2

Reach-In/Pass-Thru Refrigerators & Freezers

Reach-In/Pass-Thru Heated Cabinets

Includes the following, Tamper-proof Rainshield, Stainless Breaker Covers, Locking Hasp(s), Control
 Cover, & Seismic/Flanged Legs. Remove Hinge Covers & True Logo.

SECURITY PACKAGE 3

Reach-In/Pass-Thru Refrigerators & Freezers

Reach-In/Pass-Thru Heated Cabinets

Tamper-proof Rainshield, Locking Hasp(s) only (Padlock not included).

*12 sets of welded universal tray slides per door opening. Sold separately. Contact Factory for details.
 note: Individual security options or alternative combinations are available if needed. Contact Factory
 for details.

note: The inclusion of all options on the models listed above adheres to the Chapter XIV section 1400
 American Correctional Food Service Association Standard Number 1 Equipment Specifications Correctional
 Package Correctional Food Service requirements.

note: Hasp locks not available on two section units with all-right or all left hinges.



Mesh screening



Hinged locking
 thermostat control cover



Tamper proof rain
 shield (standard)



Locking hasp



Seismic/flanged leg



Stainless steel thermal
 breaker (interior)



Heavy duty, security
 light cover (interior)



Tray slides & pilaster in
 fixed/welded rack



Hinges without covers



Security screws

Security Options - Roll-In & Roll Thru's

SECURITY PACKAGE 1

Roll-In/Roll-Thru Refrigerators & Freezers

Roll-In/Roll-Thru Heated Cabinets

Includes all correctional options below
 Tamper-proof Rainshield, Stainless Breaker Covers, Light Cover, Locking Hasp(s), Non-Removable
 Doors, Control Cover, Top Screen/Guards, & Security Screws (includes/Requires Top Screen).
 Remove Hinge Covers & True Logo.

SECURITY PACKAGE 2

Roll-In/Roll-Thru Refrigerators & Freezers

Roll-In/Roll-Thru Heated Cabinets

Includes the following, Tamper-proof Rainshield, Stainless Breaker Covers, Locking Hasp(s), &
 Control Cover. Remove Hinge Covers & True Logo.

SECURITY PACKAGE 3

Roll-In/Roll-Thru Refrigerators & Freezers

Roll-In/Roll-Thru Heated Cabinets

Tamper-proof Rainshield, Locking Hasp(s) only (Padlock not included).

note: Individual security options or alternative combinations are available if needed. Contact Factory
 for details.

note: The inclusion of all options on the models listed above adheres to the Chapter XIV section 1400
 American Correctional Food Service Association Standard Number 1 Equipment Specifications Correctional
 Package Correctional Food Service requirements.

note: Hasp locks not available on two section units with all-right or all left hinges.



STR2R-2S Security Package

SHELVING

PVC Coated Wire Shelves

Description

Standard Shelves

Wire Cantilever Shelves

Description

FLM-27/FLM-27F White

FLM-27/FLM-27F Black

FLM-54/54F/FLM-81/81F White

FLM-54/54F/FLM-81/81F Black

TCGG-36/-S-LD (with light assembly)

TCGG-48/-S-LD (with light assembly)

TCGG-60/-S-LD (with light assembly)(left side)

TCGG-60/-S-LD (with light assembly)(right side)

TCGG-72/-S-LD (with light assembly)

Solid Cantilever Shelves

Description

FLM-27/FLM-27F White

FLM-27/FLM-27F Black

FLM-27/FLM-27F Stainless Steel

FLM-54/54F/FLM-81/81F White

FLM-54/54F/FLM-81/81F Stainless Steel

TVM Shelves

TOAM-30GS-HC-White

TOAM-30GS-HC-Black

TOAM-30GS-HC-Stainless Steel

Chrome Plated Shelves

Description

Chrome Shelves for TH-23 & TH-23G~FGD01

Price Strips

Description

Price Strips



Wire Shelf

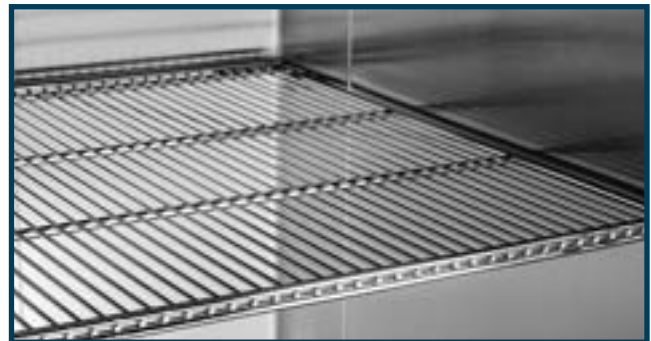

Chrome Shelf



Stainless Steel Cantilever Shelf



Price Strip mounted on wire shelf

Note: Lighted shelves for display cases are limited to the number of receptacles included with the cabinet. Order by model number.

Shelf Organizers

Description	
20 oz. TrueFlex**	
20 oz. TrueTrac**	
1 liter TrueTrac®	
True Flex-Pack® (TVM-30-HC)	
True Flex-Pack® (TVM-36-HC)	

* Most cooler sizes will utilize the TrueFlex® Organizers
 TrueFlex® Organizers not available for the following models (TrueTrac® required)
 GDM-10PT-HC~TSL01, GDM-33CPT-54-LD, GDM-33SSL-56-HC-LD, GDM-35SL-RF-HC-LD, GDM-41SL-54-HC-LD, GDM-41SL-60-HHC-LD, GDM-41SL-HC-LD.
 TrueFlex® & TrueTrac® organizers are not available for 10SSL-HC~TSL01.
 TrueFlex® organizers available for all back bar models.
 TrueFlex® organizers require existing or optional shelf for installation.
 **For GDM-35SLRF-HC, GDM-33CPT-LD, & GDM-33CPT-54-LD models only.

TrueFlex® Beer Organizers

Description	Quantity
27" (686MM) DEEP MODELS	
TBB-2-HC	26
TBB-3-HC	34
TBB-4-HC	46
24" (610MM) DEEP MODELS	
TBB24-48-HC	20
TBB24-60-HC	28
TBB24-72-HC	36

Wine Shelves

Description
GDM-23-HC~TSL01, GDM-45-HC-LD
GDM-47-HC-LD, TSD-47-HD
GDM-69-HC-LD, GDM-72-HC~TSL01, T-72-HC, TSD-69, TBB-2-HC, TBB-3-HC, TBB-4-HC
FLM-27/FLM-27F White
FLM-27/FLM-27F Black
FLM-27/FLM-27F Gray
FLM-54/54F/FLM-81-81F White
FLM-54/54F/FLM-81-81F Black
FLM-54/54F/FLM-81-81F Gray

Sliding Wine Racks

Description
GDM-23-HC~TSL01
GDM-23W-HC~TSL01



TrueTrac® (standard with 3/4" (19mm) price strip)

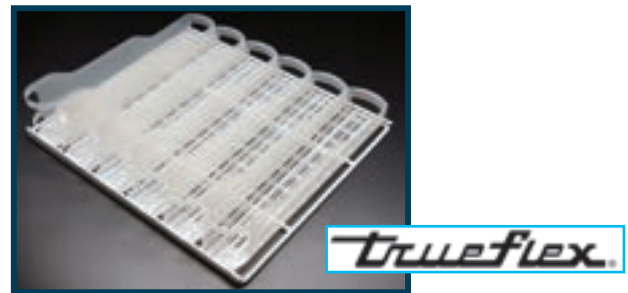

TrueFlex® Organizer



TrueFlex® Beer Organizer



Wine rack



Sliding wine rack

RACKS & BASKETS

Bun Tray Racks

Description	Dimensions (W x D x H)
Full Door T, TH, TS*	20 $\frac{7}{8}$ x 24 x 51 (531 x 610 x 1296)
Half Door T, TH, TS, TPP-AT-44, 60, -67, -93, -119 TUC/TWT-44-HC, 60-32-HC, -67-HC**	20 $\frac{7}{8}$ x 24 x 22 $\frac{1}{2}$ (531 x 610 x 572)
T-35-HC, 35G-HC~FGD01, T-43-HC Full Door	16 x 24 x 51 (407 x 610 x 1296)
T-35-HC, 35G-HC~FGD01, T-43-HC Half Door	16 x 24 x 22 $\frac{1}{2}$ (407 x 610 x 572)
Bun Tray Runner, Standard	19 $\frac{3}{4}$ x 1 $\frac{1}{2}$ x 1 $\frac{1}{16}$ (502 x 39 x 27)
Bun Tray Runner, Universal***	19 $\frac{3}{4}$ x 5 $\frac{1}{4}$ x 2 $\frac{1}{4}$ (502 x 134 x 58)

Full door racks do not fit in half door models.

Not designed for TSD or GDM models.

* Not available for freezer models, T-12-HC/T-19-HC/-19G-HC~FGD01/T-35-HC/ T-35G-HC~FGD01, TH-23G~FGD01 or T-23DT-HC freezer section.

** Not available for freezer models, T-12-HC/T-19-HC/-19G-HC~FGD01/T-35-HC/ T-35G-HC~FGD01, TH-23G~FGD01 or T-23DT-HC freezer section. Not available for TPP/deep TUC/TWT-60-HC, 60-32-HC (left door).

***Two (2) universal runners accommodate (1) 18" x 26" (458mm x 661mm) or (1) 20" x 12" (505mm x 305mm) pan.

Full Door Bun Tray Rack can utilize 32 universal runners maximum to hold 16 pans. Half Door Bun Tray Rack can utilize 12 universal runners maximum to hold 6 pans.

note: Full door rack features 44 standard runners to hold 22 sheet pans. Maximum capacity is 32, 18" x 26" (458mm x 661mm) sheet pans. Half door bun tray rack features 22 standard runners to hold 11 sheet pans. Maximum capacity is 13, 18" x 26" (458mm x 661mm) sheet pans.

note: In T-Freezers the backguards will have to be removed prior to installing bun tray racks.

Novelty Basket

Description	Dimensions (W x D x H)
GDM- & T- models 23-HC, 23F-HC, 43F-HC, 49-HC, 49F-HC, 72-HC, 72F-HC (3 dividers std.)	19 $\frac{1}{4}$ x 21 $\frac{3}{4}$ x 5 (489 x 553 x 127)
Extra dividers (each)	
GDM-12-HC~TSL01, 12F-HC~TSL01 & T-models 12-HC, 12F-HC, 12FG-HC~FGD01,	19 $\frac{1}{4}$ x 17 $\frac{1}{2}$ x 5 (489 x 435 x 127)
Extra dividers (each)	

note: Basic models listed; consult factory for specific model compatibility.

Hanging Novelty Basket

Description
GDM-10-HC~TSL01/10F-HC~TSL01/12-HC~TSL01/12F-HC~TSL01 (set of 3, includes dividers)
Extra dividers (each)



Full Bun Tray Rack



Half Bun Tray Rack



Novelty Basket (sits on wire shelf)

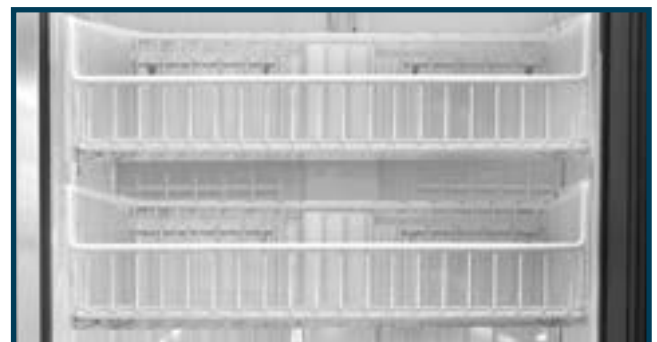

Hanging Novelty Basket

FLAT LID OPTIONS

TSSU Models

Description	Number of Lids	Number of Pans
TSSU-27-08-HC	1	8
TSSU-36-08-HC	1	8
TSSU-48-08-HC	1	8
TSSU-48-10-HC	1	10
TSSU-48-12-HC	1	12
TSSU-60-08-HC	1	8
TSSU-60-10-HC	1	10
TSSU-60-12-HC	1	12
TSSU-60-16-HC*	2	8 / 8
TSSU-72-08-HC	1	8
TSSU-72-10-HC	1	10
TSSU-72-12-HC	1	12
TSSU-72-16-HC*	2	8 / 8
TSSU-72-18-HC*	2	10 / 8

*Unit now becomes a split top with two pan openings.
 note: Flat lids are factory installed, contact customer service for lead time.

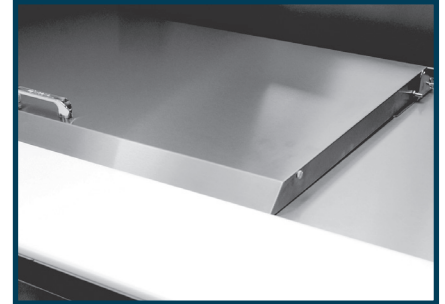

TSSU flat lid option

TSSU Mega Top Models

Description	Number of Lids	Number of Pans
TSSU-27-12M-B/-C-HC	1	12
TSSU-36-12M-B-HC	1	12
TSSU-48-12M-B-HC	1	12
TSSU-48-15M-B-HC	1	15
TSSU-48-18M-B-HC	1	18
TSSU-60-12M-B-HC	1	12
TSSU-60-15M-B-HC	1	15
TSSU-60-18M-B-HC	1	18
TSSU-60-24M-B-ST-HC	2	12 / 12
TSSU-72-12M-B-HC	1	12
TSSU-72-15M-B-HC	1	15
TSSU-72-18M-B-HC	1	18
TSSU-72-24M-B-ST-HC	2	12 / 12
TSSU-72-30M-B-ST-HC	2	12 / 18

note: Flat lids are factory installed, contact customer service for lead time.

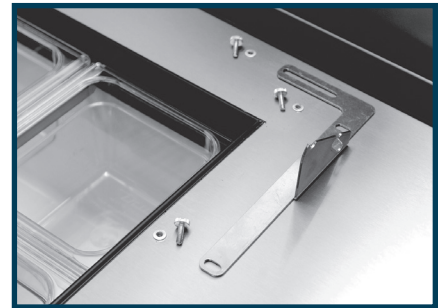

Bracket hardware utilizes existing screw holes.

TFP Models

Description	Number of Lids	Number of Pans
TFP-32-12M	1	12
TFP-32-12M-D-2	1	12
TFP-48-18M	1	18
TFP-48-18M-D-4	1	18
TFP-64-24M	2	24
TFP-64-24M-D-2	2	24
TFP-64-24M-D-4	2	24
TFP-72-30M	2	30
TFP-72-30M-D-2	2	30
TFP-72-30M-D-6	2	30

note: Flat lids are factory installed, contact customer service for lead time.

PLEXIGLASS LID OPTION

TSSU Model

Description
TSSU-27



Plexiglass Lid Option (TSSU-27)

Accessories | Prep Table Options • Shelf Kits

FOOD & PIZZA PREP OPTIONS

SneezeGuard

Description

TSSU-27-HC
TSSU-36-HC
TSSU-48-HC
TSSU-60-HC
TSSU-72-HC
TSSU-27 Mega-HC
TSSU-36 Mega-HC
TSSU-48 Mega-HC
TSSU-60 Mega-HC
TSSU-72 Mega-HC

note: Not available for dual sided models.



SneezeGuard

Garnish Racks

Description

Number of Racks

TPP-AT-44-HC	1
TPP-AT-60-HC	1
TPP-AT-67-HC	1
TPP-AT2-93-HC	1 set (of 2)
TPP-AT-119-HC	1 set (of 2)
Garnish Rack Pan	18 $\frac{3}{4}$ " x 12 $\frac{7}{8}$ " (477mm x 327mm)



Garnish Rack

Crumb Catcher

Description

TSSU-27-HC
TSSU-36-HC
TSSU-48-HC
TSSU-60-HC
TSSU-72-HC

note: All size crumb catchers require right side bracket (item number 224096) and left side bracket (item number 224097)

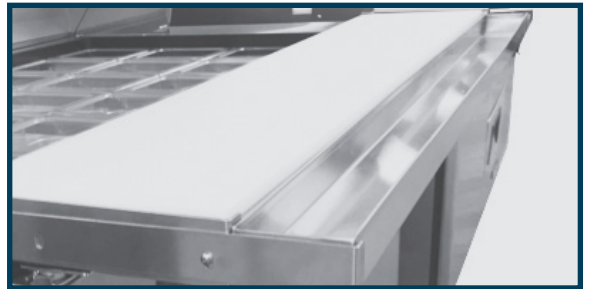

Crumb Catcher

Integrated Toppings Catcher

Description

TPP-AT-44-HC
TPP-AT-60-HC
TPP-AT-67-HC
TPP-AT2-93-HC
TPP-AT-119-HC



Integrated Toppings Catcher

SHELF KITS

Basic Overshelf

Description

Dimensions (W x D x H)

TSSU/TUC/TWT-27-HC	25 $\frac{1}{2}$ x 9 x 14 $\frac{3}{8}$ (639 x 229 x 366)
TSSU/TUC/TWT-36-HC	34 $\frac{1}{8}$ x 9 x 14 $\frac{3}{8}$ (866 x 229 x 366)
TSSU/TUC/TWT-48-HC	46 $\frac{1}{8}$ x 9 x 14 $\frac{3}{8}$ (1170 x 229 x 366)
TSSU/TUC/TWT-60-HC	58 $\frac{1}{8}$ x 9 x 14 $\frac{3}{8}$ (1475 x 229 x 366)

Made of heavy-gauge stainless steel.

note: Overshelf not available for TWT/TUC-60-32. Overshelf not available for dual sided models.
note: Height dimension from countertop to shelf top.



Basic Overshelf (TSSU/TUC/TWT)

SHELF KITS (cont.)

Sandwich/Salad Service Shelf (TSSU/TUC/TWT)

Description	Dimensions (W x D x H)
TSSU-36/TUC/TWT-36-HC	36 $\frac{3}{8}$ x 12 x 14 $\frac{1}{4}$ (913 x 305 x 326)
TSSU/TUC/TWT-48-HC	48 $\frac{3}{8}$ x 12 x 14 $\frac{1}{4}$ (1236 x 305 x 326)
TSSU/TUC/TWT-60-HC	60 $\frac{3}{8}$ x 12 x 14 $\frac{1}{4}$ (1540 x 305 x 326)
TSSU/TUC/TWT-72-HC	72 $\frac{3}{8}$ x 12 x 14 $\frac{1}{4}$ (1845 x 305 x 326)

Made of heavy-gauge stainless steel.
 Sandwich/salad service shelf not available for Non Dual Sided Mega-Tops.
 note: Service shelf not available for TSSU-60-16-HC, TSSU-60-16-DS-ST-HC, TUC/TWT-60-32-HC.
 note: For use with dual sided, mega-top units, pan lids must be removed, lids will not hinge open.
 note: Height dimension from countertop to shelf top.



Sandwich/Salad Service Shelf (TSSU/TUC/TWT)

Pizza Prep Service Shelf

Description	Dimensions (W x D x H)
TPP-AT-44-HC	44 x 17 $\frac{7}{8}$ x 18 $\frac{1}{8}$ (1118 x 455 x 461)
TPP-AT-60-HC	60 $\frac{3}{8}$ x 17 $\frac{7}{8}$ x 18 $\frac{1}{8}$ (1540 x 455 x 461)
TPP-AT-67-HC	67 $\frac{3}{8}$ x 17 $\frac{7}{8}$ x 18 $\frac{1}{8}$ (1718 x 455 x 461)
TPP-AT2-93-HC	93 $\frac{3}{8}$ x 17 $\frac{7}{8}$ x 18 $\frac{1}{8}$ (2379 x 455 x 461)

Made of heavy-gauge stainless steel.
 note: Height dimension from countertop to shelf top.



Pizza Prep Service Shelf (TPP only)

OverShelf Kits (Single/Double)

Description	Dimensions (W x D x H*)
SINGLE OVERSHELVES	
TSSU/TUC/TWT-27 & Mega-HC	27 $\frac{3}{8}$ x 16 x 20 $\frac{1}{2}$ (702 x 407 x 509)
TSSU/TUC/TWT-36 & Mega-HC	36 $\frac{3}{8}$ x 16 x 20 $\frac{1}{2}$ (624 x 407 x 509)
TSSU/TUC/TWT-48 & Mega-HC	48 $\frac{3}{8}$ x 16 x 20 $\frac{1}{2}$ (1229 x 407 x 509)
TSSU/TUC/TWT-60 & Mega-HC	60 $\frac{3}{8}$ x 16 x 20 $\frac{1}{2}$ (1534 x 407 x 509)
TSSU/TUC/TWT-72 & Mega-HC	72 $\frac{3}{8}$ x 16 x 20 $\frac{1}{2}$ (1839 x 407 x 509)
TPP/TUC/TWT-44-HC	44 $\frac{3}{8}$ x 16 x 20 $\frac{1}{2}$ (1134 x 407 x 509)
TPP-AT-60, TUC/TWT-60-32-HC	60 $\frac{3}{8}$ x 16 x 20 $\frac{1}{2}$ (1534 x 407 x 509)
TPP-AT/TUC/TWT-67-HC	67 $\frac{3}{8}$ x 16 x 20 $\frac{1}{2}$ (1712 x 407 x 509)
TFP-32	32 $\frac{3}{8}$ x 16 x 43 $\frac{1}{2}$ (823 x 407 x 1105)
TFP-48	48 $\frac{3}{8}$ x 16 x 43 $\frac{1}{2}$ (1229 x 407 x 1105)
TFP-64	64 $\frac{3}{8}$ x 16 x 43 $\frac{1}{2}$ (1636 x 407 x 1105)
TFP-72	72 $\frac{3}{8}$ x 16 x 43 $\frac{1}{2}$ (1839 x 407 x 1105)
DOUBLE OVERSHELVES	
TSSU/TUC/TWT-27 & Mega-HC	27 $\frac{3}{8}$ x 16 x 33 $\frac{1}{2}$ (702 x 407 x 509)
TSSU/TUC/TWT-36 & Mega-HC	36 $\frac{3}{8}$ x 16 x 33 $\frac{1}{2}$ (624 x 407 x 509)
TSSU/TUC/TWT-48 & Mega-HC	48 $\frac{3}{8}$ x 16 x 33 $\frac{1}{2}$ (1229 x 407 x 509)
TSSU/TPP/TUC/TWT-60-HC & Mega/ TUC/TWT-60-32-HC	60 $\frac{3}{8}$ x 16 x 33 $\frac{1}{2}$ (1534 x 407 x 509)
TSSU/TUC/TWT-72 & Mega-HC	72 $\frac{3}{8}$ x 16 x 33 $\frac{1}{2}$ (1839 x 407 x 509)
TPP-AT-44 & TUC/TWT-44-HC	44 $\frac{3}{8}$ x 16 x 33 $\frac{1}{2}$ (1134 x 407 x 509)
TPP-AT-67 & TUC/TWT-67-HC	67 $\frac{3}{8}$ x 16 x 33 $\frac{1}{2}$ (1712 x 407 x 509)
TFP-32	32 $\frac{3}{8}$ x 16 x 56 $\frac{1}{2}$ (823 x 407 x 1436)
TFP-48	48 $\frac{3}{8}$ x 16 x 56 $\frac{1}{2}$ (1229 x 407 x 1436)
TFP-64	64 $\frac{3}{8}$ x 16 x 56 $\frac{1}{2}$ (1636 x 407 x 1436)
TFP-72	72 $\frac{3}{8}$ x 16 x 56 $\frac{1}{2}$ (1839 x 407 x 1436)

Made of heavy-gauge stainless steel.
 * maximum height, single overshelves and lower shelf on double overshelves are adjustable.
 note: Overshelves not available for dual sided models. Overshelves not available for TPP-AT-93 or -119 models.

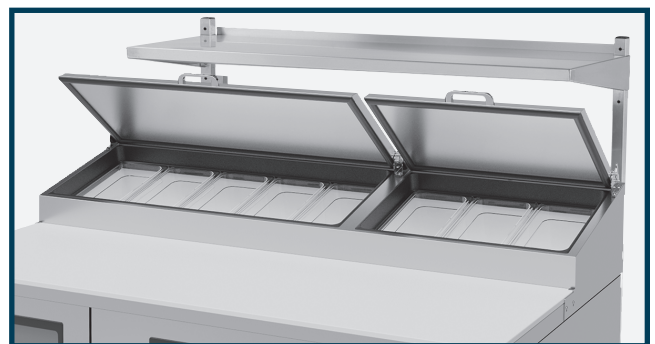

TPP-AT-60-HC (single overshelf)



TSSU-48-12-HC (double overshelf)

CASTORS & LEGS

Stem Castors & Legs

Description

GDM, TOAM, TVM, T-Series, Spec Series, Food Prep, TUC/TWT (set of 4)

GDM, TOAM, TVM, T-Series, Spec Series, Food Prep, TUC/TWT (set of 6)

TRCB (set of 4 - Legs only)

TRCB (set of 6 - Legs only)

TPP-AT-119-HC & TRCB-110 require 2 sets of 4

Castors are not available on GDM-05-HC-LD, GDM-05PT-HC-LD, GDM-07-HC~TSL01, GDM-09-SQ-HC-LD, hard wired models, & two section heated cabinets. Legs are not available on T-12-HC, T-12F-HC, T-12G-HC~FGD01/-12FG-HC~FGD01, GDM-10-HC~TSL01/-10F-HC~TSL01, GDM-12-HC~TSL01/GDM-12F-HC~TSL01/-12FC-HC~TSL01, GDM-33SSL-54-LD, TAC's, TDD-1/-S.



1 1/2" (39mm) Castor



2 1/2" (64mm) Castor



3" (77mm) Castor



4" (102mm) Castor



5" (127mm) Castor

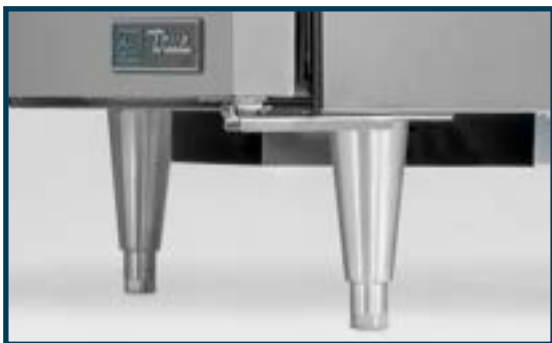

6" (153mm) Leg



6" (153mm) Seismic/Flanged Leg

CASTORS & LEGS (cont.)

Plate Castors

Description

T-50-GC-HC, TD-50-18-HC, TD-65-24-HC, TD-80-30-HC, TBB/TDD-2-HC, TBB/TDD-3-HC, TBB24-48/60/72-HC - 2½" (64mm) (set of 4)

TD-95-38-HC, TBB/TDD-4-HC - 2½" (64mm) (set of 4)

T-50-GC-HC, TD-50-18-HC, TD-65-24-HC, TD-80-30-HC, TBB/TDD-2-HC, TBB/TDD-3-HC, TBB24-48/60/72-HC - 3" (77mm) (set of 4)

TD-95-38-HC, TBB/TDD-4-HC - 3" (77mm) (set of 6)

TRCB (set of 4)

TRCB (set of 6)



Plate Castor

Stacking Collar

Description

TUC-27-HC, 27F-HC

True's stacking collar provides a space-efficient freezer and refrigerator combination in a 27½" x 30" (699mm x 726mm) footprint. Includes anti-tip bracket and 6" (153mm) seismic legs.



Stacking Collar

CUTTING BOARDS

TSSU - White Polyethylene

Description	Dimensions (W x D)
19" (438mm) CUTTING BOARDS* - 1/2" (13mm) THICK (requires "L" brackets)	
TSSU-27-HC	27½ x 19 (699 x 483)
TSSU-36-HC	36 x 19 (915 x 483)
TSSU-48-HC	48 x 19 (1220 x 483)
TSSU-60-HC	60 x 19 (1524 x 483)
TSSU-72-HC	72 x 19 (1956 x 483)
19" (438mm) CUTTING BOARDS* - 3/4" (19mm) THICK (requires "L" brackets)	
TSSU-27-HC	27½ x 19 (699 x 483)
TSSU-48-HC	48 x 19 (1220 x 483)
TSSU-60-HC	60 x 19 (1524 x 483)
TSSU-72-HC	72 x 19 (1956 x 483)

"L" Brackets for 19" (438mm) Cutting Board (set) w/out rivnut tool

"L" Brackets for 19" (438mm) Cutting Board (set) w/rivnut tool

* 19" (483mm) cutting boards not available for TSSU with drawers, dual sided or mega top models.

TPP - White Polyethylene

Description	Dimensions (W x D)
19½" (496mm) CUTTING BOARDS - 1/2" (13mm) THICK (use existing brackets)	
TPP-AT-44-HC	44¼ x 19½ (1124 x 496)
TPP-AT-60-HC	60 x 19½ (1524 x 496)
TPP-AT-67-HC	67 x 19½ (1702 x 496)
TPP-AT2-93-HC	93 x 19½ (2363 x 496)
TPP-AT-119-HC	119 x 19½ (3023 x 496)

TUC & TWT - White Polyethylene

Description	Dimensions (W x D)
FULL TOP CUTTING BOARDS 1/2" (13mm) THICK (requires brackets)	
TUC-27-HC	27½ x 30 (699 x 762)
TUC-36-HC	36½ x 30 (915 x 762)
TUC-44-HC	44¼ x 32½ (1124 x 816)
TUC-48-HC	48 x 30 (1220 x 762)
TUC-60-HC	60 x 30 (1524 x 762)
TUC-60-32-HC	60 x 32½ (1524 x 816)
TUC-67-HC	67 x 32½ (1702 x 816)
TUC-72-HC	72 x 30 (1829 x 762)
TUC-93-HC	93¼ x 32½ (2369 x 816)
TWT-27-HC	27½ x 28¼ (699 x 718)
TWT-36-HC	36 x 28¼ (915 x 718)
TWT-44-HC	44¼ x 30 (1124 x 762)
TWT-48-HC	48 x 28¼ (1220 x 718)
TWT-60-HC	60 x 28¼ (1524 x 718)
TWT-60-32-HC	60 x 30 (1524 x 762)
TWT-67-HC	67 x 30w (1702 x 762)
TWT-72-HC	72 x 28¼ (1829 x 718)
TWT-93-HC	93¼ x 30 (2369 x 762)

"L" Brackets for TUC & TWT Cutting Board (set) w/out rivnut tool

"L" Brackets for TUC & TWT Cutting Board (set) w/rivnut tool

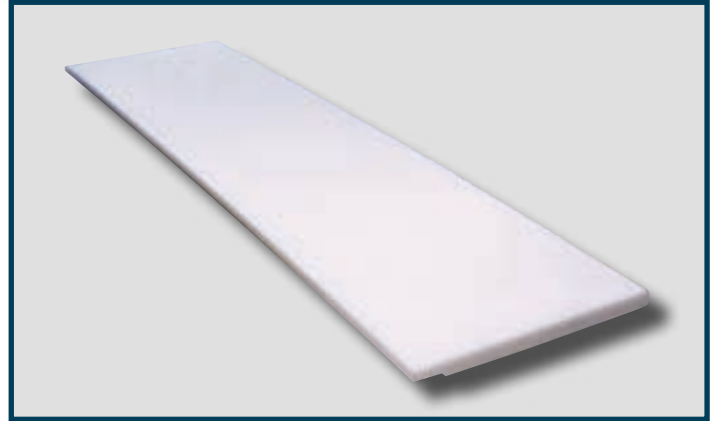

White, polyethylene cutting board.



White, polyethylene cutting board on cooler.

CUTTING BOARDS

TSSU - Composite

Description	Dimensions (W x D)
8 ⁷ / ₈ " (226mm) CUTTING BOARDS - 1/2" (13mm) THICK (no special brackets required)	
TSSU-27-HC	27 ¹ / ₂ x 19 (699 x 483)
TSSU-36-HC	36 x 19 (915 x 483)
TSSU-48-HC	48 x 19 (1220 x 483)
TSSU-60-HC	60 x 19 (1524 x 483)
TSSU-72-HC	72 x 19 (1956 x 483)
11 ³ / ₄ " (299mm) CUTTING BOARDS - 1/2" (13mm) THICK (requires "L" brackets - Mega)	
TSSU-27-HC	27 ¹ / ₂ x 19 (699 x 483)
TSSU-36-HC	36 x 19 (915 x 483)
TSSU-48-HC	48 x 19 (1220 x 483)
TSSU-60-HC	60 x 19 (1524 x 483)
TSSU-72-HC	72 x 19 (1956 x 483)
"L" Brackets for TSSU Mega Cutting Board (set) w/out rivnut tool	
"L" Brackets for TSSU Mega Cutting Board (set) w/rivnut tool	
19" (483mm) CUTTING BOARDS* - 1/2" (13mm) THICK (requires "L" brackets)	
TSSU-27-HC	27 ¹ / ₂ x 19 (699 x 483)
TSSU-36-HC	36 x 19 (915 x 483)
TSSU-48-HC	48 x 19 (1220 x 483)
TSSU-60-HC	60 x 19 (1524 x 483)
TSSU-72-HC	72 x 19 (1956 x 483)
"L" Brackets for 19"(483mm) Cutting Board (set) w/out rivnut tool	
"L" Brackets for 19"(483mm) Cutting Board (set) w/rivnut tool	

* 19" (483mm) cutting boards not available for TSSU with drawers, dual sided or mega top models.

TFP - Composite

Description	Dimensions (W x D)
8" (204mm) CUTTING BOARDS - 1/2" (13mm) THICK (use existing brackets)	
TFP-32M	32 x 8 (813 x 204)
TFP-48M	48 x 8 (1220 x 204)
TFP-64M	64 x 8 (1626 x 204)
TFP-72M	72 x 8 (1829 x 204)

TPP - Composite

Description	Dimensions (W x D)
19 ¹ / ₂ " (496mm) CUTTING BOARDS - 1/2" (13mm) THICK (use existing brackets)	
TPP-AT-44-HC	44 ¹ / ₄ x 19 ¹ / ₂ (1124 x 496)
TPP-AT-60-HC	60 x 19 ¹ / ₂ (1524 x 496)
TPP-AT-67-HC	67 x 19 ¹ / ₂ (1702 x 496)
TPP-AT-93-HC	93 x 19 ¹ / ₂ (2363 x 496)
TPP-AT-119-HC	119 x 19 ¹ / ₂ (3023 x 496)

TUC & TWT - Composite

Description	Dimensions (W x D)
FULL TOP CUTTING BOARDS 1/2" (13mm) THICK (requires brackets)	
TUC-27-HC	27 ¹ / ₂ x 30 (699 x 762)
TUC-36-HC	36 ¹ / ₂ x 30 (915 x 762)
TUC-44-HC	44 ¹ / ₄ x 32 ¹ / ₂ (1124 x 816)
TUC-48-HC	48 x 30 (1524 x 762)
TUC-60-HC	60 x 30 (1524 x 762)
TUC-60-32-HC	60 x 32 ¹ / ₂ (1524 x 816)
TUC-67-HC	67 x 32 ¹ / ₂ (1702 x 816)
TUC-72-HC	72 x 30 (1829 x 762)
TUC-93-HC	93 ¹ / ₄ x 32 ¹ / ₂ (2369 x 816)
TWT-27-HC	27 ¹ / ₂ x 28 ¹ / ₄ (699 x 718)
TWT-36-HC	36 x 28 ¹ / ₄ (915 x 718)
TWT-44-HC	44 ¹ / ₄ x 30 (1124 x 762)
TWT-48-HC	48 x 28 ¹ / ₄ (1220 x 718)
TWT-60-HC	60 x 28 ¹ / ₄ (1524 x 718)
TWT-60-32-HC	60 x 30 (1524 x 762)
TWT-67-HC	67 x 30w (1702 x 762)
TWT-72-HC	72 x 28 ¹ / ₄ (1829 x 718)
TWT-93-HC	93 ¹ / ₄ x 30 (2369 x 762)
"L" Brackets for TUC & TWT Cutting Board (set) w/out rivnut tool	
"L" Brackets for TUC & TWT Cutting Board (set) w/rivnut tool	

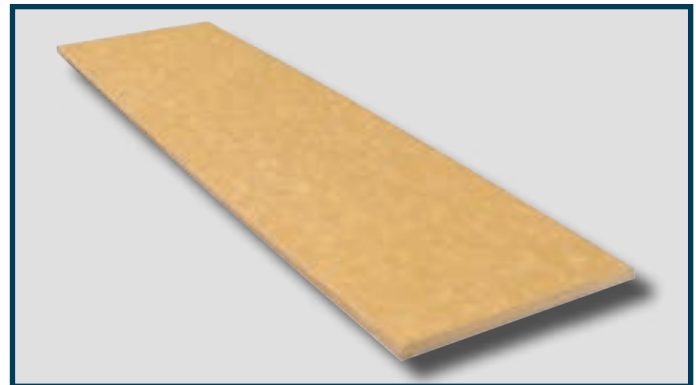

Composite cutting board.



Composite cutting board on cooler.

CONTROLS & DISPLAYS

Digital Display

Description
TSSU/TUC/TWT (-27-HC, -36-HC, -48-HC, -60-HC, -72-HC) - RECTANGULAR
Fahrenheit/Celsius
TPP/DEEP TUC/DEEP TWT (-44-HC, -60-32-HC, -67-HC, -93-HC, -119-HC) - ROUND
Fahrenheit
Celsius



Digital display (TSSU, TFP, TPP, TUC & TWT).
note: TSSU's equipped with crumb catcher option, Digital Display will not be visible.

Thermostat

Description
Chocolate Thermostat 50°F to 55°F (10°C to 13°C)
Red Wine Thermostat 50°F to 55°F (10°C to 13°C)
White Wine Thermostat 45°F to 50°F (7°C to 10°C)



Wine or Chocolate Thermostat

Chocolate/Wine Controls

Description
CW - Must specify Chocolate, Red or White Wine temperature setting

TRM® ACCESSORIES

Peg Hooks

Description	Spacing between pegs
5 pegs	5" (127mm)
6 pegs	4.5" (115mm)
10 pegs	2" (51mm)

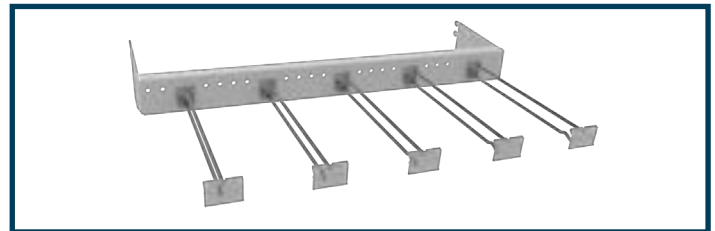

Peg Hooks

Shelves

Description	Dimensions (W x D x H)
Solid Cantilever Shelf	30¼ x 25½ x 7/8 (769 x 648 x 23)



Solid Cantilever Shelf

Corner Kits

Description
Corner Kit (black)



Corner Kit (top)



Corner Kit (Bottom)

OPEN AIR & AIR CURTAIN ACCESSORIES

Night Cover*

Description
TAC NIGHT COVERS
TAC-14GS-HC-LD
THAC NIGHT COVERS
THAC-36-LD (White)
THAC-36-LD (Black)
THAC-36-S-LD (Stainless)
THAC-48-LD (White)
THAC-48-LD (Black)
THAC-48-S-LD (Stainless)
THAC-60-LD (White)
THAC-60-LD (Black)
THAC-60-S-LD (Stainless)

* Night Cover is UL approved with heavy duty return mechanism.
note: Night Cover is standard on TOAM models.

Locking Security Cover*

Description
TOAM-30-HC
TOAM-36-HC
TOAM-48-HC
TOAM-72-HC

* Security cover is not UL approved.
note: Locking security cover adds 6 $\frac{3}{4}$ " (171mm) to cabinet height. Not available for glass sided models. Factory installed only with some field assembly required.

Vandal Cover Panel*

Description
TOAM-30-HC
TOAM-36-HC
TOAM-48-HC
TOAM-72-HC

* Locking removable panel.
note: Not available for glass sided models. Factory installed only with upcharge.

Condensate Heater Pan/Bracket Kits

Description
TOAM-30-HC
TOAM-36-HC
TOAM-48-HC
TOAM-72-HC

note: Black back screen also available, contact factory.

THAC Bumper Guard Kit

Description
THAC-36-HC-LD
THAC-48-HC-LD
THAC-60-HC-LD



Night cover. Standard on TOAM models.



Locking security cover (black).



Vandal Cover Panel.



Cover Open.



Silver.



White.



Condensate Heater Pan/Bracket Kit (pictured without back screen).

DRAFT OPTIONS

Faucet Draft Columns

Description

- Single round faucet draft column
- Double round faucet round draft column
- Triple round faucet round draft column
- Single round nitro draft column
- Double round nitro draft column
- Nitro/Cold brew combo round nitro draft column
- Triple faucet T-style draft column
- Quad faucet T-style draft column
- Draft column hole cover cap*

* Used when draft standard not required (covers hole on countertop).



Single Round



Double Round



Triple Round



Single Nitro



Double Nitro



Nitro/Cold Brew



T-Style Triple



T-Style Quad



Draft Column Hole Cover Cap

Nitro Kits

Description

INDIVIDUALIZED NOMENCLATURE FOR TDD-1-HC VERSIONS

- Nitro Coffee Single-Tap Kit (1 keg / 1 pressure)
- Cold Brew Coffee Single-Tap Kit (1 keg / 1 pressure)
- Nitro Coffee Double-Tap Kit (2 keg / 1 pressure)
- Cold Brew Coffee Double-Tap Kit (2 keg / 1 pressure)
- Nitro & Cold Brew Combination Double-Tap Kit (2 keg / 2 pressure)



Single Cold Brew Kit



Double Cold Brew Kit



Single Nitro Kit



Nitro/Cold Brew
Combo Kit



Double Nitro Kit

PREMIER BAR

Manifolds

Description

- Two-way manifold
- Three-way manifold
- Four-way manifold



Two-way Manifold

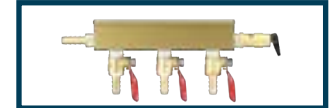

Three-way Manifold

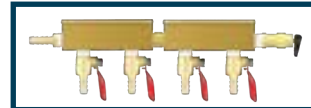

Four-way Manifold

Spill Pans & Grates

Description

- 7" (178mm) Spill pan/grate
- 11" (280mm) Spill pan/grate
- 15" (381mm) Spill pan/grate (standard)
- 19" (483mm) Spill pan/grate
- 23" (585mm) Spill pan/grate
- 27" (686mm) Spill pan/grate
- 31" (788mm) Spill pan/grate
- 35" (889mm) Spill pan/grate



Spill Pan/Grate

Access Port Plugs

Description

- Access Port Plugs



Access Port Plugs

Locks

Description

- Barrel Lock
- Ratchet Lock



Ratchet & Barrel Locks



Drain Bottle & Hanging Bracket

Draft Drain Bottle

Description

- Draft Drain Bottle & Hanger/Bracket

CO₂ Pressure Regulator

Description

- CO₂ Pressure Regulator

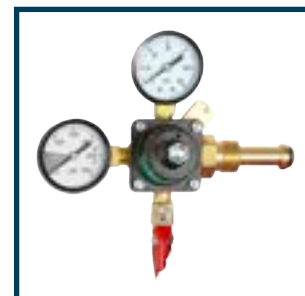

CO₂ Pressure Regulator

PREMIER BAR (cont.)

Shelving Options

Description
Gray Wire Shelves
Black Wire Shelves
Gray Cutout Wire Shelves
Black Cutout Wire Shelves
Wine Shelves
Premier Bar Organizers



Gray Wire Shelf



Gray Cutout Wire Shelf



Wine Shelf



Premier Bar Organizers

COMMERCIAL ICE ACCESSORIES

Water Filters

Description

Standard Water Filter Assembly	14,000 gal (52996 L)
Platinum Water Filter Assembly	35,000 gal (132490 L)



Standard Water Filter



Platinum Water Filter

TrueZone™ Growth Inhibitor

Description

TrueZone™ Growth Inhibitor



TrueZone™ Growth Inhibitor Unit and Bulb.

Adaptor Top

Description

8" (204mm) Adaptor Top - 22" (559mm) Head on 30" (762mm) Bin
--



8" Adaptor Top

Accessories | TDM™/TGM™ Options

TDM™/TGM™ OPTIONS

TDM™ Rear Ratchet Locks (kit) & Front Glass Barrel Lock (frontal glass)

Description

All TDM models

note: Factory installed only.

Top Service Shelves

Description

TDM/TGM-36/48/59/77 Scale Shelf

TDM/TGM-36/48/59 Small Top Service Shelf

TDM/TGM-77 Small Top Service Shelf

TDM/TGM-36/48/59/77 Medium Top Service Shelf

TDM/TGM-48/59/77 Large Top Service Shelf (Not Available on TDM/TGM-36)

note: Factory installed only.

Banking Kit

Description

All TDM/TGM models

Electrical Receptacle

Description

TDM-36/TGM-36

TDM-48/ TGM-48

TDM-59/TGM-59

TDM-77/TGM-77

note: Factory installed only.

External Front Shelf Kit (black only)

Description

TDM-36/TGM-36

TDM-48/ TGM-48

TDM-59/TGM-59

TDM-77/TGM-77

note: Factory installed only.

External Rear Shelf Kit (black only)

Description

TDM-36/TGM-36

TDM-48/ TGM-48

TDM-59/TGM-59

TDM-77/TGM-77

note: Factory installed only.



Ratchet lock.



Front glass lock.



Scale shelf

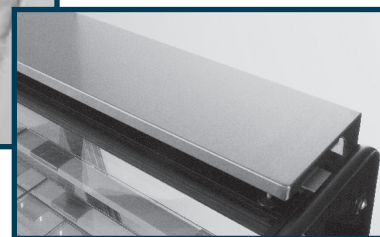

Top service shelf



TDM banking kit.



Electrical Receptacle

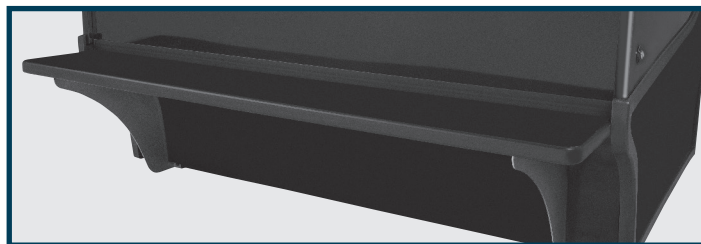

External front shelf

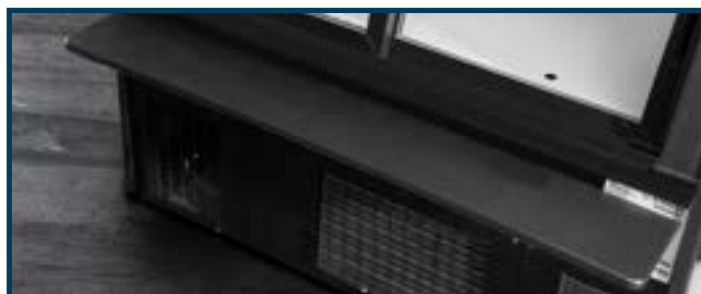

External rear shelf

Clear Glass Shelves Assembly

Description

TDM & TGM-R-36 / TDM & TGM-DC-36
 TDM & TGM-R-48 / TDM & TGM-DC-48
 TDM & TGM-DZ-48
 TDM & TGM-R-59 / TDM & TGM-DC-59
 TDM & TGM-DZ-59
 TDM & TGM-R-77 / TDM & TGM-DC-77
 TDM & TGM-DZ-77

note: Kit includes three (3) levels of shelving.

Frosted Glass Shelves Assembly

Description

TDM & TGM-R-36 / TDM & TGM-DC-36
 TDM & TGM-R-48 / TDM & TGM-DC-48
 TDM & TGM-DZ-48
 TDM & TGM-R-59 / TDM & TGM-DC-59
 TDM & TGM-DZ-59
 TDM & TGM-R-77 / TDM & TGM-DC-77
 TDM & TGM-DZ-77

note: Kit includes three (3) levels of shelving.

Stainless Steel Shelves Assembly (mezzanine)

Description

TDM & TGM-R-36 / TDM & TGM-DC-36
 TDM & TGM-R-48 / TDM & TGM-DC-48
 TDM & TGM-DZ-48
 TDM & TGM-R-59 / TDM & TGM-DC-59
 TDM & TGM-DZ-59
 TDM & TGM-R-77 / TDM & TGM-DC-77 (top/middle/bottom)
 TDM & TGM-DZ-77

note: Kit includes three (3) levels of shelving.

Chrome Shelves Assembly

Description

TDM & TGM-R-36 / TDM & TGM-DC-36
 TDM & TGM-R-48 / TDM & TGM-DC-48
 TDM & TGM-DZ-48
 TDM & TGM-R-59 / TDM & TGM-DC-59
 TDM & TGM-DZ-59
 TDM & TGM-R-77 / TDM & TGM-DC-77 (top/middle/bottom)
 TDM & TGM-DZ-77

note: Kit includes three (3) levels of shelving.

Castors

Description

ALL TDM & TGM-36/48/59 MODELS (not available for 77 models)
 4" (102mm) castor kit
 2½" (64mm) castor kit

Legs

Description

ALL TDM & TGM-36/48/59 MODELS (not available for 77 models)
 6" (153mm) castor kit



Glass Shelves



Frosted Glass Shelves



Stainless Steel Shelves (mezzanine)



Chrome Shelves



4" (102 mm) castors

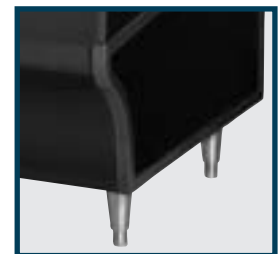

6" (153 mm) legs

LOCKS

Ratchet Locks (factory installed)

Description	Number of Locks
Each GDM, TSD (2 door slide models)	1
Each GDM-69-HC-LD, TSD-69	2
Each TDM (rear doors)	1
Each TGM	1
Each TCGG	1
Each TBB (2 door slide models)	1
Each TBB (3 door slide models)	2

Barrel Locks (factory installed)

Description
GDM / FLM (one door)*
GDM / FLM (two door)
GDM / FLM (three door)
GDM, TSD (slide two door models)

*Available only for one-door swing and slide two door refrigerators (not available for GDM-09-SQ-HC-LD).
Not available for ice merchandisers.

Bolt Locks (factory installed)

Description
TSSU/TUC/TWT/TPP/TFP (per door section - one lock)
TSSU/TUC/TWT/TPP/TFP/TRCB (per drawers section - two locks)

Padlocks

Description
GDM (two swing door models)



Padlock



Ratchet Lock

Ratchet Lock Kit

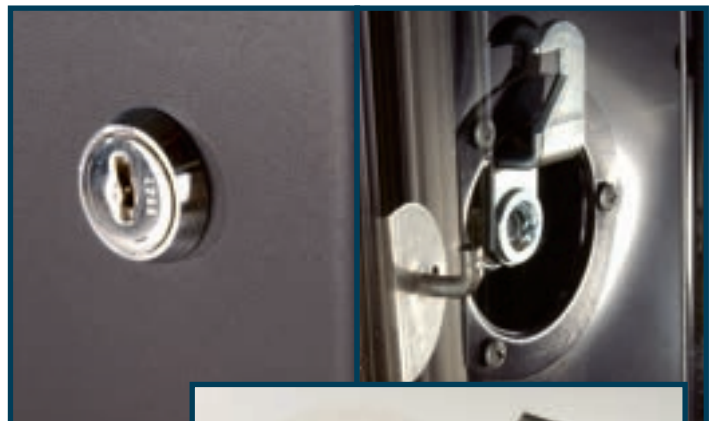

Barrel Lock



Barrel Lock Kit

ADDITIONAL ACCESSORIES

Tray Slides

Description

Deep TUC

Deep TWT

Deep TPP



Tray Slides

Corner Brackets

Description

Flat Top TRCB



Corner Brackets (Flat top TRCB)

Corner Bumpers

Description

TMC



Corner Bumpers (TMC)

Dream in Color

Customize Your Space!

True offers a variety of colors! Choose a color from our curated selection, or create your own custom shade to fit your style and design! Our powder coating and liquid paint finishes ensure a flawlessly smooth surface shielded against chipping and stands the test of time.

True's custom hardware is available in handles, hinges, True logo, and lock hasp on selected units. Choose from timeless classics: brass, chrome, gold, or pewter.



Hardware Packages

Contact True for more details.



Standard curated colors shown.

Custom colors available on request.

handles
finishes
hinges
CUSTOM
powder coat



LEARN MORE



GRAPHIC CAPABILITIES

Drive your sales for bottled drinks, pre-packaged and fresh food, desserts, flowers, and other specialty items with high quality digitally printed signs panels, end and door decals.

- Superior Image Quality
- Vibrant Color Imaging
- White Ink Technology
- Qualified G7 Master Printer



True Stripe Signs are standard on all GDM® models. Availability subject to change. Stainless steel, plain black, plain white and graphic signs are available upon request on most models. Consult factory for details. Upcharges may apply.

REFRIGERATOR SIGNS

		Item# S-BCBV / S-SCBV
		Item# S-BCJ / S-SCJ
		Item# S-BCW / S-SCW
		Item# S-BED / S-SED
		Item# S-BSD / S-SSD
		Item# S-BCB / S-SCB
		Item# S-BW / S-SW
		Item# S-BCM / S-SCM
		Item# S-BMD / S-SMD
		Item# S-BSS / S-SSS
		Item# S-BDF / S-SDF
		Item# S-BS / S-SS
		Item# S-BFS / S-SFS
		Item# S-BD / S-SD
		Item# S-BFRF / S-SFRF
		Item# S-BNC / S-SNC
	WINE	Item# S-TW-16
	DESSERTS BRONZE	Item# S-TD-15
	FLOWERS	Item# S-TF-16
	TRUE STRIPE	Item# S-TS-02

Ice Merchandisers, Wine Merchandisers, Glass Four Sided Merchandisers and Floral Cases come standard with their corresponding designed sign. Alternative signs available at no charge if indicated at the time order is placed and shipped from factory. If sign is ordered after unit leaves the factory, an upcharge will apply. Custom signs/graphics available. Please contact factory for details and pricing.

FREEZER SIGNS

		Item# S-BFZF / S-SFZF
		Item# S-BIC / S-SIC
		Item# S-BI / S-SI
		Item# S-BNC / S-SNC
	SPARKLING ICE	Item# S-TSI-11

VINTAGE UNIT GDM-15-HC-RTO-LD SIGNS



Stainless Steel (Standard)



Wine Red



Market Fresh



Wine Black



Cold Drinks



Wine Gold



* Alternative signs are not field installable and must be indicated at time of order. Please contact customer service for lead time and availability.

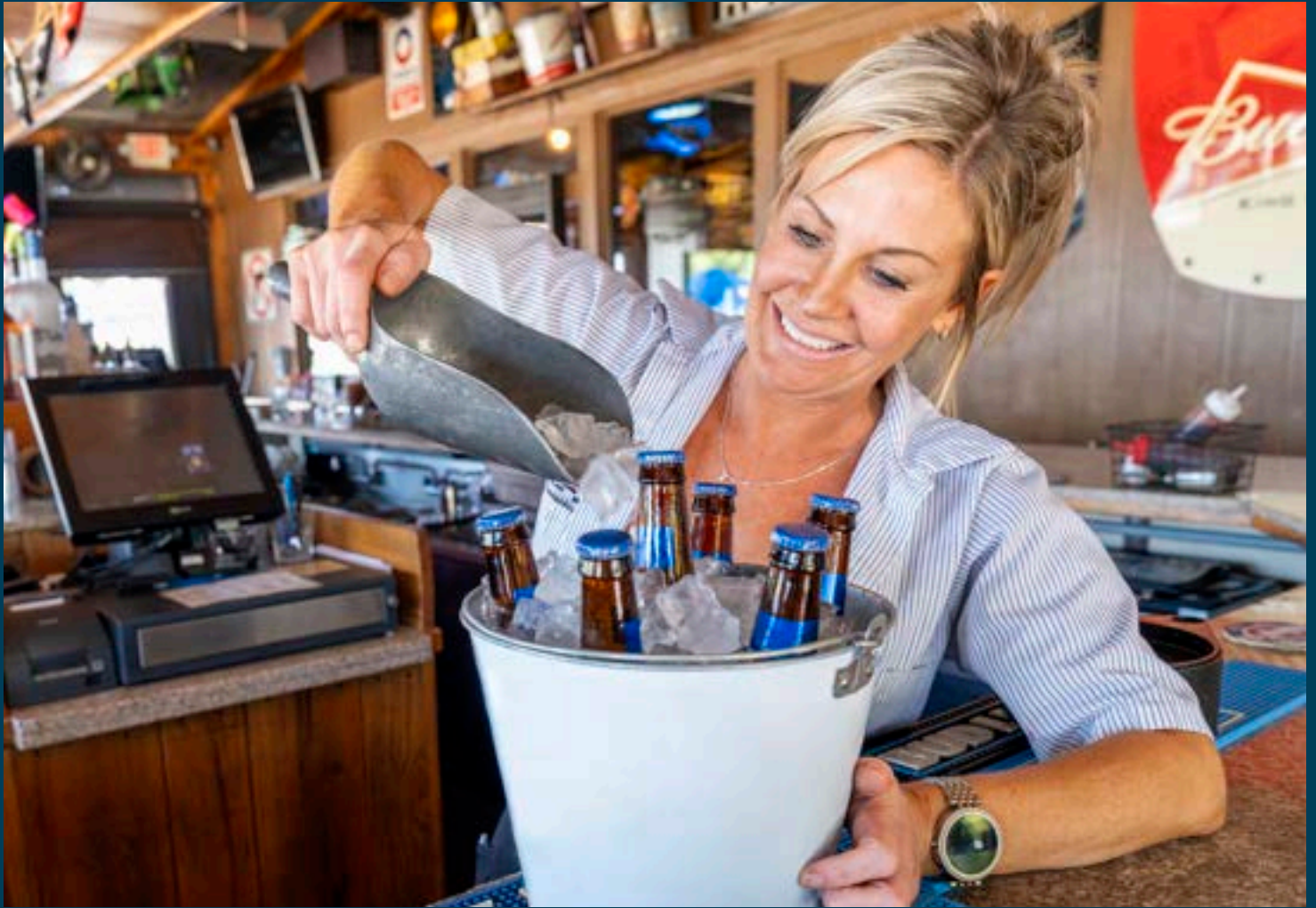





PRODUCT CATALOG

Our extensive support network of True professionals are dedicated to keeping your refrigeration running smoothly.

2001 East Terra Lane, O'Fallon, MO 63366-4434 p: 636.240.2400 f: 636.272.2408 toll free: 800.325.6152 parts toll free: 800.424.8783

truemfg.com |     